

Installation, Operating & Maintenance Instructions



Mini UHV gate valve with pneumatic actuator

Series 010
DN 16 – 50 mm (I. D. 5/8" – 2")

This manual is valid for the following product ordering numbers:
010 .. - -



Sample picture

Imprint

Manufacturer VAT Vakuumventile AG, CH-9469 Haag, Switzerland

Website: www.vatvalve.com
Phone: +41 81 771 61 61
Fax: +41 81 771 48 30
Email: CH@vatvalve.com

Publisher VAT Vakuumventile AG, CH-9469 Haag, Switzerland

Editor VAT Vakuumventile AG, CH-9469 Haag, Switzerland

Print VAT Vakuumventile AG, CH-9469 Haag, Switzerland

Copyright © VAT Vakuumventile AG 2014

No part of these instructions may be reproduced in any way (photocopies, microfilms or any other reproduction processes) nor may it be manipulated with electronic systems, duplicated or distributed without written permission from VAT. Offenders are liable to pay damages.

The original VAT firmware and updated state of the art versions of the VAT firmware are intended for use with VAT products. The VAT firmware contains a limited, time unlimited user license. The VAT firmware may not be used for purposes other than those intended nor is it permitted to make copies of the VAT firmware. In particular, it is strictly forbidden to give copies of the VAT firmware to other people.

The use of trade names, brand names, trademarks, etc. in these Instructions does not entitle third parties to consider these names to be unprotected and to use them freely. This is in accordance with the meaning of the laws and acts covering brand names and trademarks.

Contents

| | | |
|----------|-------------------------------------------------------|-----------|
| 1 | Description of product..... | 5 |
| 1.1 | Identification of product..... | 5 |
| 1.2 | Use of product..... | 5 |
| 1.3 | Related documents..... | 5 |
| 1.4 | Important information..... | 5 |
| 1.5 | Technical data..... | 5 |
| 1.6 | Available actuators..... | 5 |
| 2 | Safety | 6 |
| 2.1 | Compulsory reading material..... | 6 |
| 2.2 | Danger levels..... | 6 |
| 2.3 | Personnel qualifications..... | 7 |
| 2.4 | Safety labels..... | 7 |
| 3 | Design and Function..... | 8 |
| 3.1 | Design..... | 8 |
| 3.2 | Function..... | 8 |
| 4 | Installation | 9 |
| 4.1 | Unpacking..... | 9 |
| 4.2 | Installation into the system..... | 9 |
| 4.2.1 | Admissible forces and bending moments..... | 11 |
| 4.3 | Compressed air connection..... | 12 |
| 4.4 | Electrical connection..... | 12 |
| 5 | Operation | 13 |
| 5.1 | Normal operation..... | 13 |
| 5.2 | Operation under increased temperature..... | 13 |
| 5.3 | Behavior in case of compressed air pressure drop..... | 13 |
| 5.4 | Behavior in case of power failure..... | 13 |
| 5.4.1 | Manual emergency operation..... | 14 |
| 5.5 | Trouble shooting..... | 15 |
| 6 | Maintenance | 16 |
| 6.1 | Maintenance intervals..... | 16 |
| 6.2 | Required tools..... | 16 |
| 6.3 | Cleaning of gate..... | 17 |
| 6.4 | Replacement of gate..... | 19 |
| 7 | Repairs..... | 21 |
| 8 | Dismounting and Storage..... | 22 |
| 8.1 | Dismounting..... | 23 |
| 8.2 | Storage..... | 23 |
| 9 | Packaging and Transport..... | 24 |
| 9.1 | Packaging..... | 25 |
| 9.2 | Transport..... | 25 |

| | | |
|-----------|-------------------------|-----------|
| 10 | Disposal..... | 26 |
| 11 | Spare parts..... | 27 |

1 Description of product

1.1 Identification of product

The fabrication number and order number are fixed on the product directly or by means of an identification plate.



← Fabrication number
← Order number

1.2 Use of product

Use product for clean and dry vacuum applications only. Other applications are only allowed with the written permission of VAT.

1.3 Related documents

- Product data sheet
- Dimensional drawing

1.4 Important information



This symbol points to a very important statement that requires particular attention.

Example:



VAT disclaims any liability for damages resulting from inappropriate packaging.

1.5 Technical data

See product data sheet and dimensional drawing.

1.6 Available actuators

| Double acting | Single acting with closing spring (NC) | Single acting with opening spring (NO) |
|-------------------------------------------------------------------------------------|--------------------------------------------------------------------------------------|---------------------------------------------------------------------------------------|
|  |  |  |

Table 1-1

2 Safety

2.1 Compulsory reading material

Read this chapter prior to performing any work with or on the product. It contains important information that is significant for your own personal safety. This chapter must have been read and understood by all persons who perform any kind of work with or on the product during any stage of its serviceable life.

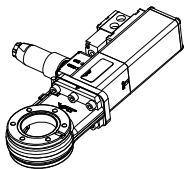
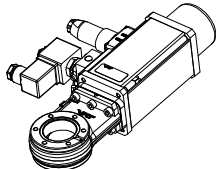
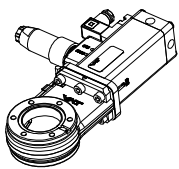
| | |
|--|--------------------------------------------------------------------------------------------------------------------------------------------|
| | NOTICE |
| | <p>Lack of knowledge Failing to read this manual may result in property damage. Firstly, read manual.</p> |

These Installation, Operating & Maintenance Instructions are an integral part of a comprehensive documentation belonging to a complete technical system. They must be stored together with the other documentation and accessible for anybody who is authorized to work with the system at any time.

2.2 Danger levels

| | |
|--|-------------------------------------------------------------------------------------------------------------------------------------|
| | ⚠ DANGER |
| | <p>High risk Indicates a hazardous situation which, if not avoided, will result in death or serious injury.</p> |

| | |
|--|----------------------------------------------------------------------------------------------------------------------------------------|
| | ⚠ WARNING |
| | <p>Medium risk Indicates a hazardous situation which, if not avoided, could result in death or serious injury.</p> |

| | |
|--|------------------------------------------------------------------------------------------------------------------------------------|
| | ⚠ CAUTION |
| | <p>Low risk Indicates a hazardous situation which, if not avoided, may result in minor or moderate injury.</p> |

| | |
|--|--------------------------------------------------------------------------------------------------------------------------|
| | NOTICE |
| | <p>Command Indicates a hazardous situation which, if not avoided, may result in property damage.</p> |

2.3 Personnel qualifications

| |  WARNING |
|-----------------------------------------------------------------------------------|------------------------------------------------------------------------------------------------------------------------------------------------------------------------------|
|  | Unqualified personnel Inappropriate handling may cause serious injury or property damage. Only qualified personnel are allowed to carry out the described work. |

2.4 Safety labels

| Label | Part No. | Location on valve |
|-----------------------------------------------------------------------------------|------------|-------------------|
|  | T-9001-155 | Protective cover |

Table 2-1

3 Design and Function

3.1 Design

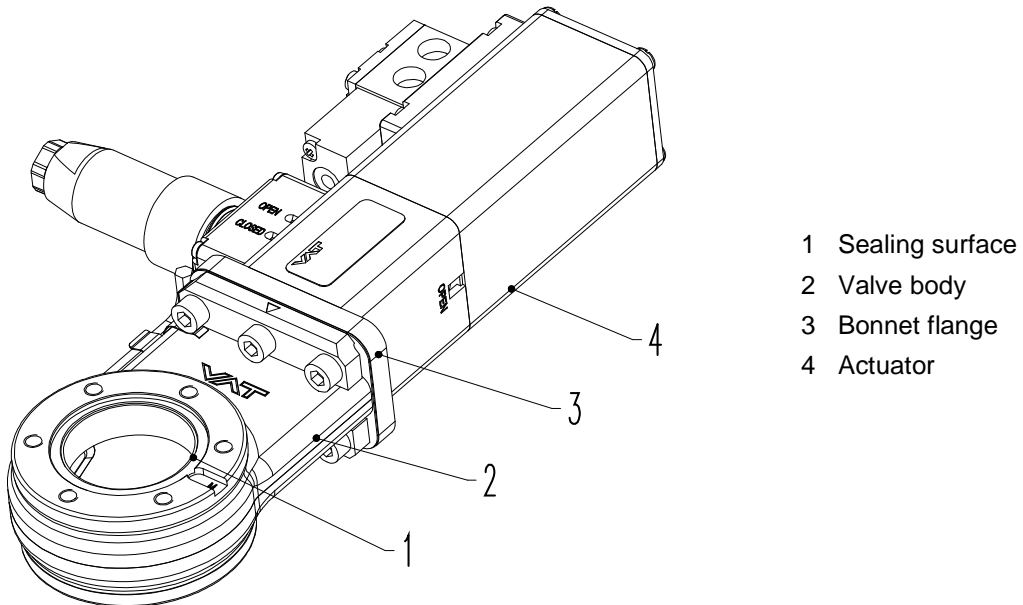

Figure 3-1

3.2 Function

The valve features the MONOVAT sealing technology and a pneumatic actuator. With the additional air pressure tank the valve will stay in the closed position for a defined time even when compressed air and electrical power is missing; see «Figure 3-2».

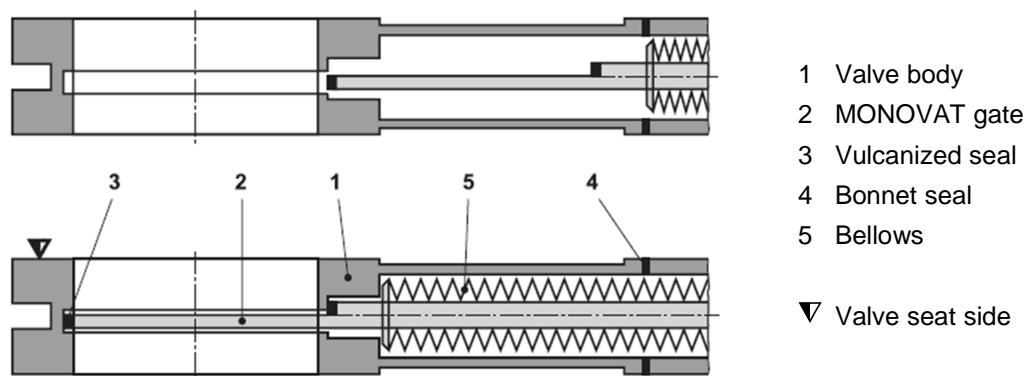



Figure 3-2

4 Installation

| | |
|-----------------------------------------------------------------------------------|---------------------------------------------------------------------------------------------------------------------------------------------------------------------------------------|
|  | WARNING |
| | <p>Unqualified personnel Inappropriate handling may cause serious injury or property damage. Only qualified personnel are allowed to carry out the described work.</p> |

4.1 Unpacking



- Make sure that the supplied products are in accordance with your order.
- Inspect the quality of the supplied products visually. If it does not meet your requirements, please contact VAT immediately.
- Store the original packaging material. It may be useful if products must be returned to VAT.

4.2 Installation into the system

| | |
|-------------------------------------------------------------------------------------|----------------------------------------------------------------------------------------------------------------------------------------------------------------------------------------------------------------|
|  | WARNING |
| | <p>Movable parts Human body parts may get jammed and severely injured. Do not connect or supply electrical power and compressed air before the product is completely mounted in the system.</p> |

| | |
|-------------------------------------------------------------------------------------|---------------------------------------------------------------------------------------------------------------------------|
|  | NOTICE |
| | <p>Contamination Product may get contaminated. Always wear cleanroom gloves when handling the product.</p> |

| | |
|--|----------------------------------------------------------------------------------------------------------------------------------------------|
| | NOTICE |
| | <p>Inappropriate tools Sealing surfaces may get damaged. Do not use sharp-edged tools.</p> |
| | NOTICE |
| | <p>Wrong tightening torque Valve body and screws may get damaged. Use tightening torque according the size of the screws.</p> |
| | NOTICE |
| | <p>Too long screws Valve body may get deformed and / or malfunctions may occur. Use only screws recommended by VAT.</p> |

Maximum screw-in depth:

| Valve | | | Maximum screw-in depth «X» in mm | | | | |
|------------|------|-----|----------------------------------|--|----------|--|--|
| | | | Flanges | | | | |
| Nom. I. D. | | | CF-F metric | | CF-F UNF | | |
| mm | inch | | | | | | |
| 16 | 5/8 | X = | 7 | | 7 | | |
| 25 | 1 | X = | N/A | | N/A | | |
| 40 | 1½ | X = | 7 | | 7 | | |
| 50 | 2 | X = | N/A | | N/A | | |

Table 4-1

1. Remove protective covers from body flanges.
2. Clean sealing surfaces and seals of both flanges; see (1) and (2) according to «Figure 4-1» on page 11.



The valve seat side is marked with the symbol «▽» on flange «A».

3. Put valve to the mounting position.
4. Mount the 6 screws (or clamping ring) according to «Figure 4-1» on page 11, evenly in crosswise order until the seal touches the sealing surface.
5. Tighten all screws with a torques appropriate for their property classes.



- 1 Flange A
- 2 Flange B
- 3 Thread in flange

Figure 4-1

4.2.1 Admissible forces and bending moments



Forces from evacuating the system, from the weight of other components or from baking can lead to deformation of the valve body and to malfunction of the valve. The stress has to be relieved by suitable means, e.g. bellows sections.

The following forces or moments are admissible:

| DN (nom. I. D.) | | Axial tensile or compressive force «FA» | | Bending moment «M» | |
|-----------------------------------------------------------------------------------------------------------------------------------------|------|-----------------------------------------|-----|--------------------|----------|
| mm | inch | N | lbf | Nm | lbf · ft |
| 16 | 5/8 | 500 | 112 | 30 | 22 |
| 25 | 1 | 500 | 112 | 30 | 22 |
| 40 | 1½ | 500 | 112 | 30 | 22 |
| 50 | 2 | 500 | 112 | 30 | 22 |
| If a combination of both forces («FA» and «M») occurs, the values mentioned above are invalid. Please contact VAT for more information. | | | | | |

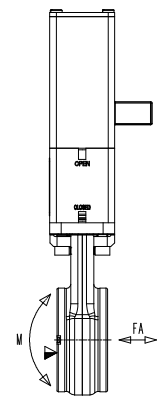



Table 4-2

4.3 Compressed air connection

|  WARNING | |
|--------------------------------------------------------------------------------------------------|---------------------------------------------------------------------------------------------------------------------------------------------------------------------------------------------------------------------------------------------------------------------------------------|
|  | <p>Valve in open position</p> <p>Risk of injury when compressed air is connected to the valve.</p> <p>Connect compressed air only when:</p> <ul style="list-style-type: none">– valve is installed in the vacuum system– moving parts cannot be touched |





Use clean, dry or slightly oiled air only.



Admissible air pressure range, see product data sheet.



1. Connect compressed air according to the product data sheet and dimensional drawing.

4.4 Electrical connection

|  NOTICE | |
|---------------------------------------------------------------------------------------------------|-----------------------------------------------------------------------------------------------------------------------------------------|
|  | <p>Wrong voltage</p> <p>Electrical components may get damaged.</p> <p>Supply electrical components with the correct voltage.</p> |

1. Connect solenoid valve according to the product data sheet and dimensional drawing.
2. Connect position indicator according to the product data sheet and dimensional drawing.
3. Connect heater (option) according to the product data sheet and dimensional drawing.

5 Operation

| | |
|-----------------------------------------------------------------------------------|-------------------------------------------------------------------------------------------------------------------------------------------------------------------------------------------------------------------------------------------|
|  | <p style="text-align: center;">⚠ WARNING</p> <p>Unqualified personnel Inappropriate handling may cause serious injury or property damage. Only qualified personnel are allowed to carry out the described work.</p> |
|  | <p style="text-align: center;">⚠ WARNING</p> <p>Movable parts Human body parts may get jammed and severely injured. Do not operate before product is installed completely into the vacuum system.</p> |
|  | <p style="text-align: center;">⚠ WARNING</p> <p>Hot surfaces Risk of burning when touching hot surfaces. Do not touch hot surfaces.</p> |

5.1 Normal operation

See product data sheet.

5.2 Operation under increased temperature

Maximum allowed temperature, see product data sheet.

Note:

After bake-out check and re-torque the bonnet screws. Do tighten screws crosswise!
Necessary torque of screws for DN 16 – DN 50; 10 Nm / 7.4 lbf · ft.

5.3 Behavior in case of compressed air pressure drop

See product data sheet.

5.4 Behavior in case of power failure

See product data sheet.

5.4.1 Manual emergency operation

| | |
|-----------------------------------------------------------------------------------|----------------------------------------------------------------------------------------------------------------------------------------------------------------------------|
|  | ⚠ WARNING |
| | <p>Movable parts Human body parts may get jammed and severely injured. Keep human body parts away from movable parts.</p> |

In case of a power failure, the valve can be actuated manually if compressed air is available.

Standard solenoid valve

Only valid for ordering No. 010...-..34/44

Only valid for ordering No. 010...-..31/41



Press push-button: valve opens
 Release push-button: valve closes



Turn screw (1) in CW order: valve opens
 Turn screw (1) in CCW order: valve closes

Option:
Solenoid valve with lockable emergency operation

Only valid for ordering No. 010...-..34/44



Standard solenoid valve with manual emergency operation (5)

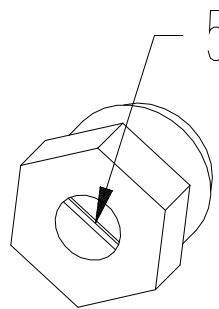

Solenoid valve in "NORMAL" position

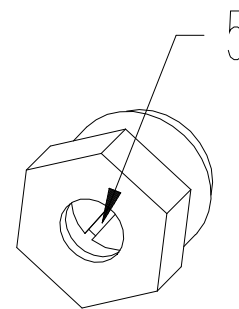

Solenoid valve in "MANUAL" position (push and turn 90°)

Option:
Solenoid valve for impulse actuation
 Only valid for ordering No. 010...34/44

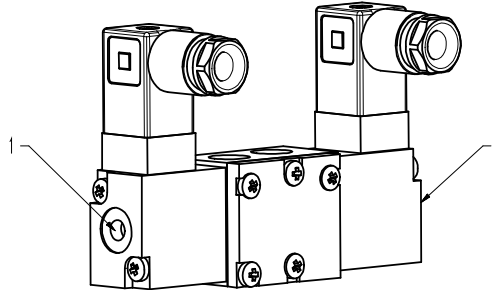

Press push-button (1): valve opens
 Press push-button (2): valve closes



5.5 Trouble shooting

| Failure | Check | Action | See |
|-----------------------------|--------------------------------------------|-----------------------------------------------|--------------------------------------------------------------|
| Valve does not close / open | Air pressure | Connect compressed air | «4.3 Compressed air connection Compressed air connection» |
| | Operating pressure | Adjust operating pressure | Product data sheet |
| | Voltage at solenoid valve | Connect voltage | «4.4 Electrical connection» |
| Leak at gate | Gate seal all right? | Cleaning valve gate | «6.3 Cleaning of gate» |
| | Gate damaged or contaminated? | Replace valve gate | «6.4 Replacement of gate» |
| | Operating pressure | Adjust operating pressure | Product data sheet |
| Leak at body | Bonnet seal and sealing surface all right? | Clean sealing surface and replace bonnet seal | «6.3 Cleaning of gate» |
| | Bellows all right? | Contact VAT | www.vatvalve.com |

Table 5-1

If you need any further information, please contact one of our service centers. You will find the addresses on our website www.vatvalve.com.

6 Maintenance

| | |
|------------------------------------------------------------------------------------|-------------------------------------------------------------------------------------------------------------------------------------------------------------------------------------------------------------------------------------------------------------------|
|  | <p style="text-align: center;">⚠ WARNING</p> <p>Unqualified personnel Inappropriate handling may cause serious injury or property damage. Only qualified personnel are allowed to carry out the described work.</p> |
|  | <p style="text-align: center;">⚠ WARNING</p> <p>Hazardous components Human body parts may get jammed and severely injured. Before starting maintenance: – disconnect compressed air supply – disconnect electrical power supply</p> |
|  | <p style="text-align: center;">⚠ WARNING</p> <p>Movable parts Human body parts may get jammed and severely injured. Keep human body parts away from movable parts.</p> |

6.1 Maintenance intervals

Under clean operating conditions the valve does not require any maintenance during the specified cycles; see product data sheet. After these cycles, VAT recommends replacing the gate; see chapter «6.4 Replacement of gate».

For more information or a general overhaul please contact one of our service centers. You will find the addresses on our website www.vatvalve.com.

6.2 Required tools

- Torque wrench; 10 Nm
- Cleanroom wiper soaked with alcohol (2% methyl ethyl ketone)
- Puncher; 3 mm
- Allen wrench; 4 mm

6.3 Cleaning of gate

| NOTICE | |
|---------------|-------------------------------------------------------------------------------------------------------------------------------------------------------------------------------------------------------------|
| | <p>Contamination</p> <p>Make sure that the supplied spare parts are in accordance with your order. Product may get contaminated. Always wear cleanroom gloves when handling the product.</p> |

| NOTICE | |
|---------------|--------------------------------------------------------------------------------------------------------------|
| | <p>Inappropriate tools</p> <p>Sealing surfaces may get damaged. Do not use sharp-edged tools.</p> |

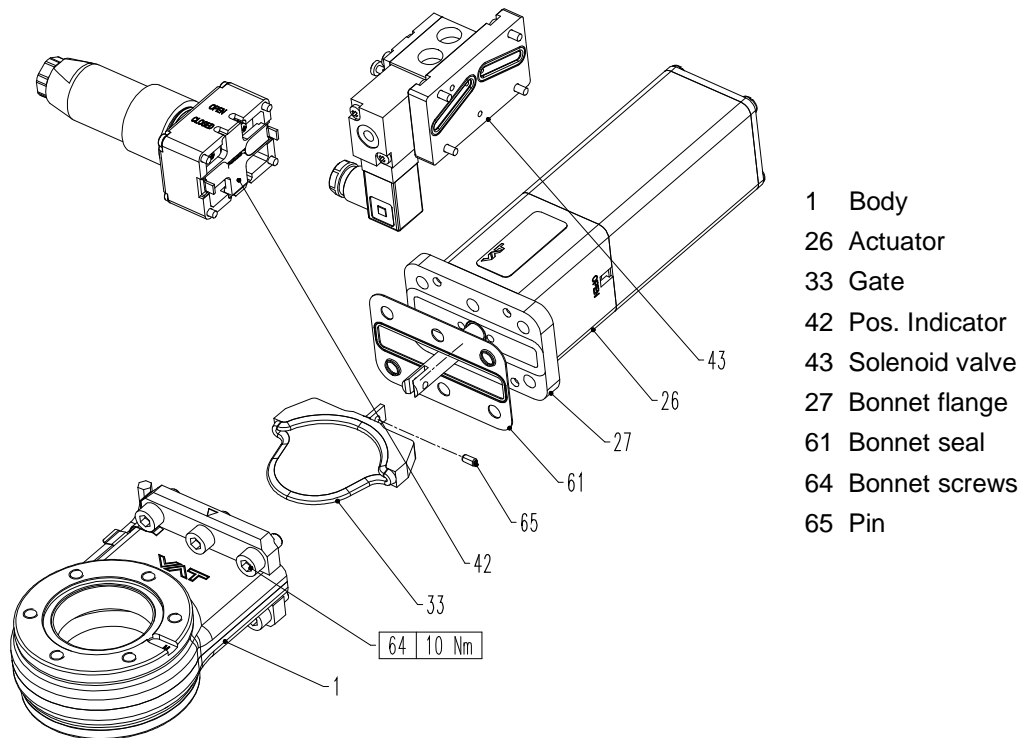

Figure 6-1

1. Close the valve.
2. Vent chambers on either side to atmospheric pressure.
3. Disconnect compressed air supply.
4. Disconnect electrical power supply.
5. Remove bonnet screws (64); see «Figure 6-1» on page 17.
6. Withdraw actuator / mechanism unit carefully from body; see «Figure 6-1» on page 17.



Do not touch the body wall.

7. Clean gate seal (33) and replace bonnet seal (61); see «Figure 6-1» on page 17.
8. Clean seat and bonnet seal surface of the valve body (1); see «Figure 6-1» on page 17, with cleanroom wiper.
9. Insert actuator / mechanism unit into body without touching the body wall.
10. Mount screws (64) according to «Figure 6-1» on page 17.
11. Tighten screws (64) in crosswise order (from inside to outside) with a torque of **10 Nm / 7.4 lbf · ft**.
12. Connect compressed air supply.
13. Connect electrical power supply.

Valve is ready for use.

6.4 Replacement of gate

1. Close the valve.
2. Vent chambers on either side to atmospheric pressure.
3. Disconnect compressed air supply.
4. Disconnect electrical power supply.
5. Remove bonnet screws (64); see «Figure 6-1» on page 17.
6. Withdraw actuator / mechanism unit carefully from body; see «Figure 6-1» on page 17.



Do not touch the body wall.

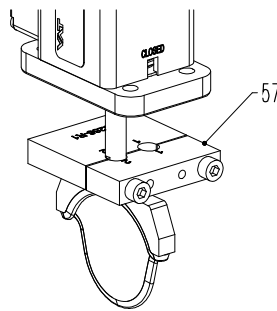
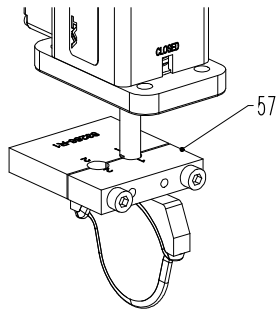

Tool (remove pin; borehole 1)

Tool (insert pin; borehole 2)

Orientation slot opening

Figure 6-2

7. The pin (65) is removed by using borehole 1 from tool (57); see «Figure 6-2».
8. Clamp the shaft by means of tool (57) according drawing; see «Figure 6-2».
9. Make sure that the tool (57) is clamped with borehole 1 onto the shaft before removing pin (65); see «Figure 6-2».
10. Remove pin (65) using a 3 mm punch tool.
11. Release tool (57) from shaft.
12. Exchange the gate maintaining the correct orientation.
13. The pin (65) is inserted by using borehole 2 from tool (57); see «Figure 6-2».
14. Clamp the shaft by means of tool (57) according drawing; see «Figure 6-2».
15. Insert new pin (65) into borehole 2 from tool (57) and make sure that the slot opening of the pin is in the direction of the gate /actuator. An incorrect orientated pin may result in a damage of the valve; see «Figure 6-2».

16. Insert pin (65) using 3 mm punch tool.
17. Release tool (57) from shaft.
18. Make sure that pin (65) is fully inside the shaft and does not protrude.
19. Clean bonnet seal surface and replace bonnet seal (61); see «Figure 6-1» on page 17.
20. Insert actuator / mechanism unit into body without touching the body wall.
21. Mount screws (64) according to «Figure 6-1» on page 17.
22. Tighten screws (64) in crosswise order (from inside to outside) with a torque of **10 Nm / 7.4 lbf · ft.**
23. Connect compressed air supply.
24. Connect electrical power supply.





Valve is ready for use.

7 Repairs

Repairs may only be carried out by the VAT service staff. In exceptional cases, the customer is allowed to carry out the repairs, but only with the prior consent of VAT.

Please contact one of our service centers. You will find the addresses on our website www.vatvalve.com.

8 Dismounting and Storage

| | |
|-------------------------------------------------------------------------------------|----------------------------------------------------------------------------------------------------------------------------------------------------------------------------------------------------------------------------------------------------------------------------------------------------------------------------------------------------------|
|  | <p style="text-align: center;">⚠ WARNING</p> <p>Unqualified personnel Inappropriate handling may cause serious injury or property damage. Only qualified personnel are allowed to carry out the described work.</p> |
|  | <p style="text-align: center;">⚠ WARNING</p> <p>Hazardous components Human body parts may get jammed and severely injured. Before dismounting the product</p> <ul style="list-style-type: none"> – disconnect compressed air supply – disconnect electrical power supply |
|  | <p style="text-align: center;">⚠ WARNING</p> <p>Movable parts Human body parts may get jammed and severely injured. Keep human body parts away from movable parts.</p> |
|  | <p style="text-align: center;">⚠ WARNING</p> <p>Hot surfaces Risk of burning when touching hot surfaces. Touch hot surfaces only if the valve has cooled down.</p> |
|  | <p style="text-align: center;">NOTICE</p> <p>Contamination Product may get contaminated. Always wear cleanroom gloves when handling the product.</p> |

8.1 Dismounting

| | |
|-----------------------------------------------------------------------------------|----------------------------------------------------------------------------------------------------------------------------------------------------------------------|
|  | NOTICE |
| | <p>Valve in open position Valve mechanism may get damaged if valve is in open position. Close valve before dismounting the valve from the system.</p> |

1. Close valve.
2. Carry out the steps according to «4 Installation» in reverse order.
Pay attention to the safety instructions!

8.2 Storage

| | |
|------------------------------------------------------------------------------------|----------------------------------------------------------------------------------------------------------------------------------------------------------------------------------------------------------------------------------------------------------------|
|  | NOTICE |
| | <p>Wrong storage Inappropriate temperatures and humidity may cause damage to the product. Valve must be stored at: – relative humidity between 10% and 70% – temperature between +10 °C and +50 °C – non-condensing environment</p> |

| | |
|-------------------------------------------------------------------------------------|---------------------------------------------------------------------------------------------------------------------------------------------------------------------------------------------|
|  | NOTICE |
| | <p>Inappropriate packaging Product may get damaged if inappropriate packaging material is used. Always use the original packaging material and handle product with care.</p> |

1. Clean / decontaminate valve.
2. Cover all valve openings with the protective cover.
3. Pack valve appropriately by using the original packaging material.

9 Packaging and Transport

| | |
|-----------------------------------------------------------------------------------|-------------------------------------------------------------------------------------------------------------------------------------------------------------------------------------------------------------------------------------------------------------------------------|
|  | <p style="text-align: center;">WARNING</p> <p>Unqualified personnel Inappropriate handling may cause serious injury or property damage. Only qualified personnel are allowed to carry out the described work.</p> |
|  | <p style="text-align: center;">WARNING</p> <p>Harmful substances Risk of injury in case of contact with harmful substances. Remove harmful substances (e. g. toxic, caustic or microbiological ones) from valve before you return the valve to VAT.</p> |
|  | <p style="text-align: center;">NOTICE</p> <p>Inappropriate packaging Product may get damaged if inappropriate packaging material is used. Always use the original packaging material and handle product with care.</p> |



- When returning products to VAT, please fill out the VAT form «Declaration of Chemical Contamination» and send it to VAT in advance. The form can be downloaded from our website www.vatvalve.com.
- If products are radioactively contaminated, the VAT form «Contamination and Radiation Report» must be filled out. Please contact VAT in advance.
- If products are sent to VAT in contaminated condition, VAT will carry out the decontamination procedure at the customer's expense.

9.1 Packaging

| NOTICE | |
|-----------------------------------------------------------------------------------|------------------------------------------------------------------------------------------------------------------------------------------------|
|  | <p>Valve in open position Valve mechanism may get damaged if valve is in open position. Make sure that the valve is closed.</p> |

1. Cover all valve openings with the protective cover.
2. Pack valve appropriately, by using the original packaging material.



VAT disclaims any liability for damages resulting from inappropriate packaging.

9.2 Transport

| NOTICE | |
|-------------------------------------------------------------------------------------|---------------------------------------------------------------------------------------------------------------------------------------------------------------------------------------------|
|  | <p>Inappropriate packaging Product may get damaged if inappropriate packaging material is used. Always use the original packaging material and handle product with care.</p> |



VAT disclaims any liability for damages resulting from inappropriate packaging.

10 Disposal

| | | |
|-----------------------------------------------------------------------------------|----------------------------------------------------------------------------------------------------------------------------------|--|
|  | ⚠ WARNING | |
| | <p>Harmful substances Environmental pollution. Discard products and parts according to the local regulations.</p> | |

11 Spare parts

| NOTICE | |
|---------------|--------------------------------------------------------------------------------------------------------------------------------------------------------------------------------------------|
| | <p>Non-original spare parts Non-original spare parts may cause damage to the product. Use original spare parts from VAT only.</p> |



- Please specify the fabrication number of the product when you place an order for spare parts; see chapter «1.1 Identification of product». This is to ensure that the appropriate spare parts are supplied.
- VAT makes a difference between spare parts that may be replaced by the customer and those that need to be replaced by the VAT service staff.
- «Table 11-1» only contains spare parts that may be replaced by the customer. If you need any other spare parts, please contact one of our service centers. You will find the addresses on our website www.vatvalve.com.

| Description | Part No. | Quantity per valve | Maintenance procedure see chapter |
|--------------------------------------------------------|------------|--------------------|-----------------------------------|
| Bonnet seal | On request | 1 | «6.4 Replacement of gate» |
| Gate including pin | On request | 1 | «6.4 Replacement of gate» |
| Seal kit vacuum 1x Bonnet seal 1x Gate 1x Pin | On request | 1 | «6.4 Replacement of gate» |
| Tool | 83266-R1 | 1 | «6.4 Replacement of gate» |

Table 11-1