

This drawing is the property of VAT.

Revision

Customer number

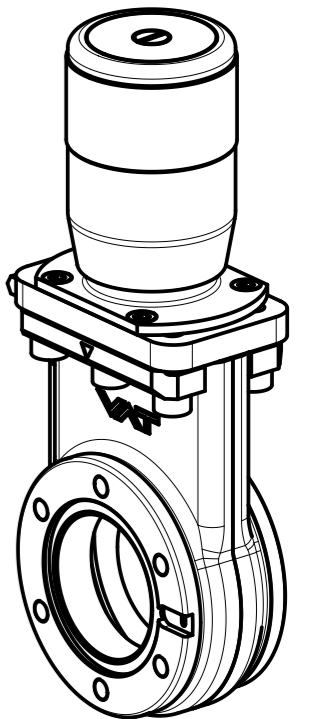
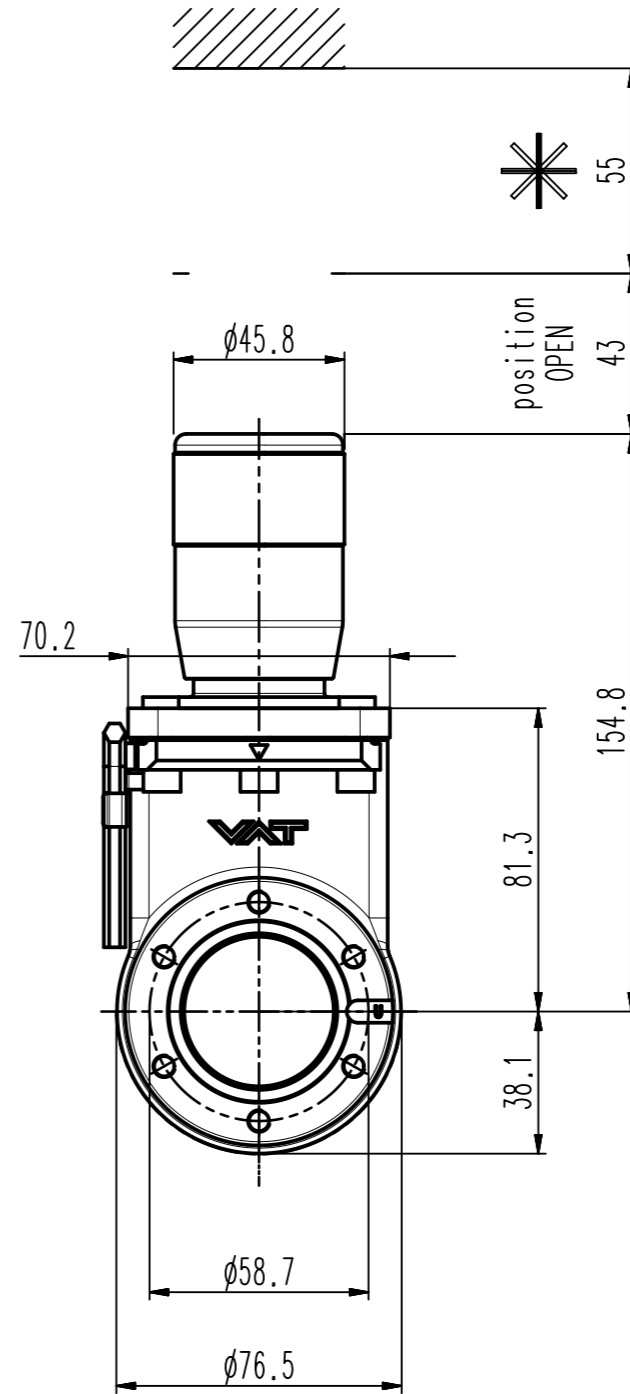
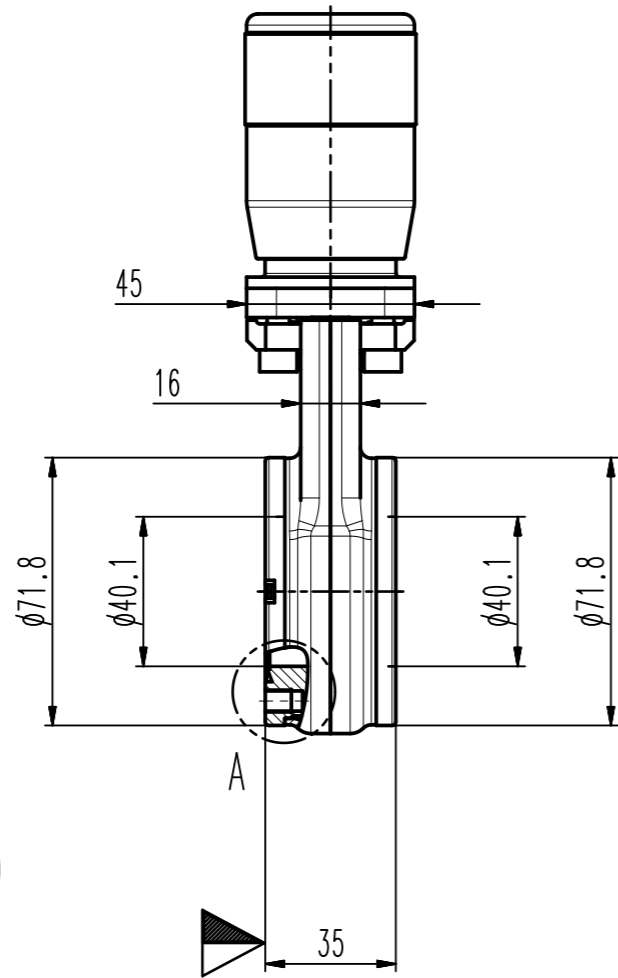
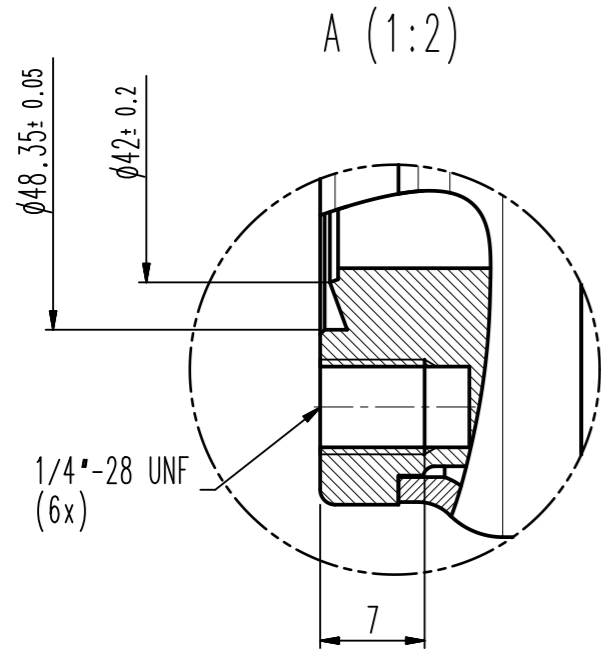

- ▼ Seat side
- ⊙ Comp. air connection
- ⊙ Electrical connection
- ⊙ Leak detection port
- ⊙ Mech. pos. indication
- ⊙ Position indicator
- ⊙ Required for dismantling
- ⊙ Emergency actuation
- ⊙ For attachment
- ⊙ Bake-out area
- ⊙ Differential pumping port

Mini UHV gate valve



VAT Vakuumventile AG

CH-9469 Haag, Switzerland
Tel ++41 81 7716161 Fax ++41 81 7714830

Rev.-Date: 26.05.16

Visa: KON

Series	010	Ordering No.	01032-UE01-0002
Projection E	DN	Flange	
	40	CF-F UNF	
Dimensional Drawing	315895	Rev.	A