

## Transfer valve L-MOTION insert with double acting pneumatic actuator

### Series 053

This manual is valid for the following product ordering numbers:

**053..-L...-.....**

**053..-M...-.....**

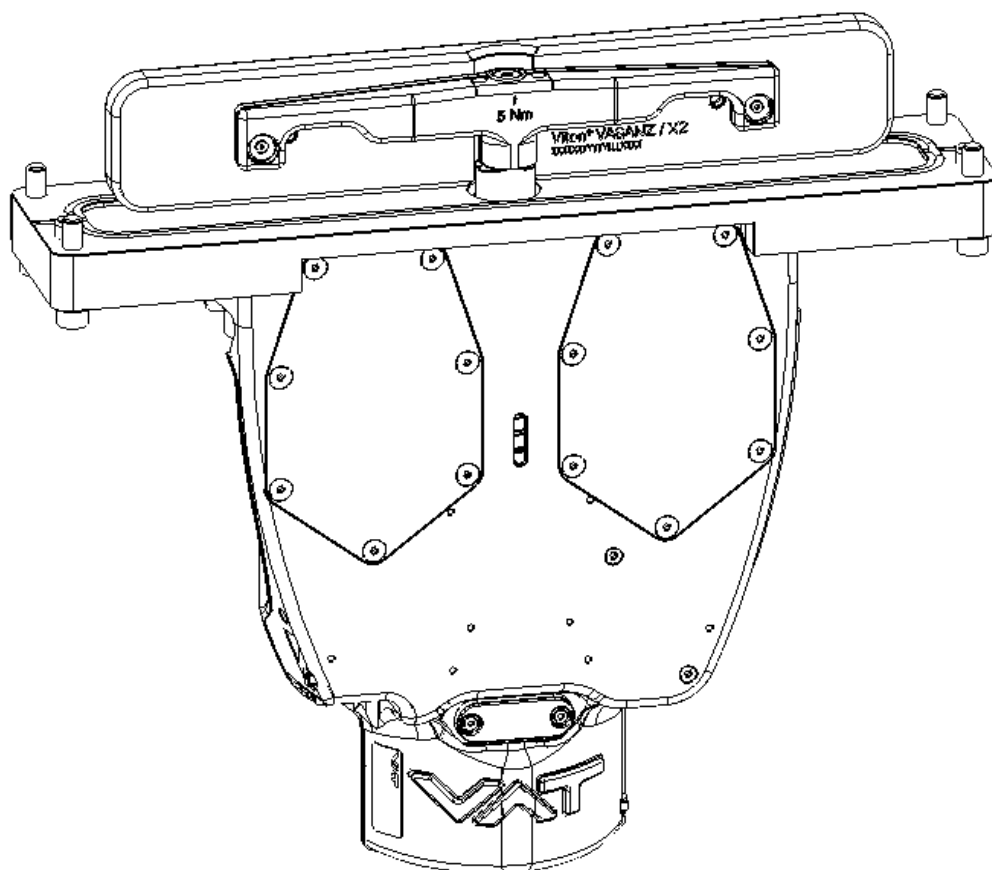

Sample picture

## Imprint

Manufacturer VAT Vakuumventile AG, CH-9469 Haag, Switzerland

Website: [www.vatvalve.com](http://www.vatvalve.com)  
Phone: +41 81 771 61 61  
Fax: +41 81 771 48 30  
Email: [CH@vatvalve.com](mailto:CH@vatvalve.com)

Publisher VAT Vakuumventile AG, CH-9469 Haag, Switzerland

Editor VAT Vakuumventile AG, CH-9469 Haag, Switzerland

Print VAT Vakuumventile AG, CH-9469 Haag, Switzerland

Copyright © VAT Vakuumventile AG 2015

No part of these instructions may be reproduced in any way (photocopies, microfilms or any other reproduction processes) nor may it be manipulated with electronic systems, duplicated or distributed without written permission from VAT. Offenders are liable to pay damages.

The original VAT firmware and updated state of the art versions of the VAT firmware are intended for use with VAT products. The VAT firmware contains a limited, time unlimited user license. The VAT firmware may not be used for purposes other than those intended nor is it permitted to make copies of the VAT firmware. In particular, it is strictly forbidden to give copies of the VAT firmware to other people.

The use of trade names, brand names, trademarks, etc. in these Instructions does not entitle third parties to consider these names to be unprotected and to use them freely. This is in accordance with the meaning of the laws and acts covering brand names and trademarks.

## Contents

<b>1</b>	<b>Description of product.....</b>	<b>4</b>
1.1	Identification of product.....	4
1.2	Use of product.....	4
1.3	Related documents.....	4
1.4	Important information.....	4
1.5	Technical data.....	4
<b>2</b>	<b>Safety .....</b>	<b>5</b>
2.1	Compulsory reading material .....	5
2.2	Danger levels .....	5
2.3	Personnel qualifications.....	6
2.4	Safety labels.....	6
<b>3</b>	<b>Design and Function.....</b>	<b>7</b>
3.1	Design.....	7
3.2	Function .....	8
3.2.1	Series 053.....	8
<b>4</b>	<b>Installation .....</b>	<b>9</b>
4.1	Unpacking .....	9
4.2	Installation into the system.....	10
4.3	Initial operation .....	13
4.4	Compressed air connection .....	14
4.5	Electrical connection.....	15
<b>5</b>	<b>Operation .....</b>	<b>16</b>
5.1	Normal operation.....	16
5.2	Operation under increased temperature.....	16
5.3	Behavior in case of compressed air pressure drop.....	16
5.4	Behavior in case of power failure .....	16
<b>6</b>	<b>Maintenance .....</b>	<b>17</b>
6.1	Maintenance intervals.....	17
6.2	Replacement of gate .....	18
6.3	Replacement of Valve .....	21
<b>7</b>	<b>Repairs .....</b>	<b>23</b>
<b>8</b>	<b>Dismounting and Storage.....</b>	<b>24</b>
8.1	Dismounting .....	24
8.2	Storage .....	25
<b>9</b>	<b>Packaging and Transport .....</b>	<b>26</b>
9.1	Packaging .....	27
9.2	Transport.....	27
<b>10</b>	<b>Disposal .....</b>	<b>28</b>
<b>11</b>	<b>Spare parts .....</b>	<b>29</b>

# 1 Description of product

## 1.1 Identification of product

The fabrication number and order number are fixed on the product directly or by means of an identification plate.



← Part number / Fabrication number

← VAT order number

## 1.2 Use of product

Use product for clean and dry indoor vacuum applications under the conditions indicated in the product data sheet and dimensional drawing. Other applications are only allowed with the written permission of VAT.

## 1.3 Related documents

- Product data sheet
- Dimensional drawing

## 1.4 Important information



This symbol points to a very important statement that requires particular attention.

### Example:



VAT disclaims any liability for damages resulting from inappropriate packaging.

## 1.5 Technical data

See product data sheet and dimensional drawing.

## 2 Safety

### 2.1 Compulsory reading material

Read this chapter prior to performing any work with or on the product. It contains important information that is significant for your own personal safety. This chapter must have been read and understood by all persons who perform any kind of work with or on the product during any stage of its serviceable life.

	NOTICE
	<p><b>Lack of knowledge</b> Failing to read this manual may result in property damage. Firstly, read manual.</p>





These Installation, Operating & Maintenance Instructions are an integral part of a comprehensive documentation belonging to a complete technical system. They must be stored together with the other documentation and accessible for anybody who is authorized to work with the system at any time.

### 2.2 Danger levels



	⚠ DANGER
	<p><b>High risk</b> Indicates a hazardous situation which, if not avoided, will result in death or serious injury.</p>

	⚠ WARNING
	<p><b>Medium risk</b> Indicates a hazardous situation which, if not avoided, could result in death or serious injury.</p>

	⚠ CAUTION
	<p><b>Low risk</b> Indicates a hazardous situation which, if not avoided, may result in minor or moderate injury.</p>

	NOTICE
	<p><b>Command</b> Indicates a hazardous situation which, if not avoided, may result in property damage.</p>

### 2.3 Personnel qualifications

	 <b>WARNING</b>
	<p><b>Unqualified personnel</b>                  Inappropriate handling may cause serious injury or property damage.                  Only qualified personnel are allowed to carry out the described work.</p>

### 2.4 Safety labels

Label	Part No.	Location on valve
	T-9001-156	On actuator

Table 2-1

### 3 Design and Function

### 4 Design

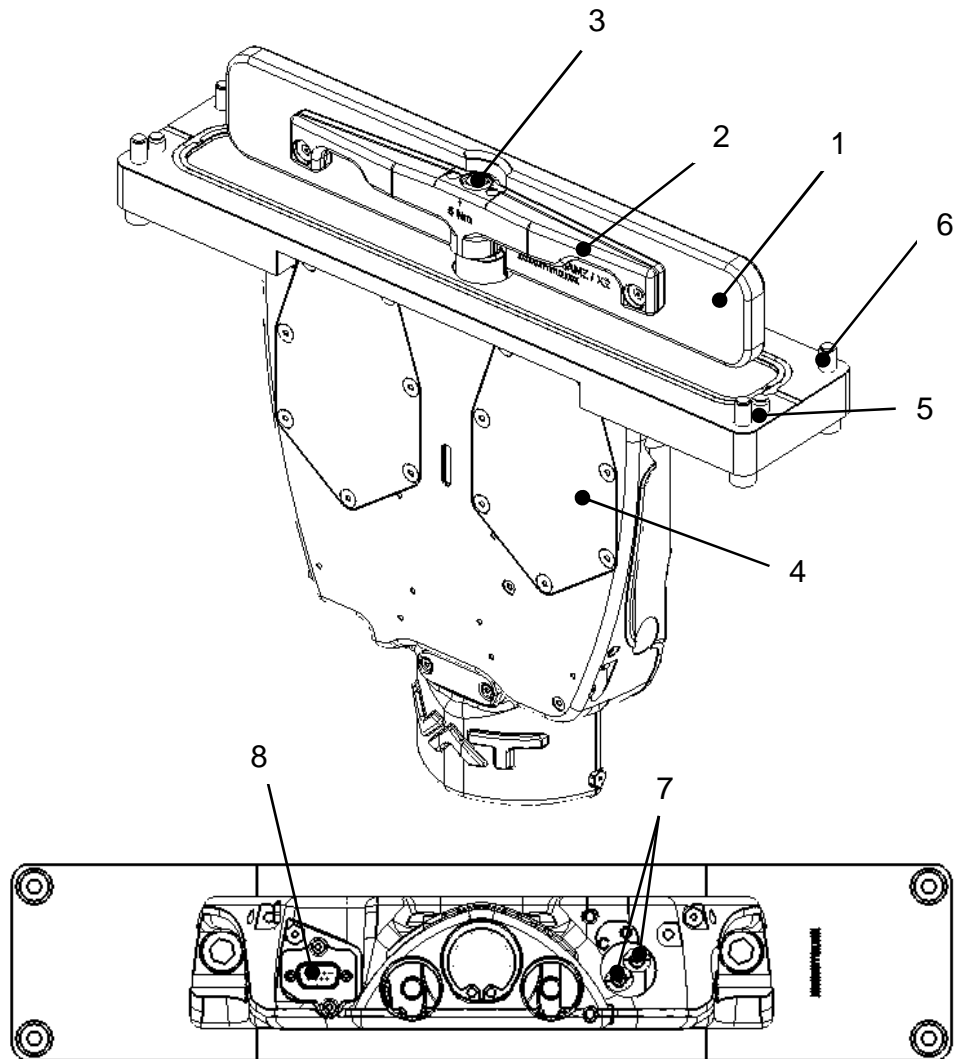

Figure 4-1 Rear side and bottom view

- |                               |                              |
|-------------------------------|------------------------------|
| 1 Gate                        | 5 Alignment pins             |
| 2 Torsion bar                 | 6 Hexagon screws             |
| 3 Gate / Shaft fixation screw | 7 Pneumatic fittings         |
| 4 Actuator                    | 8 D-Sub / Position indicator |

## 4.1 Function

The main actuator performs an L-movement triggered by a pneumatically sequence control. The valve starts in **open position (1)**; see «Figure 4-2». The actuator moves the gate upwards until **position (2)** is reached. The gate is moved towards sealing surface through pneumatic pistons. Movement ends in **closed position (3)**.

### 4.1.1 Series 053

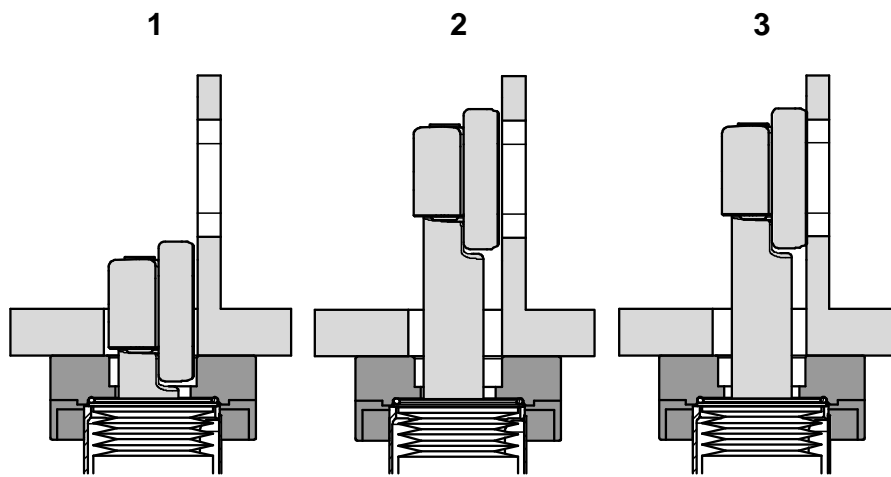

Figure 4-2



## 5 Installation



### **WARNING**

#### **Unqualified personnel**

Inappropriate handling may cause serious injury or property damage.  
Only qualified personnel are allowed to carry out the described work.

### 5.1 Unpacking



- Make sure that the supplied products are in accordance with your order.
- Inspect the quality of the supplied products visually. If it does not meet your requirements, please contact VAT immediately.
- Store the original packaging material. It may be useful if products must be returned to VAT.



### **NOTICE**

#### **Suspended load**

The actuators will be damaged if they touch the ropes or any solid object.  
Use assisting staff when handling the valve by a crane.



- Remove the protective plastic bag only immediately before the valve is mounted to the system.
- Do not remove blue foil on the valve body openings as long as possible in order to protect the valve interior from dust and particles.

## 5.2 Installation into the system

	<b>WARNING</b>
	<p><b>Hazardous components</b>            Parts, loaded springs, air cushions etc. may move or release a movement and cause serious injury.            Do not connect or supply electrical power and compressed air before the product is completely mounted in the system.</p>

Removal of transport flange

	<b>NOTICE</b>
	<p>Before mounting the actuator on the tool, remove the transport flange.  <b>ATTENTION:</b> bellows is not fixed within actuator and can act as a spring when transport flange is removed</p>

Use gate and seat for operation

	<b>NOTICE</b>
	<p><b>ATTENTION:</b>            Do not operate the actuator/valve without the gate and/or valve body!            → Severe bellows damage will occur to the actuator / valve            Do not connect or supply electrical power and compressed air before a gate is mounted to the valve and the product is completely mounted in the system.</p>

	<b>NOTICE</b>
	<p><b>Contamination</b>            Product may get contaminated.            Always wear cleanroom gloves when handling the product.</p>



- Make sure that the sealing surfaces of the valve and the chamber are undamaged.
- Mount valve to a clean system only.
- Make sure that the dimensions and tolerances specified on the dimensional drawing are strictly met under all operation conditions.
- Clamps for installation into the system are not included in the scope of supply. Please refer to system installation description for further information.

### 5.2.1 Type without bonnet flange

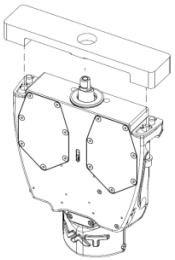
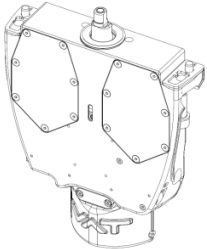
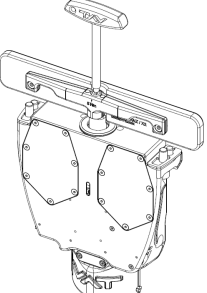
step	Visualization	Description	Needed tools
1		<p><b>Remove the transport flange from actuator</b></p> <p>1 Remove the hexagon screws from the transport flange            → <b>ATTENTION:</b> Bellows is not fixed within the actuator. Remove transport flange carefully to avoid any damage to the bellows</p>	Allen key 10
2		<p><b>Mount the actuator to the transfer module</b></p> <p>1 Insert the actuator carefully to the module interface            → <b>ATTENTION:</b> bellows must be placed carefully in the interface counterpart to avoid a malfunction of the valve</p> <p>2 Tighten the actuator with the hexagon screws with a torque of 50 Nm            → <b>ATTENTION:</b> Do not operate the actuator/valve without the gate and seat mounted! Severe damage to the valve will occur if operated without the mentioned items</p>	Torque wrench
3		<p><b>Installation of the kit gate</b></p> <p>Place the gate onto the shaft and tighten the gate / shaft fixation screw for the gate fixation with a torque of 5 Nm → use torque wrench</p>	Torque wrench
4		<p><b>Connect the valve to power supply</b></p> <p>1 Connect electrical power supply.            2 Connect compressed air supply</p>	

5.2.2 Type with bonnet flange

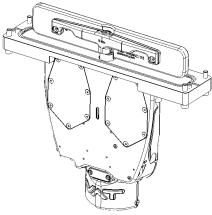
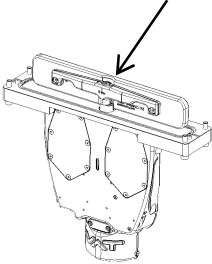
step	Visualization	Description	Needed tools
1		<p><b>Mount the actuator to the transfer module</b></p> <p>1 Insert the actuator carefully to the module interface            → <b>ATTENTION:</b> depending on the customer interface, step 2 (installation of the kit gate) can or must be first step</p> <p>2 Tighten the bonnet flange hexagon screws with a torque of 14.5 Nm            → <b>ATTENTION:</b> Do not operate the actuator/valve without the gate and seat mounted! Severe damage to the valve will occur if operated without the mentioned items</p>	Torque wrench
2		<p><b>Installation of the kit gate</b></p> <p>Place the gate onto the shaft and tighten the gate / shaft fixation screw for the gate fixation with a torque of 5 Nm → use torque wrench</p>	Torque wrench
4		<p><b>Connect the valve to power supply</b></p> <p>1 Connect electrical power supply.            2 Connect compressed air supply</p>	

### 5.3 Initial operation



In order to ensure leak tightness of the valve, it is essential to carry out one cycle on each valve



#### **NOTICE**

**Before carry out one cycle please make sure that the CDA pressure and the electrical connection is done according to the product data sheet and dimensional drawing**



1. Open valve.
2. **Install kit gate (if not mounted)**
3. Close valve.



#### **WARNING:**





**Do not operate the actuator/valve without the gate and seat mounted! Severe damage to the valve will occur if operated without the mentioned items**

## 5.4 Compressed air connection

 <b>WARNING</b>	
	<p><b>Valve in open position</b></p> <p>Risk of injury when compressed air is connected to the valve.</p> <p>Connect compressed air only when:</p> <ul style="list-style-type: none"><li>– valve is installed in the vacuum system</li><li>– moving parts cannot be touched</li></ul>

 <b>WARNING</b>	
	<p><b>Wrong compressed air pressure</b></p> <p>Risk of injury if valve is connected to air supply.</p> <p>Connect valve only with a compressed air pressure according Product data sheet</p>

<b>NOTICE</b>	
	<p><b>Wrong compressed air pressure</b></p> <p>No proper operation if the pressure of the compressed air is less than the pressure indicated in the product data sheet.</p> <p>Only operate the valve with regular compressed air lines.</p>

 Use clean, dry or slightly oiled air only.

 Admissible air pressure range; see product data sheet.

1. Connect compressed air according to the product data sheet and dimensional drawing.

## 5.5 Electrical connection

	<b>NOTICE</b>
	<p><b>Wrong voltage</b> Electrical components may get damaged. Supply electrical components with the correct voltage.</p>

1. Connect solenoid valve according to the product data sheet and dimensional drawing.
2. Connect position indicator according to the product data sheet and dimensional drawing.



Fabrication number: 053...**24**.... without solenoid valve

Fabrication number: 053...**44**.... with solenoid valve

## 6 Operation

	<b>⚠ WARNING</b>
	<b>Unqualified personnel</b> Inappropriate handling may cause serious injury or property damage. Only qualified personnel are allowed to carry out the described work.

	<b>⚠ WARNING</b>
	<b>Movable parts</b> Human body parts may get jammed and severely injured. Do not operate before product is installed completely into the vacuum system.

### 6.1 Normal operation

Valve is opened and closed pneumatically (double acting compressed air cylinder with sequence control).

### 6.2 Operation under increased temperature

Maximum allowed temperature, see product data sheet.

### 6.3 Behavior in case of compressed air pressure drop





See product data sheet.

### 6.4 Behavior in case of power failure

See product data sheet.



## 7 Maintenance





	<p style="text-align: center;"><b>⚠ WARNING</b></p> <p><b>Unqualified personnel</b> Inappropriate handling may cause serious injury or property damage. Only qualified personnel are allowed to carry out the described work.</p>
	<p style="text-align: center;"><b>⚠ WARNING</b></p> <p><b>Hazardous components</b> Parts, loaded springs, air cushions etc. may move or release a movement and cause serious injury. Before starting maintenance: – disconnect compressed air supply – disconnect electrical power supply</p>
	<p style="text-align: center;"><b>⚠ WARNING</b></p> <p><b>Movable parts</b> Human body parts may get jammed and severely injured. Keep human body parts away from movable parts.</p>
	<p style="text-align: center;"><b>NOTICE</b></p> <p><b>Contamination</b> Product may get contaminated. Always wear cleanroom gloves when handling the product.</p>

### 7.1 Maintenance intervals



- Impacts from the process may require more frequent maintenance.
- When the valve has reached the specified cycles → see product data sheet; we recommend to have it serviced by VAT. Please contact your nearest VAT service center to get recommendations and an offer. You will find the addresses on our website [www.vatvalve.com](http://www.vatvalve.com).

## 7.2 Replacement of gate

	<p style="text-align: center;"><b>⚠ WARNING</b></p> <p><b>Unqualified personnel</b>                  Inappropriate handling may cause serious injury or property damage.                  Only qualified personnel are allowed to carry out the described work.</p>
	<p style="text-align: center;"><b>⚠ WARNING</b></p> <p><b>Movable parts</b>                  Human body parts may get jammed and severely injured.                  Keep human body parts away from movable parts.</p>
	<p style="text-align: center;"><b>NOTICE</b></p> <p><b>Wrong tightening torque</b>                  Valve body and screws may get damaged.                  Use tightening torque according to size of the screws.</p>
	<p style="text-align: center;"><b>NOTICE</b></p> <p><b>Contamination</b>                  Product may get contaminated.                  Always wear cleanroom gloves when handling the product.</p>

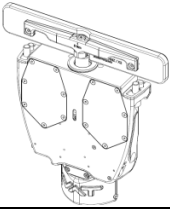
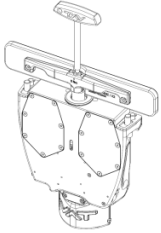
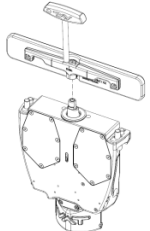
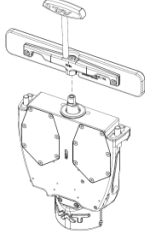
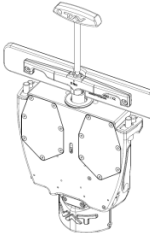
Replacement of vulcanized gate			
step	Visualization	Description	Needed tools
1		<p><b>To change the gate, valve must be in open position</b></p> <p>1 Open the valve 2 Disconnect electrical power supply. 3 Disconnect compressed air supply</p>	CDA connection Electrical connection
2		<p><b>Gate replacement</b></p> <p>1 Loosen the gate / shaft fixation screw with the convenience tool</p>	Convenience tool
		<p>2 Grasp the kit gate by screwing the convenience tool into the M8 thread next to gate / shaft fixation screw</p> <p>3 Remove the gate carefully, if necessary wiggle gently</p>	
3		<p><b>Installation of the kit gate</b></p> <p>1 Grasp the kit gate by screwing the convenience tool into the M8 thread next to gate fixation screw</p>	Convenience tool Torque wrench
		<p>2 Place the gate onto the shaft and tighten the gate / shaft fixation screw for the gate fixation with a torque of 5 Nm → use torque wrench</p>	
4		<p><b>Connect the valve to power supply</b></p> <p>1 Connect electrical power supply. 2 Connect compressed air supply</p>	



Make sure that the gate assembly is in OPEN position

Valve is ready for use.

Replacement of O-ring gate			
step	Visualization	Description	Needed tools
1		1 Perform steps 1 to 2 from section: replacement of vulcanized gate	
2		<b>O-ring change</b> 1 Carefully remove Gate O-ring with an O-ring removal tool from gate	O-ring removal tool 
3		1 Perform steps 3 to 4 from section: replacement of vulcanized gate	





Make sure that the gate assembly is in OPEN position

Valve is ready for use.

### 7.3 Replacement of Actuator

	<b>⚠ WARNING</b>
	<b>Unqualified personnel</b> Inappropriate handling may cause serious injury or property damage. Only qualified personnel are allowed to carry out the described work.

	<b>⚠ WARNING</b>
	<b>Movable parts</b> Human body parts may get jammed and severely injured. Keep human body parts away from movable parts.

	<b>NOTICE</b>
	<b>Wrong tightening torque</b> Valve body and screws may get damaged. Use tightening torque according to size of the screws.

	<b>NOTICE</b>
	<b>Contamination</b> Product may get contaminated. Always wear cleanroom gloves when handling the product.



Actuator replacement can be done from the bottom of the tool.

Replacement of actuator			
step	Visualization	Description	Needed tools
1		<p><b>Before actuator can be removed carry out following steps</b></p> <p>1 remove the kit gate by performing step 1 to 2 from section: replacement of vulcanized gate</p>	
2		<p><b>Removing of the actuator</b></p> <p>1 Loose the two actuator fixing screws</p> <p>2 Remove the actuator from transfer module</p> <p>→ <b>ATTENTION: Bellows is not fixed within the actuator. Remove actuator carefully to avoid any damage to the bellows</b></p>	Allen key 10
		3 Mount transport flange on actuator to protect the bellows	Transport flange Allen key 10
Installation of actuator			
1		<p><b>To install the new valve following steps have to be carried out</b></p> <p>1 Perform the steps from section: 5.2.1Type without bonnet flange</p>	



Make sure that the gate assembly is in OPEN position





Valve is ready for use.

## 8 Repairs

Repairs may only be carried out by the VAT service staff. In exceptional cases, the customer is allowed to carry out the repairs, but only with the prior consent of VAT.

Please contact one of our service centers. You will find the addresses on our website [www.vatvalve.com](http://www.vatvalve.com).

## 9 Dismounting and Storage

	<p style="text-align: center;"><b>⚠ WARNING</b></p> <p><b>Unqualified personnel</b>                  Inappropriate handling may cause serious injury or property damage.                  Only qualified personnel are allowed to carry out the described work.</p>
	<p style="text-align: center;"><b>⚠ WARNING</b></p> <p><b>Hazardous components</b>                  Parts, loaded springs, air cushions etc. may move or release a movement and cause serious injury.                  Before dismounting the product:                  – disconnect compressed air supply                  – disconnect electrical power supply</p>
	<p style="text-align: center;"><b>⚠ WARNING</b></p> <p><b>Movable parts</b>                  Human body parts may get jammed and severely injured.                  Keep human body parts away from movable parts.</p>
	<p style="text-align: center;"><b>NOTICE</b></p> <p><b>Contamination</b>                  Product may get contaminated.                  Always wear cleanroom gloves when handling the product.</p>

### 9.1 Dismounting

1. Open valve.

For dismounting the valve follow the instruction of chapter «5 Installation», however in reverse order.



Observe safety instruction of chapter «5 Installation».



## 9.2 Storage

<b>NOTICE</b>	
	<p><b>Wrong storage</b></p> <p>Inappropriate temperatures and humidity may cause damage to the product.</p> <p>Valve must be stored at:</p> <ul style="list-style-type: none"><li>– relative humidity between 10% and 70%</li><li>– temperature between +10 °C and +50 °C</li><li>– non-condensing environment</li></ul>

<b>NOTICE</b>	
	<p><b>Inappropriate packaging</b></p> <p>Product may get damaged if inappropriate packaging material is used.</p> <p>Always use the original packaging material and handle product with care.</p>

1. Clean / decontaminate valve.
2. Cover all valve openings with a protective foil.
3. Pack valve appropriately, by using the original packaging material.

## 10 Packaging and Transport

	<p style="text-align: center;"><b>⚠ WARNING</b></p> <p><b>Unqualified personnel</b> Inappropriate handling may cause serious injury or property damage. Only qualified personnel are allowed to carry out the described work.</p>
	<p style="text-align: center;"><b>⚠ WARNING</b></p> <p><b>Harmful substances</b> Risk of injury in case of contact with harmful substances. Remove harmful substances (e. g. toxic, caustic or microbiological ones) from valve before you return the valve to VAT.</p>
	<p style="text-align: center;"><b>NOTICE</b></p> <p><b>Inappropriate packaging</b> Product may get damaged if inappropriate packaging material is used. Always use the original packaging material and handle product with care.</p>



- When returning products to VAT, please fill out the VAT form «Declaration of Chemical Contamination» and send it to VAT in advance. The form can be downloaded from our website [www.vatvalve.com](http://www.vatvalve.com).
- If products are radioactively contaminated, the VAT form «Contamination and Radiation Report» must be filled out. Please contact VAT in advance.
- If products are sent to VAT in contaminated condition, VAT will carry out the decontamination procedure at the customer's expense.

## 10.1 Packaging

1. Cover all valve openings with a protective foil.
2. Pack valve appropriately, by using the original packaging material.



VAT disclaims any liability for damages resulting from inappropriate packaging.

## 10.2 Transport



### **NOTICE**

#### **Inappropriate packaging**

Product may get damaged if inappropriate packaging material is used.  
Always use the original packaging material and handle product with care.



VAT disclaims any liability for damages resulting from inappropriate packaging.

## 11 Disposal

	<b>⚠ WARNING</b>	
	<b>Harmful substances</b>	
	Environmental pollution. Discard products and parts according to the local regulations.	

## 12 Spare parts

	NOTICE
	<p><b>Non-original spare parts</b></p> <p>Non-original spare parts may cause damage to the product. Use original spare parts from VAT only.</p>



- Please specify the fabrication number of the product when you place an order for spare parts; see chapter «1.1 Identification of product». This is to ensure that the appropriate spare parts are supplied.
- VAT makes a difference between spare parts that may be replaced by the customer and those that need to be replaced by the VAT service staff.
- «Table 12-1» only contains spare parts that may be replaced by the customer. If you need any other spare parts, please contact one of our service centers. You will find the addresses on our website [www.vatvalve.com](http://www.vatvalve.com).

Description	Part No.	Quantity per valve	Maintenance procedure see chapter
Convenience tool 100x160	239582	1	«7.2 Replacement of gate»
Convenience tool 100x275	426599	1	«7.2 Replacement of gate»
Kit gate	on request	1	«7.2 Replacement of gate»
Spare actuator	on request	1	«7.3 Replacement of »
O-ring removal tool	234859	1	«7.2 Replacement of gate»

Table 12-1