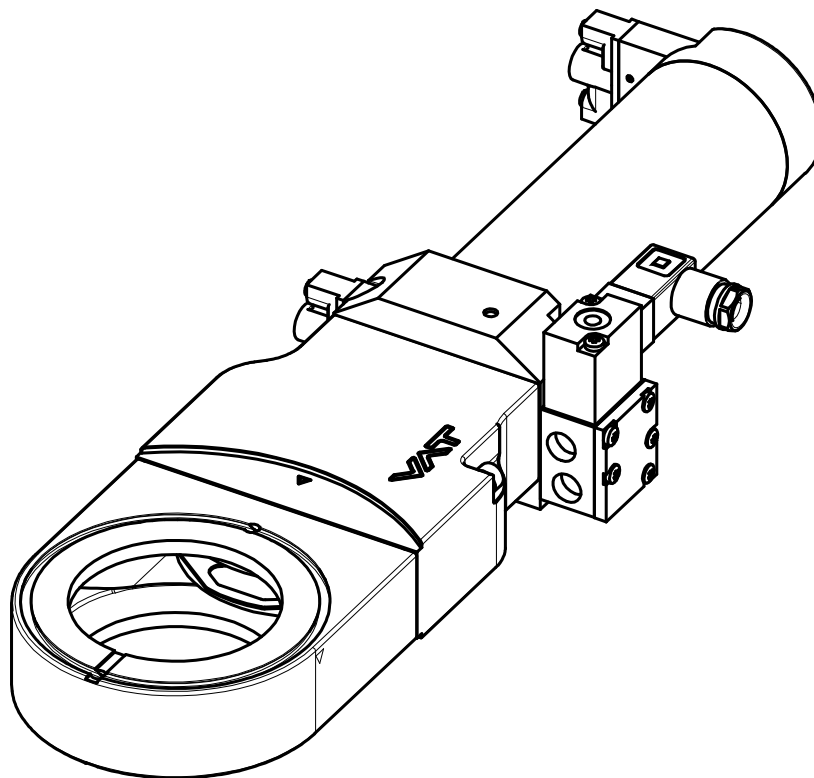


Insertable gate valve with double acting pneumatic actuator

Series 081
DN 63 – 100 mm (I. D. 2½" – 4")

This manual is valid for the following product ordering numbers:
081 .. - -



Sample picture

Imprint

Manufacturer VAT Vakuumventile AG, CH-9469 Haag, Switzerland

Website: www.vatvalve.com
Phone: +41 81 771 61 61
Fax: +41 81 771 48 30
Email: CH@vatvalve.com

Publisher VAT Vakuumventile AG, CH-9469 Haag, Switzerland

Editor VAT Vakuumventile AG, CH-9469 Haag, Switzerland

Print VAT Vakuumventile AG, CH-9469 Haag, Switzerland

Copyright © VAT Vakuumventile AG 2019

No part of these instructions may be reproduced in any way (photocopies, microfilms or any other reproduction processes) nor may it be manipulated with electronic systems, duplicated or distributed without written permission from VAT. Offenders are liable to pay damages.

The original VAT firmware and updated state of the art versions of the VAT firmware are intended for use with VAT products. The VAT firmware contains a limited, time unlimited user license. The VAT firmware may not be used for purposes other than those intended nor is it permitted to make copies of the VAT firmware. In particular, it is strictly forbidden to give copies of the VAT firmware to other people.

The use of trade names, brand names, trademarks, etc. in these Instructions does not entitle third parties to consider these names to be unprotected and to use them freely. This is in accordance with the meaning of the laws and acts covering brand names and trademarks.

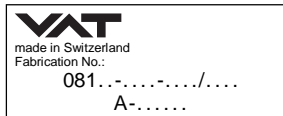
Contents

1	Description of product	4
1.1	Identification of product.....	4
1.2	Use of product.....	4
1.3	Related documents.....	4
1.4	Important information.....	4
1.5	Technical data.....	4
2	Safety	5
2.1	Compulsory reading material.....	5
2.2	Danger levels.....	5
2.3	Personnel qualifications.....	6
2.4	Safety labels.....	6
3	Design and Function	7
3.1	Design.....	7
3.2	Function.....	7
4	Installation	8
4.1	Unpacking.....	8
4.2	Installation into the system.....	8
4.3	Compressed air connection.....	10
4.4	Electrical connection.....	10
5	Operation	11
5.1	Normal operation.....	11
5.2	Operation under increased temperature.....	11
5.3	Behavior in case of compressed air pressure drop.....	11
5.4	Behavior in case of power failure.....	11
5.4.1	Manual emergency operation.....	12
5.5	Trouble shooting.....	13
6	Maintenance	14
6.1	Maintenance intervals.....	14
6.2	Tightening torque specifications.....	15
6.3	Required tools.....	15
6.4	Replacement of gate seal and bonnet seal.....	15
7	Repairs	19
8	Dismounting and Storage	20
8.1	Dismounting.....	21
8.2	Storage.....	21
9	Packaging and Transport	22
9.1	Packaging.....	23
9.2	Transport.....	23
10	Disposal	24
11	Spare parts	25

1 Description of product

1.1 Identification of product

The fabrication number and order number are fixed on the product directly or by means of an identification plate.



← Fabrication number
← Order number

1.2 Use of product

Use product for clean and dry vacuum applications only. Other applications are only allowed with the written permission of VAT.

1.3 Related documents

- Product data sheet
- Dimensional drawing

1.4 Important information



This symbol points to a very important statement that requires particular attention.

Example:



VAT disclaims any liability for damages resulting from inappropriate packaging.


1.5 Technical data

See product data sheet and dimensional drawing.

2 Safety

2.1 Compulsory reading material


Read this chapter prior to performing any work with or on the product. It contains important information that is significant for your own personal safety. This chapter must have been read and understood by all persons who perform any kind of work with or on the product during any stage of its serviceable life.


	NOTICE
	<p>Lack of knowledge Failing to read this manual may result in property damage. Firstly, read manual.</p>





These Installation, Operating & Maintenance Instructions are an integral part of a comprehensive documentation belonging to a complete technical system. They must be stored together with the other documentation and accessible for anybody who is authorized to work with the system at any time.

2.2 Danger levels

	⚠ DANGER
	<p>High risk Indicates a hazardous situation which, if not avoided, will result in death or serious injury.</p>

	⚠ WARNING
	<p>Medium risk Indicates a hazardous situation which, if not avoided, could result in death or serious injury.</p>

	⚠ CAUTION
	<p>Low risk Indicates a hazardous situation which, if not avoided, may result in minor or moderate injury.</p>

	NOTICE
	<p>Command Indicates a hazardous situation which, if not avoided, may result in property damage.</p>

2.3 Personnel qualifications

	WARNING
	<p>Unqualified personnel Inappropriate handling may cause serious injury or property damage. Only qualified personnel are allowed to carry out the described work.</p>

2.4 Safety labels

Label	Part No.	Location on valve
	T-9001-155	Protective cover
	N-6289-351	On the actuator

Table 2-1

3 Design and Function

3.1 Design

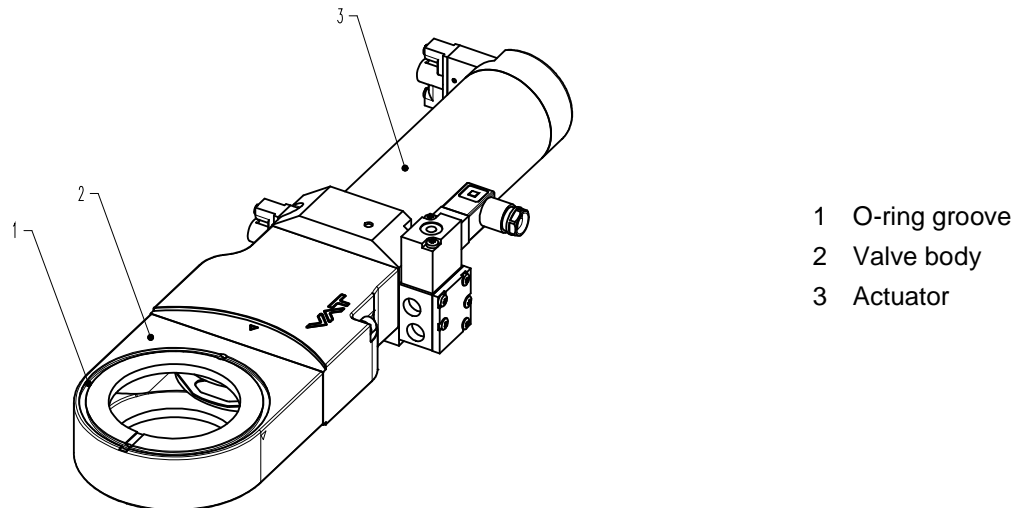


Figure 3-1

3.2 Function

The valve features the VATLOCK sealing technology. This means, the valve is mechanically locked in the closed position. In the open position, the mechanism is not locked. Leaf springs hold gate and counter plate against the carriage with the ball retainers. The ball pairs are in the detents. For closing, the mechanism is moved forward into the closing position. The locking starts after the leaf spring stop touches the body. The ball retainers move the ball pairs out of the detents. Gate and counter-plate are spread apart. The gate seal is pressed against the sealing surface without scuffing. The arrangement of the ball pairs ensures an increase of the sealing force with vacuum on the seat side of the valve gate. During opening the movements proceed in the reverse order; see «Figure 3-2».

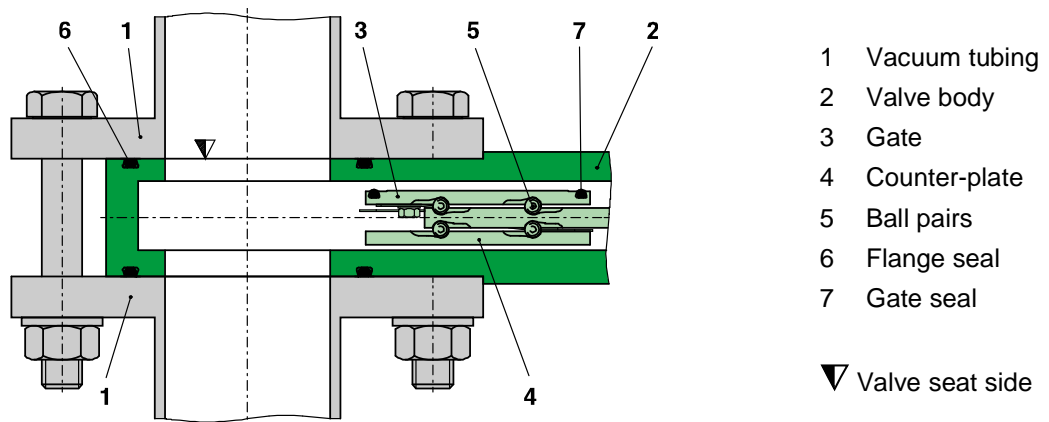


Figure 3-2

4 Installation

	⚠ WARNING
	<p>Unqualified personnel Inappropriate handling may cause serious injury or property damage. Only qualified personnel are allowed to carry out the described work.</p>




4.1 Unpacking

- | | |
|--|--|
| | <ul style="list-style-type: none"> • Make sure that the supplied products are in accordance with your order. • Inspect the quality of the supplied products visually. If it does not meet your requirements, please contact VAT immediately. • Store the original packaging material. It may be useful if products must be returned to VAT. |
|--|--|

4.2 Installation into the system

	⚠ WARNING
	<p>Movable parts Human body parts may get jammed and severely injured. Do not connect or supply electrical power and compressed air before the product is completely mounted in the system.</p>

	NOTICE
	<p>Contamination Product may get contaminated. Always wear cleanroom gloves when handling the product.</p>

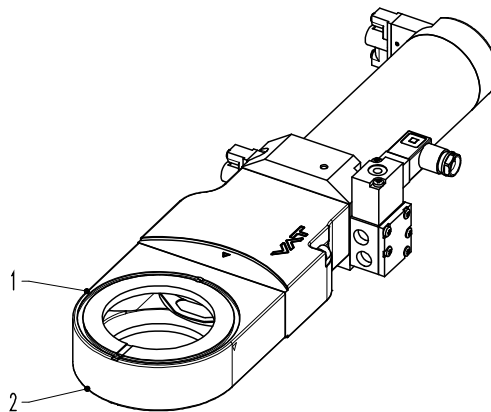
	<p style="text-align: right;">NOTICE</p> <p>Inappropriate tools Sealing surfaces may get damaged. Do not use sharp-edged tools.</p>
	<p style="text-align: right;">NOTICE</p> <p>Wrong tightening torque Valve body and screws may get damaged. Use tightening torque according the size of the screws.</p>
	<p style="text-align: right;">NOTICE</p> <p>Too long screws Valve body may get deformed and / or malfunctions may occur. Use only screws recommended by VAT.</p>

1. Remove protective covers from body flanges.
2. Clean sealing surfaces and seals of both flanges;
see (1) and (2) according to «Figure 4-1».



The valve seat side is marked with the symbol «∇» on flange «A».

3. Lift the valve to the mounting position.



- 1 Flange A
- 2 Flange B

Figure 4-1

4.3 Compressed air connection

	WARNING
	<p>Valve in open position Risk of injury when compressed air is connected to the valve. Connect compressed air only when:</p> <ul style="list-style-type: none"> – valve is installed in the vacuum system – moving parts cannot be touched



Use clean, dry or slightly oiled air only.



Admissible air pressure range, see product data sheet.

1. Connect compressed air according to the product data sheet and dimensional drawing.




4.4 Electrical connection

	DANGER
	<p>Electric shock Parts being under voltage will result in serious injury or death. Do not touch parts being under voltage.</p>

	NOTICE
	<p>Wrong voltage Electrical components may get damaged. Supply electrical components with the correct voltage.</p>

1. Connect solenoid valve according to the product data sheet and dimensional drawing.
2. Connect position indicator according to the product data sheet and dimensional drawing.
3. Connect heater (option) according to the product data sheet and dimensional drawing.

5 Operation

	<p style="text-align: center;">⚠ WARNING</p> <p>Unqualified personnel Inappropriate handling may cause serious injury or property damage. Only qualified personnel are allowed to carry out the described work.</p>
	<p style="text-align: center;">⚠ WARNING</p> <p>Movable parts Human body parts may get jammed and severely injured. Do not operate before product is installed completely into the vacuum system.</p>
	<p style="text-align: center;">⚠ WARNING</p> <p>Hot surfaces Risk of burning when touching hot surfaces. Do not touch hot surfaces.</p>

5.1 Normal operation

Valve is opened and closed pneumatically.

5.2 Operation under increased temperature

Maximum allowed temperature, see product data sheet.


5.3 Behavior in case of compressed air pressure drop


See product data sheet.

5.4 Behavior in case of power failure

See product data sheet.

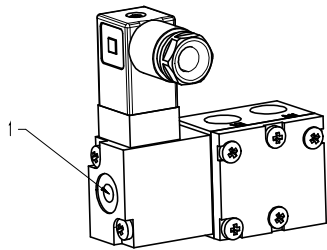
5.4.1 Manual emergency operation

	⚠ WARNING
<p>Movable parts Human body parts may get jammed and severely injured. Keep human body parts away from movable parts.</p>	

 Only valid for the ordering number 081...**34/44** (with solenoid valve)

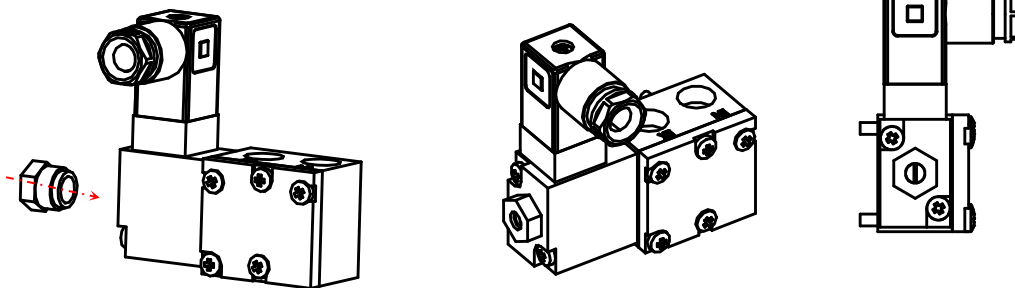
In case of a power failure, the valve can be actuated manually if compressed air is available.

Standard solenoid valve



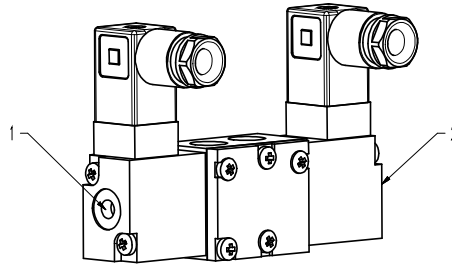
Press push-button (1): valve opens
 Release push-button (1): valve closes

Solenoid valve with lockable emergency operation (option)



Push and rotate in lockable: valve opens
 Push and rotate unlockable: valve closes

Solenoid valve for impulse actuation (option)



Press push-button (1): valve opens
Press push-button (2): valve closes





5.5 Trouble shooting

Failure	Check	Action	See
Valve does not close / open	Air pressure	Connect compressed air	«4.3 Compressed air connection»
	Operating pressure	Adjust operating pressure	Product data sheet
	Voltage at solenoid valve	Connect voltage	«4.4 Electrical connection»
Leak at gate	Gate seal all right?	Replace gate O-ring	«6.4 Replacement of gate seal and bonnet seal»
	Gate damaged or contaminated?	Replace valve gate	«6.4 Replacement of gate seal and bonnet seal»
	Operating pressure	Adjust operating pressure	Product data sheet
Leak at body	Bonnet seal and sealing surface all right?	Clean sealing surface, if necessary, replace bonnet seal	«6.4 Replacement of gate seal and bonnet seal»

Table 5-1

If you need any further information, please contact one of our service centers. You will find the addresses on our website www.vatvalve.com.

6 Maintenance

	<p style="text-align: center;">⚠ WARNING</p> <p>Unqualified personnel Inappropriate handling may cause serious injury or property damage. Only qualified personnel are allowed to carry out the described work.</p>
	<p style="text-align: center;">⚠ WARNING</p> <p>Hazardous components Human body parts may get jammed and severely injured. Before starting maintenance: – disconnect compressed air supply – disconnect electrical power supply</p>
	<p style="text-align: center;">⚠ WARNING</p> <p>Movable parts Human body parts may get jammed and severely injured. Keep human body parts away from movable parts.</p>
	<p style="text-align: center;">⚠ WARNING</p> <p>Hot surfaces Risk of burning when touching hot surfaces. Touch hot surfaces only if the valve has cooled down.</p>

6.1 Maintenance intervals

Under clean operating conditions the valve does not require any maintenance during the specified cycles; see product data sheet. After these cycles, VAT recommends replacing the mechanism unit; see chapter «6.4 Replacement of gate seal and bonnet seal».

For more information or a general overhaul please contact one of our service centers. You will find the addresses on our website www.vatvalve.com.

6.2 Tightening torque specifications

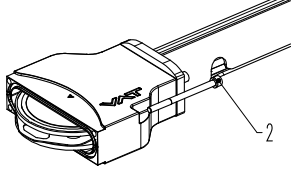
Item-No.	Description	Tightening torque [Nm] DN 63 – 100	
2	Bonnet screw	3.5	

Table 6-1

6.3 Required tools

- Torque wrench
- Cleanroom wiper soaked with alcohol (2% methyl ethyl ketone)
- O-Ring removal tool; see «Table 11-1» on page 25

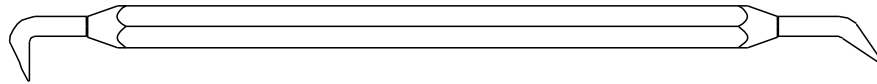




Figure 6-1

6.4 Replacement of gate seal and bonnet seal

	⚠ WARNING
	<p>Loaded spring steel sheet Human body parts may get jammed and severely injured. Do not put human body parts between valve gate and spring steel sheet.</p>
	NOTICE
	<p>Contamination Product may get contaminated. Always wear cleanroom gloves when handling the product.</p>

	NOTICE
	<p>Inappropriate tools Sealing surfaces may get damaged. Do not use sharp-edged tools.</p>

The numbers in brackets () refer to «Figure 6-4» on page 18.

1. Vent chambers on either side to atmospheric pressure.
2. Open valve.
3. Disconnect compressed air supply.
4. Disconnect electrical power supply.
5. Loosen both screws (2).



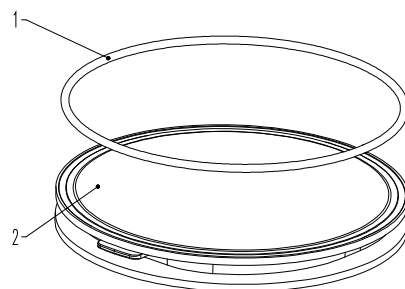
Make sure to maintain upper valve body (5) in its position while loosening the screws!

6. Lift upper valve body (5) carefully from lower part of body (1) without touching the body wall and put it on a clean place (seat side symbol «∇» on top).
7. Apply compressed air (air pressure approx. 1 bar) and move mechanism slowly out of upper part of body (5).



Provide sufficient free space in order to prevent the mechanism from touching any objects.

8. Disconnect compressed air.
9. Remove gate seal (1) from groove; see «Figure 6-2»; use O-ring removal tool.



- 1 Gate seal
- 2 Valve gate

Figure 6-2

10. Check and clean sealing surface of valve seat; use cleanroom wiper.
11. Install new gate seal (1); see «Figure 6-2».



Press O-ring uniformly in crosswise order (diagonal) into groove.

12. Remove bonnet seal (3) from groove; use O-ring removal tool.
13. Check and clean sealing surface of bonnet seat; use cleanroom wiper.
14. Install new bonnet seal (3).



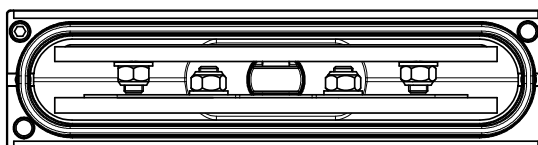
- Press O-ring into groove on one short side.
- Distribute seal uniformly over long sides to opposite short side and press it fully into groove.



Make sure to have gate seal (1); see «Figure 6-2» on page 16; on seat side «∇».



Align mechanism with opening of upper part of body.



15. Apply compressed air (air pressure approx. 1 bar) and move mechanism slowly into upper valve body (5).



Provide sufficient free space in order to prevent the mechanism from touching any objects.

16. Disconnect compressed air from valve.

17. Lift upper valve body (5) carefully back into the lower valve body (1) without touching the body wall.



The tips of the triangles «∇» of both body parts must face each other; see «Figure 6-3».

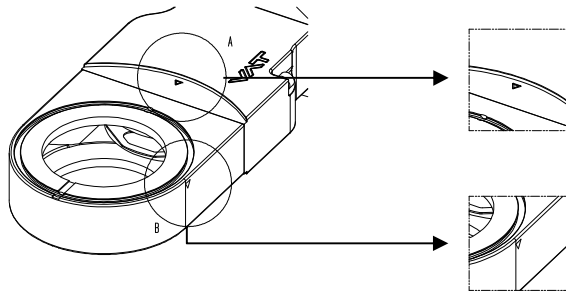


Figure 6-3

18. Tighten the screws (2); with the appropriate torque specified in chapter «6.2 Tightening torque specifications» on page 15.
19. Connect electrical power supply.
20. Connect compressed air supply.
21. Close the valve.

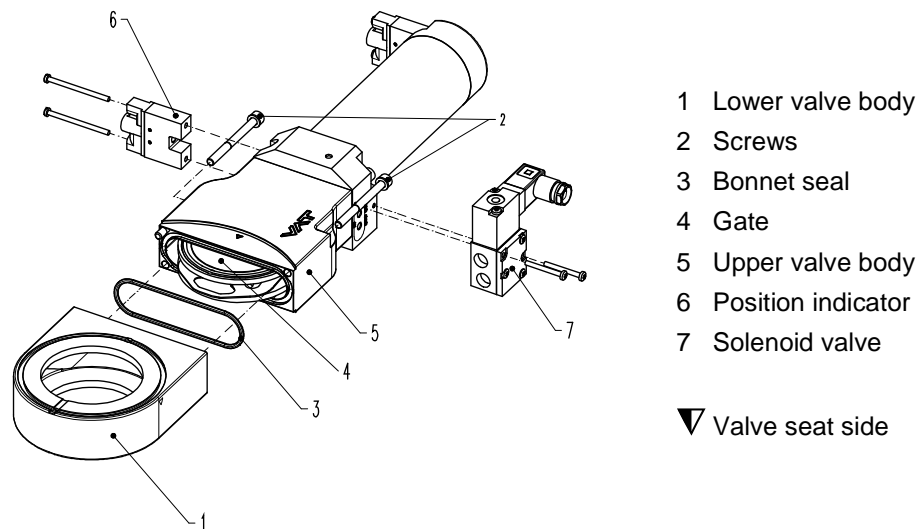


Figure 6-4






Valve is ready for use.

7 Repairs


Repairs may only be carried out by the VAT service staff. In exceptional cases, the customer is allowed to carry out the repairs, but only with the prior consent of VAT.

Please contact one of our service centers. You will find the addresses on our website www.vatvalve.com.

8 Dismounting and Storage


	<p style="text-align: center;">⚠ WARNING</p> <p>Unqualified personnel Inappropriate handling may cause serious injury or property damage. Only qualified personnel are allowed to carry out the described work.</p>
	<p style="text-align: center;">⚠ WARNING</p> <p>Hazardous components Human body parts may get jammed and severely injured. Before dismounting the product</p> <ul style="list-style-type: none"> – disconnect compressed air supply – disconnect electrical power supply
	<p style="text-align: center;">⚠ WARNING</p> <p>Movable parts Human body parts may get jammed and severely injured. Keep human body parts away from movable parts.</p>
	<p style="text-align: center;">⚠ WARNING</p> <p>Hot surfaces Risk of burning when touching hot surfaces. Touch hot surfaces only if the valve has cooled down.</p>
	<p style="text-align: center;">NOTICE</p> <p>Contamination Product may get contaminated. Always wear cleanroom gloves when handling the product.</p>


8.1 Dismounting

	NOTICE
	<p>Valve in open position Valve mechanism may get damaged if valve is in open position. Close valve before dismounting the valve from the system.</p>

1. Close valve.
2. Carry out the steps according to chapter «4 Installation» in reverse order.
Pay attention to the safety instructions!

8.2 Storage

	NOTICE
	<p>Wrong storage Inappropriate temperatures and humidity may cause damage to the product. Valve must be stored at: – relative humidity between 10% and 70% – temperature between +10 °C and +50 °C – non-condensing environment</p>

	NOTICE
	<p>Inappropriate packaging Product may get damaged if inappropriate packaging material is used. Always use the original packaging material and handle product with care.</p>

1. Clean / decontaminate valve.
2. Cover all valve openings with a protective foil.
3. Pack valve appropriately, by using the original packaging material.

9 Packaging and Transport

	⚠ WARNING
	<p>Unqualified personnel</p> <p>Inappropriate handling may cause serious injury or property damage. Only qualified personnel are allowed to carry out the described work.</p>


	⚠ WARNING
	<p>Harmful substances</p> <p>Risk of injury in case of contact with harmful substances. Remove harmful substances (e. g. toxic, caustic or microbiological ones) from valve before you return the valve to VAT.</p>

	NOTICE
	<p>Inappropriate packaging</p> <p>Product may get damaged if inappropriate packaging material is used. Always use the original packaging material and handle product with care.</p>



- When returning products to VAT, please fill out the VAT form «Declaration of Chemical Contamination» and send it to VAT in advance. The form can be downloaded from our website www.vatvalve.com.
- If products are radioactively contaminated, the VAT form «Contamination and Radiation Report» must be filled out. Please contact VAT in advance.
- If products are sent to VAT in contaminated condition, VAT will carry out the decontamination procedure at the customer's expense.

9.1 Packaging


NOTICE	
	<p>Valve in open position Valve mechanism may get damaged if valve is in open position. Make sure that the valve is closed.</p>

1. Cover all valve openings with a protective foil.
2. Pack valve appropriately, by using the original packaging material.



VAT disclaims any liability for damages resulting from inappropriate packaging.


9.2 Transport

NOTICE	
	<p>Inappropriate packaging Product may get damaged if inappropriate packaging material is used. Always use the original packaging material and handle product with care.</p>




VAT disclaims any liability for damages resulting from inappropriate packaging.

10 Disposal

	⚠ WARNING	
	Harmful substances Environmental pollution. Discard products and parts according to the local regulations.	

11 Spare parts

NOTICE	
	<p>Non-original spare parts Non-original spare parts may cause damage to the product. Use original spare parts from VAT only.</p>



- Please specify the fabrication number of the product when you place an order for spare parts; see chapter «1.1 Identification of product». This is to ensure that the appropriate spare parts are supplied.
- VAT makes a difference between spare parts that may be replaced by the customer and those that need to be replaced by the VAT service staff.
- «Table 11-1» only contains spare parts that may be replaced by the customer. If you need any other spare parts, please contact one of our service centers. You will find the addresses on our website www.vatvalve.com.

Description	Part No.	Quantity per valve	Maintenance procedure see chapter
Replacement kit	on request	1	«6.4 Replacement of gate seal and bonnet seal»
Gate O-ring	on request	1	«6.4 Replacement of gate seal and bonnet seal»
Bonnet flange O-ring	on request	1	«6.4 Replacement of gate seal and bonnet seal»
O-ring removal tool	234859	1	«6.4 Replacement of gate seal and bonnet seal»
VAT vacuum grease	on request	1	«6.4 Replacement of gate seal and bonnet seal»

Table 11-1