

D-side

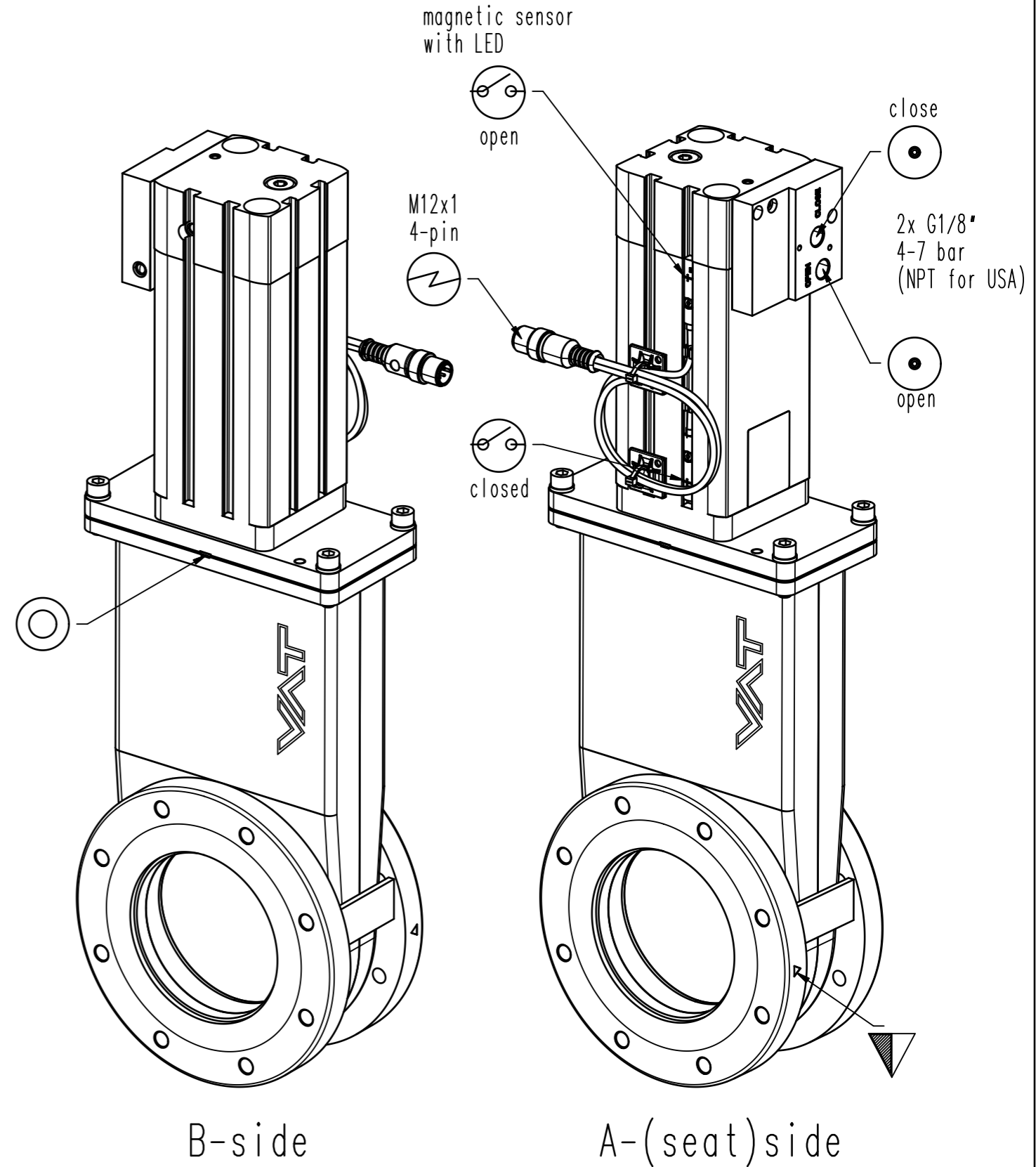
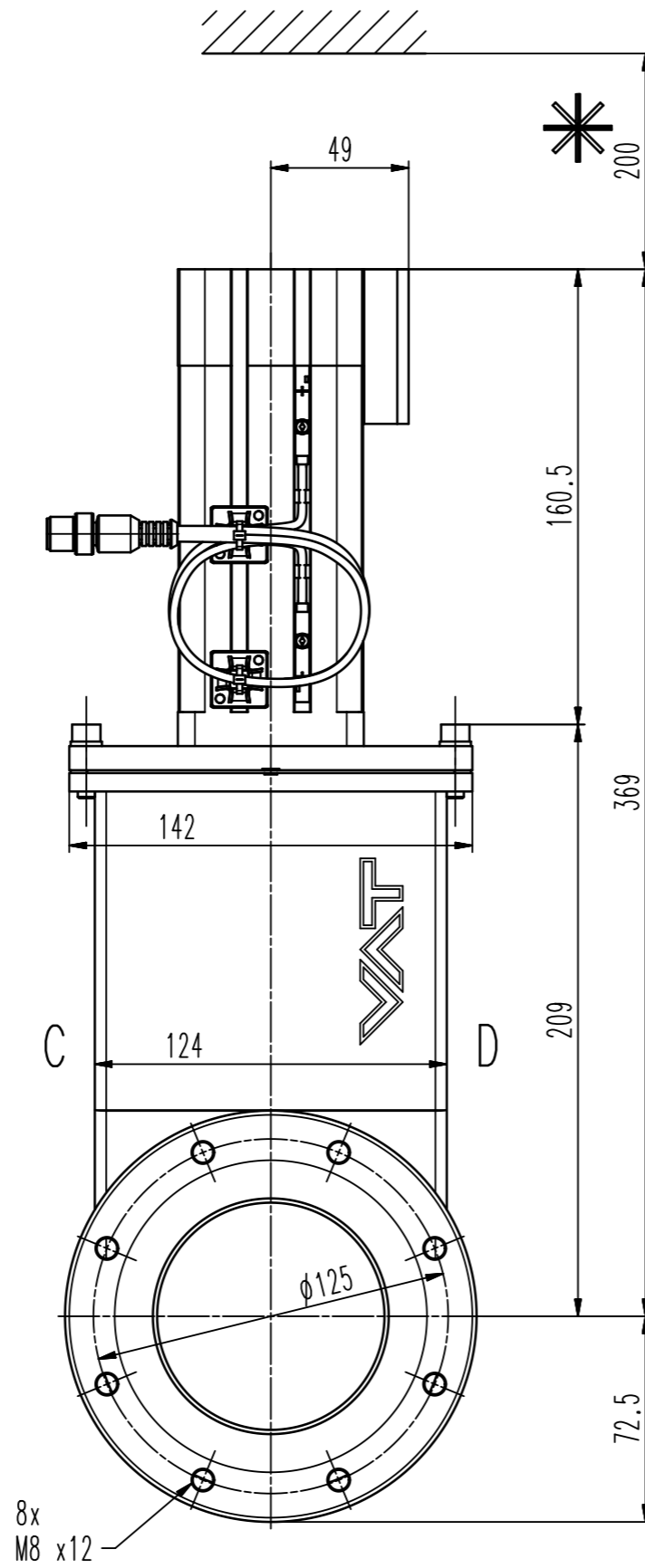

B-side

A-(seat)side

- ▼ Seat side
- ⊙ Comp. air connection
- ⊙ Electrical connection
- ⊙ Leak detection port
- ⊙ Mech. pos. indication
- ⊙ Position indicator
- ⊙ Required for dismantling
- ⊙ Emergency actuation
- ⊙ For attachment
- ⊙ Bake-out area
- ⊙ Differential pumping port

HV gate valve



VAT Vakuumventile AG  
CH-9469 Haag, Switzerland  
Tel ++41 81 7716161 Fax ++41 81 7714830

Rev.-Date: 15.06.21  
Visa: MAEM

Series	091		Ordering No.	09138-PE24-0003	
Projection E	DN	Flange			
	80	ISO-F			
Dimensional Drawing	1095391		Rev.	A	