

HV Gate Valve with maual actuator

This manual is valid for the valve ordering number(s):

09136-PE01-....

09138-PE01-....

09140-PE01-....

09144-PE01-....

The fabrication number is indicated on each product as per the label below (or similar):

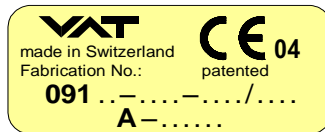

← Fabrication number



Explanation of symbols:



Read declaration carefully before you start any other action!



Keep body parts and objects away from the valve opening!



Attention!



Hot surfaces; do not touch!



Product is in conformity with EC guidelines, if applicable!



Loaded springs and/or air cushions are potential hazards!



Disconnect electrical power and compressed air lines. Do not touch parts under voltage!



Wear gloves!



Read these «**Installation, Operating & Maintenance Instructions**» and the enclosed «**General Safety Instructions**» carefully before you start any other action!



Imprint:

Manufacturer VAT Vakuumventile AG, CH-9469 Haag, Switzerland

Website
www.vatvalve.com

Phone
+41 81 771 61 61

Fax
+41 81 771 48 30

Email
CH@vatvalve.com

Publisher VAT Vakuumventile AG, CH-9469 Haag, Switzerland

Editor VAT Vakuumventile AG, CH-9469 Haag, Switzerland

Print VAT Vakuumventile AG, CH-9469 Haag, Switzerland

Copyright © VAT Vakuumventile AG 2008

No part of these Instructions may be reproduced in any way (photocopies, microfilms or any other reproduction processes) nor may it be manipulated with electronic systems, duplicated or distributed without written permission from VAT. Offenders are liable to pay damages.

The original VAT firmware and updated state of the art versions of the VAT firmware are intended for use with VAT products. The VAT firmware contains a limited, time unlimited user license. The VAT firmware may not be used for purposes other than those intended nor is it permitted to make copies of the VAT firmware. In particular, it is strictly forbidden to give copies of the VAT firmware to other people.

The use of trade names, brand names, trademarks, etc. in these Instructions does not entitle third parties to consider these names to be unprotected and to use them freely. This is in accordance with the meaning of the laws and acts covering brand names and trademarks.



Contents:

| | | |
|-------|---|----|
| 1 | Use of product..... | 4 |
| 1.1 | Technical data..... | 4 |
| 2 | Installation..... | 4 |
| 2.1 | Unpacking..... | 4 |
| 2.2 | Installation into the system..... | 4 |
| 2.3 | Admissible forces..... | 5 |
| 2.4 | Tightening torque for mounting screws on flanges..... | 5 |
| 2.5 | Electrical connection..... | 6 |
| 2.5.1 | Electrical connection position indicator..... | 7 |
| 3 | Operation..... | 7 |
| 3.1 | Normal operation..... | 7 |
| 3.2 | Admissible temperature..... | 7 |
| 4 | Trouble shooting..... | 8 |
| 5 | Maintenance & repairs..... | 8 |
| 5.1 | Cleaning of the sealing surface..... | 9 |
| 5.2 | Exchange of gate o-ring and gliders..... | 10 |
| 5.3 | Exchange of bellows feedthrough unit..... | 11 |
| 6 | Drawing..... | 13 |
| 7 | Spare parts..... | 14 |
| 8 | Warranty..... | 15 |



1 Use of product

Use product for clean and dry indoor vacuum applications under the conditions indicated in chapter «Technical data» only! Other applications are only allowed with the written permission of VAT.

1.1 Technical data

| | |
|--|--|
| Pressure range | 1 x 10 ⁻⁹ mbar to 1.2 bar (abs) |
| Differential pressure on the gate | ≤ 1.2 bar in either direction |
| Differential pressure at opening | ≤ 1.0 bar |
| Admissible temperature: Valve | ≤ 120°C |
| Pneumatic actuator | ≤ 80°C |
| Position indicator | ≤ 80°C |
| Solenoid | ≤ 50°C |
| Position indicator: contact rating (Option) | 12 - 30 V DC, max. 500mA, max. 10W |
| Further data according to product data sheet | |

2 Installation

2.1 Unpacking

Make sure, that the delivered components are according to order. Visually check the quality of the components. If something of the delivery is not as expected please immediately contact VAT.

Notice:

Please do not throw away the original packaging. It might be useful in a case of service to return the components to VAT

2.2 Installation into the system

The valve seat side is indicated by the symbol "∇" on the connection flange.

1. Clean the sealing surface and the O-ring seal of the mating flange.
2. Move the pendulum valve in the correct mounting position with the crane. **ATTENTION:** Do not hit the sealing surfaces during manipulation!
3. Set 2 screws in one line
4. Set two additional two screws 90° to the line which is build by the first two screws.
5. Fasten the 4 screws crosswise until the O-ring seal gets in contact with the valve sealing surface.
6. Apply all remaining screws
7. Fasten all screws gradually in crosswise order.

2.3 Admissible forces

Forces from evacuating the system, from the weight of other components, and from baking can lead to deformation of the valve body and to malfunction of the valve. The stress has to be relieved by suitable means, e.g. bellows sections. The following forces are admissible:

| DN (nom. I.D.) | | Axial tensile or compressive force «FA» | | Bending moment «M» | |
|----------------|-------|---|-----|--------------------|----------|
| mm | inch | N | lbf | Nm | lbf • ft |
| 63 | 2 1/2 | 1960 | 440 | 78 | 58 |
| 80 | 3 | 2450 | 560 | 98 | 72 |
| 100 | 4 | 2450 | 560 | 98 | 72 |
| 160 | 6 | 2940 | 660 | 147 | 108 |

If a combination of both forces («FA» and «M») occurs, the values mentioned above are invalid. Please contact VAT for more information.

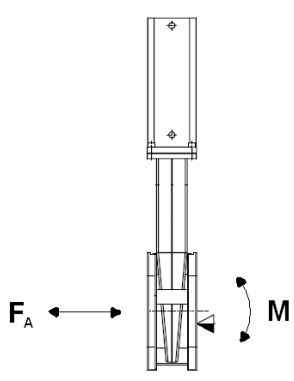

2.4 Tightening torque for mounting screws on flanges

1. Mounting with centering ring

Tighten mounting screws of the flanges uniformly in crosswise order. Observe the maximum torque levels in the following table. Higher tightening torques deform the valve body and can lead to an improper function of the valve.

| DN | | max. tightening torque (Nm) | | | max. tightening torque (lbs . ft) | | |
|-----|-------|-----------------------------|--|--|-----------------------------------|--|--|
| mm | inch | ISO-F | | | ISO-F | | |
| 63 | 2 1/2 | 8 – 10 | | | 6 – 8 | | |
| 80 | 3 | 8 – 10 | | | 6 – 8 | | |
| 100 | 4 | 8 – 10 | | | 6 – 8 | | |
| 160 | 6 | 13 - 15 | | | 9 – 11 | | |

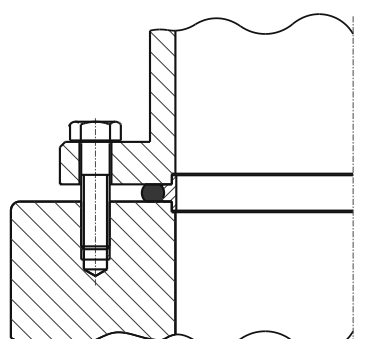
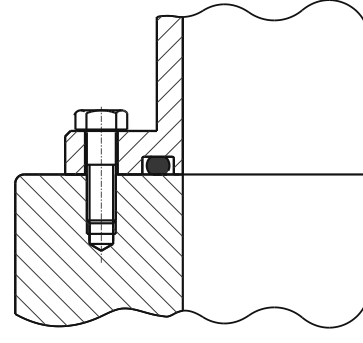

Table 1

2. Mounting with O-ring in groove

Tighten mounting screws on the flanges uniformly in crosswise order. Observe the maximum torque according to the grade of screws and depth of thread you use.



2.5 Electrical connection



Do not touch electrical parts under voltage!



Connect electrical power only if

- valve has been installed into the vacuum system
- moving parts cannot be touched

Verify that mains voltage matches voltage stated on the solenoid! Sockets for position indicator and solenoid are supplied with the valve.

Wire position indicator (option) according to the following diagrams:

2.5.1 Electrical connection position indicator

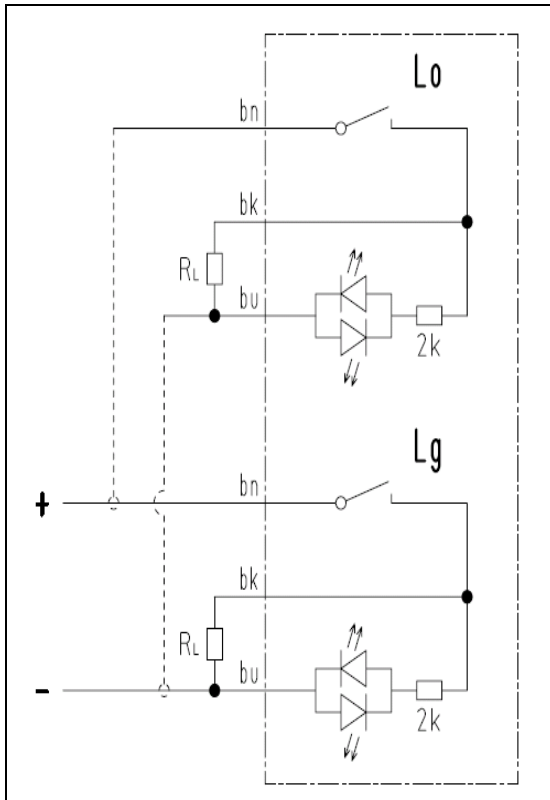

| | |
|------------------------------------|-----------------------------|
| Operating voltage range | 12.....30V AC / DC (=Vb) |
| Max. permitted residual ripple | ±10% Vb |
| Max. permitted switching current | 500 mA |
| Max. permitted switching output | 10 W (Ohmic load) |
| Response time | < 0.5 ms |
| Max. permitted switching frequency | 800 Hz |
| Short-circuit –proof | no |
| Polarity-reversal protection | no |

Electrical connection

bn: Brown
bk: Black
bu: Blue

| | |
|---|------------------|
| Ambient temperature (cable immobile) | -20 °C....+60 °C |
| (cable moveable) | -5 °C....+60 °C |
| Storage temperature | -20 °C +60 °C |

| | |
|------------------|--------------------------------|
| Protection class | IP65/67 according EN 60 529 |
| Housing Material | PC, PET, Epoxy resin |

| | |
|----------------|-----|
| Cable material | PUR |
|----------------|-----|

Lo :Position indicator for valve gate in open position
Lg: Position indicator for valve gate in closed position

3 Operation

3.1 Normal operation

Valve is opened and closed by the manual actuator.

3.2 Admissible temperature

The maximum temperatures indicated in the technical data are only valid as long as the valves is in one of the end positions. Cycling the valve at these temperatures may reduce the cycle life of the mechanism. See "1.1 Technical

data".

4 Trouble shooting

| Failure | Check | Action |
|--|---|--|
| Valve does not open or close | Compressed air pressure | Verify compressed air pressure |
| Valve does not open or close | Power at solenoid | Verify electrical power |
| Valve is no more leak tight at seat | Check cleanliness at seat surface Check gate O-ring | Clean the sealing surface Exchange the gate O-ring |
| Valve is no more leak tight to the outside | Check bonnet cover O-ring Check valve flange O-rings Check the bellows feed through | Clean/Exchange the O-ring Clean/Exchange the O-rings Exchange the bellows feed through |

If you need any further information, please contact one of our service centers. You can find the addresses on our website: <http://www.vat.ch>

5 Maintenance & repairs

Under clean operating conditions, the valve does not require any maintenance during the specified cycle life. Contamination from the process may influence the function and requires more frequent maintenance.

Before carrying out any maintenance or repairs, please contact VAT. It has to be individually decided whether the maintenance/repair can be performed by the customer or has to be carried out by VAT. The fabrication number on the valve

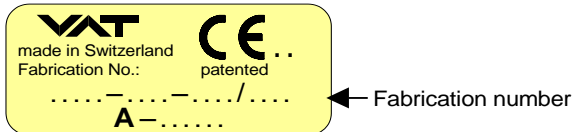

has always to be specified.

All supplies (e. g. compressed air, electrical power) must be disconnected for removal/installation of the valve from/into the system and for maintenance work.



Even with disconnected supply, loaded springs and/or air cushions in cylinders can be potential hazards.





Keep fingers and objects away from the valve opening!



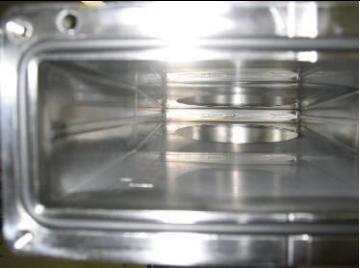
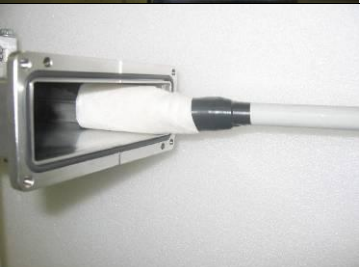

Products returned to VAT must be free of harmful substances such as e.g. toxic, caustic or microbiological ones. If products are radioactively contaminated, fill in the VAT form «Contamination and Radiation Report» and send it with the product. The form is available at VAT. The maximum values indicated in the form must not be exceeded.

5.1 Cleaning of the sealing surface

Please wear safety glasses if you start with any maintenance work on the valve.



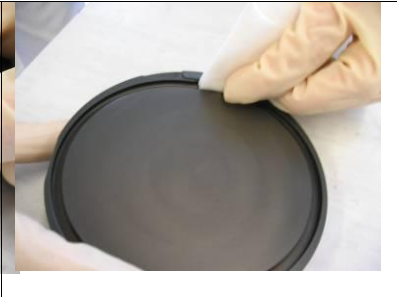



| | | |
|---|--|---|
|  | <p>Move the gate valve in the open position</p> <p>Disconnect the compressed air and electrical power from the gate valve during maintenance!</p> | |
| | <p>Open the bonnet cover flange with a 5mm allen key.</p> |  |
| | <p>Remove the valve insert from the valve body Do not touch the sealing surfaces with the gate</p> |  |
| | <p>Check the sealing surfaces for scratches and dirt inside of the body (easy visible through the wedge design).</p> |  |
| | <p>If necessary clean the sealing surfaces inside the valve body with an tissue and alcohol</p> |  |

5.2 Exchange of gate o-ring and gliders

| | | |
|---|--|---|
| | <ol style="list-style-type: none"> 1) Vent vacuum chamber on either side of the valve. 2) Open the valve by means of compressed air. 3) Switch off compressed air and power supply. 4) Disconnect compressed air and power supply lines from the valve. 5) Remove valve insert as described in section 5.1 . 6) Clean the gate o-ring with a tissue first and proceed with the visual inspection of the gate o-ring. |  |
| | <p>If the o-ring has scratches or if it is damaged proceed with the exchange of the o-ring. To get the o-ring out of the groove use a compressed air pistol right at the venting point of the groove like in the right picture. The o-ring will move out of the groove without any damage of the o-ring groove.</p> |  |
| <p>Remove the o-ring from the groove and clean the groove with alcohol.</p> |  |  |
| | <p>Remove the gate gliders from the valve gate with a little tool e.g. screwdriver. VAT recommends that whenever the gate o-ring is changed to also change the gliders on both sides of the gate..</p> |  |

5.3 Exchange of bellows feedthrough unit

| | | | |
|--|---|---|---|
| | <p>Open the valve gate fixation screw with a 5mm allen key holding back the gate. Do not twist the bellows feed through unit.</p> |  |  |
| | <p>Remove the valve gate from the valve insert assembly. Pull down the bellows feed through unit from the actuator shaft and exchange this part with a new one.</p> |  |  |
| | <p>Before mounting the new bellows feedthrough be aware about the flat encoding sections on the actuator shaft. This flat encoding section should orientate the valve gate later on.</p> |  | |
| | <p>Move the new bellows feedthrough unit on the actuator shaft until you can see the flat encoding sections for the valve gate, followed by the assemble of the o-ring onto the bellows feedthrough.</p> <p>Place the gate on the top of the shaft and turn it so that the encoding flats on the actuator shaft are in line with the corresponding grooves of the valve gate.</p> |  |  |

| | | | |
|---|--|--|---|
|  | <p>Reinstall the fixation screw with an new O-ring and thighten it with a 5mm torque allen wrench. Thighten the gate fixation screw with the torque wrench to the specified torque of 8Nm. Change gate seal on the bonnet.</p> |  |  |
|  | <p>Slide the gate valve insert back into the valve body housing. Make sure that the gate O-ring shows towards the seat side marking ▽ shown on the side surface of the body flange. Tighten the bonnet flange screws with the 5mm allen key.</p> |  |  |

6 Drawing

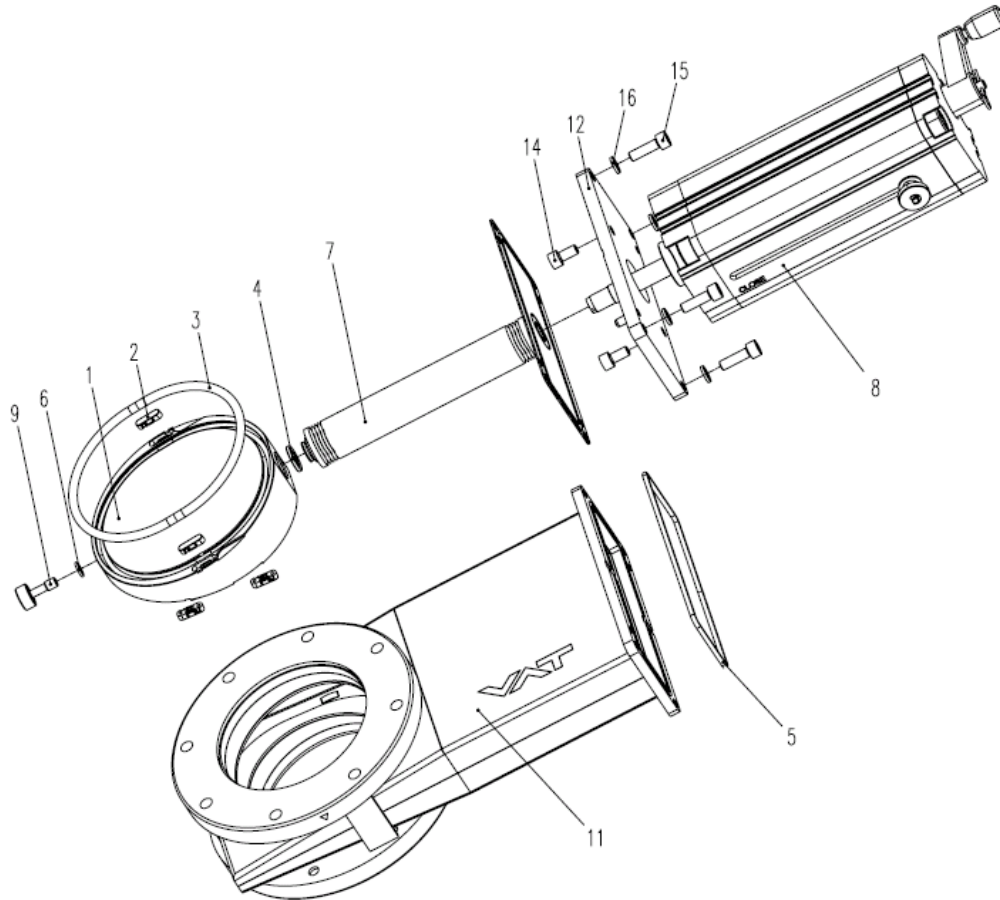

| Item | Description | Item | Description |
|------|----------------------------|------|--------------------|
| 1 | Gate (SS) | 9 | Gate Allen screw |
| 2 | Glider | 10 | - |
| 3 | Gate o-ring | 11 | Valve body |
| 4 | Bellows feedthrough o-ring | 12 | Bonnet flange |
| 5 | Bonnet flange o-ring | 13 | - |
| 6 | Gate Screw o-ring | 14 | Bonnet Allen screw |
| 7 | Bellows feedthrough | 15 | Allen Screw |
| 8 | Manual actuator | 16 | Washer |

7 Spare parts



Please specify the **fabrication number of the valve** (see yellow label on valve) when ordering spare parts. This is to ensure that the appropriate spare parts are supplied.

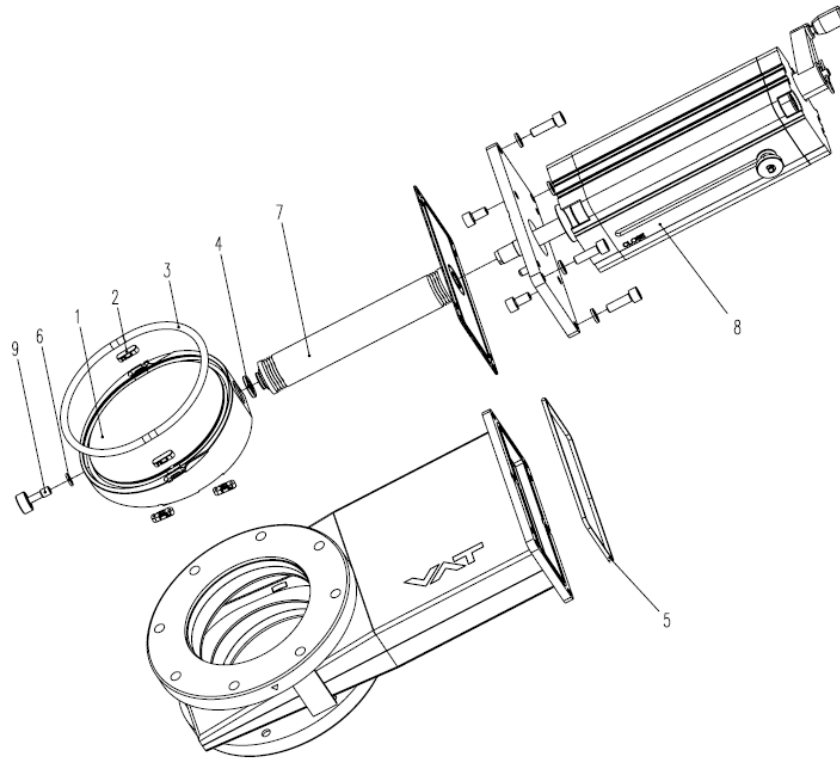

| Part no. | Description | Position | Req.qty | Remarks |
|----------|----------------------------------|-----------|---------|---------|
| 255572 | Bellows Feedthrough DN63 | 7 | 1 | |
| 253807 | Bellows Feedthrough DN80 and 100 | 7 | 1 | |
| 255727 | Bellows Feedthrough DN160 | 7 | 1 | |
| 256696 | Seal Kit Vacuum DN63 | 2,3,4,5,6 | 1 | |
| 256021 | Seal Kit Vacuum DN80 and 100 | 2,3,4,5,6 | 1 | |
| 256031 | Seal Kit Vacuum DN160 | 2,3,4,5,6 | 1 | |
| 262443 | Gate DN63 | 1 | 1 | |
| 262444 | Gate DN80 and 100 | 1 | 1 | |
| 262445 | Gate DN160 | 1 | 1 | |



8 Warranty

Each product sold by VAT Vakuumventile AG (VAT) is warranted to be free from the manufacturing defects that adversely affect the normal functioning thereof during the warranty period stated in VAT's «Terms of Sale» immediately following delivery thereof by VAT, provided that the same is properly operated under conditions of normal use and that regular, periodic maintenance and service is performed or replacements made, in accordance with the instructions provided by VAT. The foregoing warranty shall not apply to any product or component that has been repaired or altered by anyone other than an authorized VAT representative or that has been subject to improper installation or abuse, misuse, negligence or accident. VAT shall not be liable for any damage, loss, or expense, whether consequential, special, incidental, direct or otherwise, caused by, arising out of or connected with the manufacture, delivery (including any delay in or failure to deliver), packaging, storage or use of any product sold or delivered by VAT shall fail to conform to the foregoing warranty or to the description thereof contained herein, the purchaser thereof, as its exclusive remedy, shall upon prompt notice to VAT of any such defect or failure and upon the return of the product, part or component in question to VAT at its factory, with transportation charges prepaid, and upon VAT's inspection confirming the existence of any defect inconsistent with said warranty or any such failure, be entitled to have such defect or failure cured at VAT's factory and at no charge therefor, by replacement or repair of said product, as VAT may elect. VAT MAKES NO WARRANTY OR REPRESENTATION OF ANY KIND, EXPRESS OR IMPLIED, (INCLUDING NO WARRANTY OR MERCHANTABILITY), EXCEPT FOR THE FOREGOING WARRANTY AND THE WARRANTY THAT EACH PRODUCT SHALL CONFORM TO THE DESCRIPTION THEREOF CONTAINED HEREIN, and no warranty shall be implied by law.

Furthermore, the «Terms of sale» at the back of the price list are applicable.