

# Installation, Operating & Maintenance Instructions

---



## HV gate valve with pneumatic actuator

**Series 091**  
**DN 50–160 mm (I. D. 2"–6")**

This manual is valid for the following product ordering numbers:  
**091 . . . E14/24/34/44**

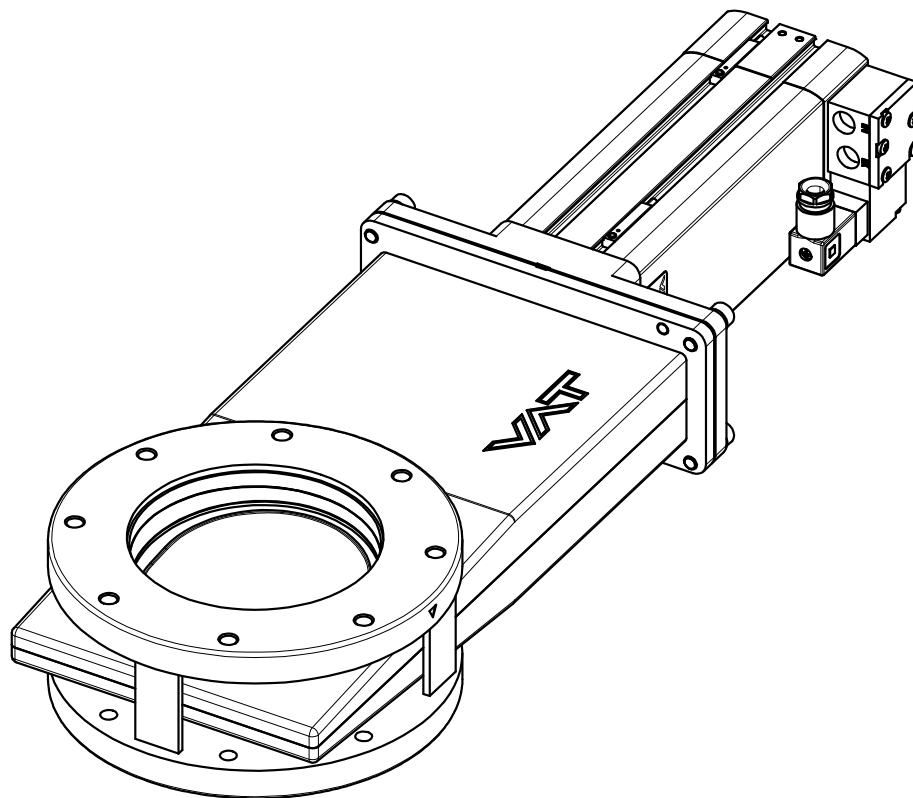

Sample picture

## Imprint

Manufacturer VAT Vakuumventile AG, CH-9469 Haag, Switzerland

Website: [www.vatvalve.com](http://www.vatvalve.com)  
Phone: +41 81 771 61 61  
Fax: +41 81 771 48 30  
Email: [CH@vatvalve.com](mailto:CH@vatvalve.com)

Publisher VAT Vakuumventile AG, CH-9469 Haag, Switzerland

Editor VAT Vakuumventile AG, CH-9469 Haag, Switzerland

Print VAT Vakuumventile AG, CH-9469 Haag, Switzerland

Copyright © VAT Vakuumventile AG 2014

No part of these instructions may be reproduced in any way (photocopies, microfilms or any other reproduction processes) nor may it be manipulated with electronic systems, duplicated or distributed without written permission from VAT. Offenders are liable to pay damages.

The original VAT firmware and updated state of the art versions of the VAT firmware are intended for use with VAT products. The VAT firmware contains a limited, time unlimited user license. The VAT firmware may not be used for purposes other than those intended nor is it permitted to make copies of the VAT firmware. In particular, it is strictly forbidden to give copies of the VAT firmware to other people.

The use of trade names, brand names, trademarks, etc. in these Instructions does not entitle third parties to consider these names to be unprotected and to use them freely. This is in accordance with the meaning of the laws and acts covering brand names and trademarks.

## Contents

<b>1</b>	<b>Description of product.....</b>	<b>4</b>
1.1	Identification of product.....	4
1.2	Use of product.....	4
1.3	Related documents.....	4
1.4	Important information.....	4
1.5	Technical data.....	4
<b>2</b>	<b>Safety .....</b>	<b>5</b>
2.1	Compulsory reading material .....	5
2.2	Danger levels .....	5
2.3	Personnel qualifications.....	6
2.4	Safety labels.....	6
<b>3</b>	<b>Design and Function.....</b>	<b>7</b>
3.1	Design.....	7
3.2	Design.....	7
<b>4</b>	<b>Installation .....</b>	<b>8</b>
4.1	Unpacking .....	8
4.2	Installation into the system.....	8
4.2.1	Admissible forces and bending moments .....	10
4.3	Compressed air connection .....	11
4.4	Electrical connection.....	11
<b>5</b>	<b>Operation .....</b>	<b>12</b>
5.1	Normal operation.....	12
5.2	Operation under increased temperature.....	12
5.3	Behavior in case of compressed air pressure drop.....	12
5.4	Behavior in case of power failure .....	12
5.4.1	Manual emergency operation.....	12
5.5	Trouble shooting.....	14
<b>6</b>	<b>Maintenance .....</b>	<b>15</b>
6.1	Maintenance intervals.....	15
6.2	Required tools .....	15
6.3	Cleaning of the valve gate and body .....	16
<b>7</b>	<b>Repairs.....</b>	<b>20</b>
<b>8</b>	<b>Dismounting and Storage.....</b>	<b>21</b>
8.1	Dismounting .....	22
8.2	Storage .....	22
<b>9</b>	<b>Packaging and Transport .....</b>	<b>23</b>
9.1	Packaging .....	24
9.2	Transport.....	24
<b>10</b>	<b>Disposal .....</b>	<b>25</b>
<b>11</b>	<b>Spare parts .....</b>	<b>26</b>

# 1 Description of product

## 1.1 Identification of product

The fabrication number and order number are fixed on the product directly or by means of an identification plate.



← Fabrication number

← Order number

## 1.2 Use of product

Use product for clean and dry vacuum applications only. Other applications are only allowed with the written permission of VAT.

## 1.3 Related documents

- Product data sheet
- Dimensional drawing

## 1.4 Important information



This symbol points to a very important statement that requires particular attention.

### Example:



VAT disclaims any liability for damages resulting from inappropriate packaging.

## 1.5 Technical data

See product data sheet and dimensional drawing.

## 2 Safety

### 2.1 Compulsory reading material

Read this chapter prior to performing any work with or on the product. It contains important information that is significant for your own personal safety. This chapter must have been read and understood by all persons who perform any kind of work with or on the product during any stage of its serviceable life.

	NOTICE
	<p><b>Lack of knowledge</b> Failing to read this manual may result in property damage. Firstly, read manual.</p>





These Installation, Operating & Maintenance Instructions are an integral part of a comprehensive documentation belonging to a complete technical system. They must be stored together with the other documentation and accessible for anybody who is authorized to work with the system at any time.

### 2.2 Danger levels

	⚠ DANGER
	<p><b>High risk</b> Indicates a hazardous situation which, if not avoided, will result in death or serious injury.</p>

	⚠ WARNING
	<p><b>Medium risk</b> Indicates a hazardous situation which, if not avoided, could result in death or serious injury.</p>

	⚠ CAUTION
	<p><b>Low risk</b> Indicates a hazardous situation which, if not avoided, may result in minor or moderate injury.</p>

	NOTICE
	<p><b>Command</b> Indicates a hazardous situation which, if not avoided, may result in property damage.</p>

### 2.3 Personnel qualifications

	<b>WARNING</b>
	<p><b>Unqualified personnel</b>                  Inappropriate handling may cause serious injury or property damage.                  Only qualified personnel are allowed to carry out the described work.</p>

### 2.4 Safety labels

Label	Part No.	Location on valve
	T-9001-155	Protective cover

Table 2-1

### 3 Design and Function

#### 3.1 Design

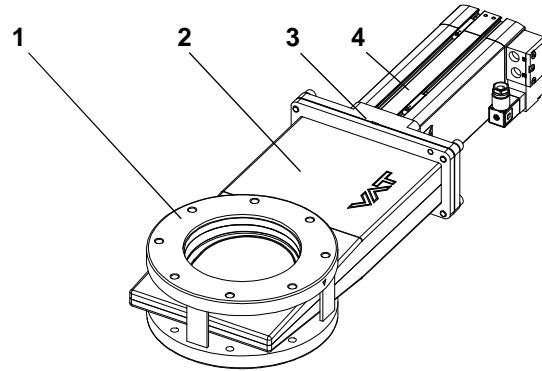

- 1 Sealing surface
- 2 Valve body
- 3 Bonnet flange
- 4 Actuator

Figure 3-1

#### 3.2 Design

The valve sealing principle is based on a wedge shape gate design. The gate seal is pressed against the sealing surface by means of a pneumatic actuator. The valve is standard equipped with a bellows feedthrough. Optional the valve can be equipped with a shaft feedthrough, with or without PTFE protection bellows.

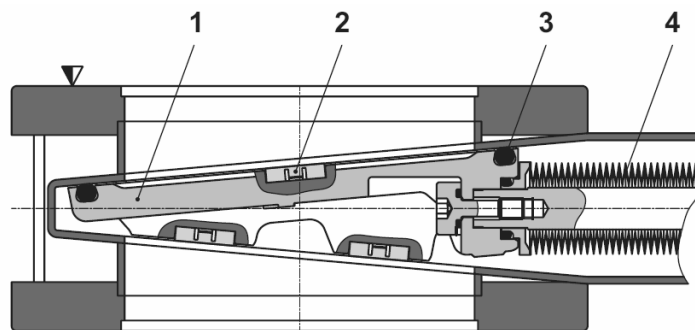

- 1 Gate
  - 2 Sliding elements
  - 3 Gate seal
  - 4 Bellows
- ▽ Valve seat side

Figure 3-2

## 4 Installation

	<b>WARNING</b>
	<p><b>Unqualified personnel</b>                  Inappropriate handling may cause serious injury or property damage.                  Only qualified personnel are allowed to carry out the described work.</p>

### 4.1 Unpacking



- Make sure that the supplied products are in accordance with your order.
- Inspect the quality of the supplied products visually. If it does not meet your requirements, please contact VAT immediately.
- Store the original packaging material. It may be useful if products must be returned to VAT.

### 4.2 Installation into the system

	<b>WARNING</b>
	<p><b>Movable parts</b>                  Human body parts may get jammed and severely injured.                  Do not connect or supply electrical power and compressed air before the product is completely mounted in the system.</p>

	<b>NOTICE</b>
	<p><b>Contamination</b>                  Product may get contaminated.                  Always wear cleanroom gloves when handling the product.</p>

	<b>NOTICE</b>
	<p><b>Inappropriate tools</b>                  Sealing surfaces may get damaged.                  Do not use sharp-edged tools.</p>



<b>NOTICE</b>	
	<p><b>Wrong tightening torque</b></p> <p>Valve body and screws may get damaged. Use tightening torque according the size of the screws.</p>

<b>NOTICE</b>	
	<p><b>Too long screws</b></p> <p>Valve body may get deformed and / or malfunctions may occur. Use only screws recommended by VAT.</p>

Identify flange type according the fabrication number on the identification plate;  
see Example: 091 . . – P . . . / . . . = Flange type ISO-F.

Valve			Maximum screw-in depth «G» in mm				
Nom. I.D.			Flange types				
mm	inch		C	U	P	J	T
63	2½	G =	12	12	12	12	12
80	3	G =	12	12	12	12	12
100	4	G =	12	12	12	12	12
160	6	G =	12	12	15	15	15

C = CF-F, metric thread  
 U = CF-F, UNF thread  
 P = ISO-F  
 J = JIS  
 T = ASA-LP

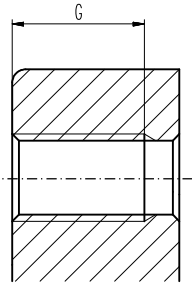

Table 4-1

### 4.2.1 Admissible forces and bending moments



Forces from evacuating the system, from the weight of other components or from baking can lead to deformation of the valve body and to malfunction of the valve. The stress has to be relieved by suitable means; e. g. bellows sections.

The following forces or bending moments are admissible:

DN (nom. I.D.)		Axial tensile or compressive force «FA»		Bending moment «M»	
mm	inch	N	lbf	Nm	lbf · ft
50	2	500	112	30	22
63	2½	1960	440	78	58
80	3	2450	560	98	72
100	4	2450	560	98	72
160	6	2940	660	147	108
If a combination of both forces («FA» and «M») occurs, the values mentioned above are invalid. Please contact VAT for more information.					

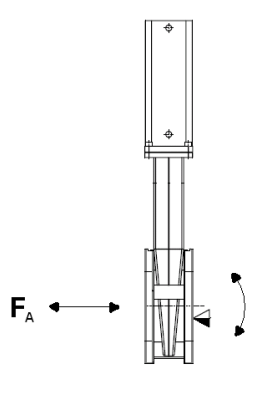

Table 4-2

1. Remove protective covers from body flanges.
2. Clean sealing surfaces and seals of both flanges; see (1) and (2) according to «Figure 4-1».



The valve seat side is marked with the symbol «▼» on flange «A».

3. Lift valve to the mounting position.
4. Mount the four screws (3) according to «Figure 4-1», evenly in crosswise order until the seal touches the sealing surface.

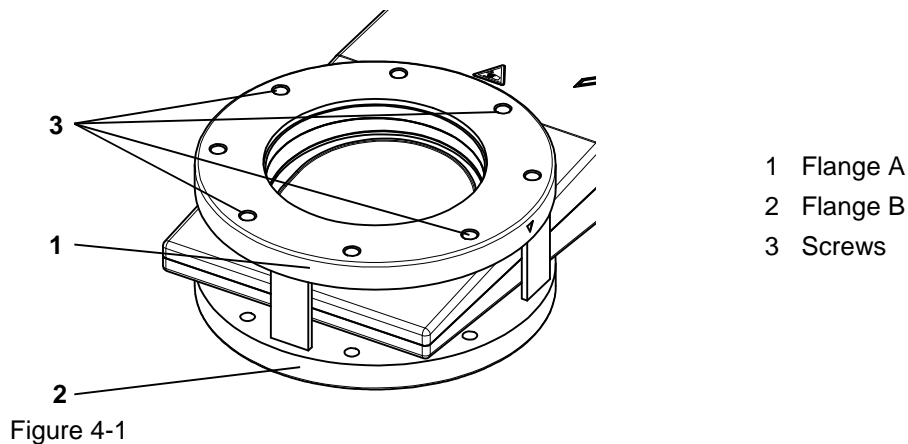



Figure 4-1

5. Tighten all screws with the torques appropriate for their property classes.

### 4.3 Compressed air connection

	<b>⚠ WARNING</b>
	<p><b>Valve in open position</b></p> <p>Risk of injury when compressed air is connected to the valve.</p> <p>Connect compressed air only when:</p> <ul style="list-style-type: none"> <li>– valve is installed in the vacuum system</li> <li>– moving parts cannot be touched</li> </ul>



Use clean, dry or slightly oiled air only.



Admissible air pressure range, see product data sheet.

1. Connect compressed air according to the product data sheet and dimensional drawing.

### 4.4 Electrical connection

	<b>⚠ DANGER</b>
	<p><b>Electric shock</b></p> <p>Parts being under voltage will result in serious injury or death.</p> <p>Do not touch parts being under voltage.</p>



#### NOTICE

**Wrong voltage**

Electrical components may get damaged.  
Supply electrical components with the correct voltage.

1. Connect solenoid valve according to the product data sheet and dimensional drawing.
2. Connect position indicator according to the product data sheet and dimensional drawing.
3. Connect heater (option) according to the product data sheet and dimensional drawing.

## 5 Operation

	<b>WARNING</b>
	<p><b>Unqualified personnel</b>            Inappropriate handling may cause serious injury or property damage.            Only qualified personnel are allowed to carry out the described work.</p>

	<b>WARNING</b>
	<p><b>Movable parts</b>            Human body parts may get jammed and severely injured.            Do not operate before product is installed completely into the vacuum system.</p>

### 5.1 Normal operation

Valve is opened and closed pneumatically.

### 5.2 Operation under increased temperature

Maximum allowed temperature, see product data sheet.

### 5.3 Behavior in case of compressed air pressure drop

See product data sheet.

### 5.4 Behavior in case of power failure

See product data sheet.

#### 5.4.1 Manual emergency operation

	<b>WARNING</b>
	<p><b>Movable parts</b>            Human body parts may get jammed and severely injured.            Keep human body parts away from movable parts.</p>



Only valid for the ordering number 091...-..44 (with solenoid valve)

In case of a power failure, the valve can be actuated manually if compressed air is available.

#### Standard solenoid valve

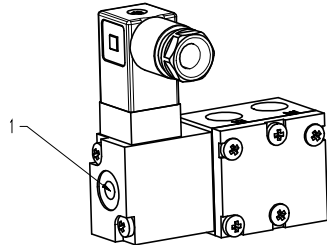

Press push-button (1): valve opens  
Release push-button (1): valve closes

#### Solenoid valve with lockable emergency operation (option)

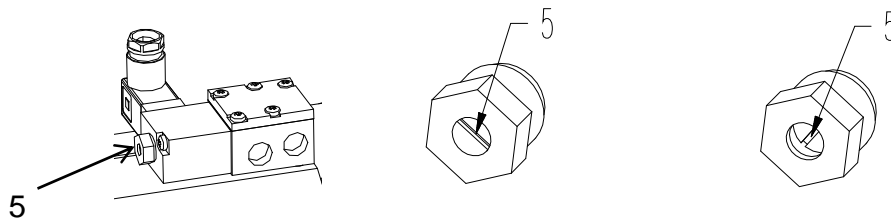

Standard solenoid valve  
with manual emergency  
operation (5)

Solenoid valve In  
"NORMAL" position

Solenoid valve In "MANUAL"  
position (push and turn 90°)

#### Solenoid valve for impulse actuation (option)

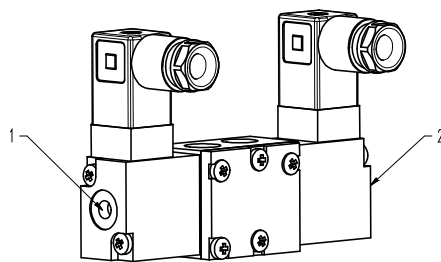

Press push-button (1): valve opens  
Press push-button (2): valve closes

## 5.5 Trouble shooting

Failure	Check	Action	See
Valve does not close / open	Air pressure	Connect compressed air	«4.3 Compressed air connection»
	Operating pressure	Adjust operating pressure	Product data sheet
	Voltage at solenoid valve	Connect voltage	«4.4 Electrical connection»
Leak at gate	Gate seal all right?	Replace gate seal	«6.3 Cleaning of the valve gate and body»
	Gate damaged or contaminated?	Contact VAT	<a href="http://www.vatvalve.com">www.vatvalve.com</a>
	Operating pressure	Adjust operating pressure	Product data sheet
Leak at body	Bonnet seal and sealing surface all right?	Clean sealing surface, if necessary, replace bonnet seal	«6.3 Cleaning of the valve gate and body»



Table 5-1



If you need any further information, please contact one of our service centers. You will find the addresses on our website [www.vatvalve.com](http://www.vatvalve.com).



## 6 Maintenance



Ensure that the maintenance technician is familiar with the safety precautions which relate to the product. Wear appropriate safety clothing when you come into contact with contaminated components. Dismantle and clean contaminated components inside a fume cupboard.

	 <b>WARNING</b>
	<p><b>Unqualified personnel</b></p> <p>Inappropriate handling may cause serious injury or property damage. Only qualified personnel are allowed to carry out the described work.</p>

	 <b>WARNING</b>
	<p><b>Hazardous components</b></p> <p>Human body parts may get jammed and severely injured.</p> <p>Before starting maintenance:</p> <ul style="list-style-type: none"> <li>– disconnect compressed air supply</li> <li>– disconnect electrical power supply</li> </ul>

	 <b>WARNING</b>
	<p><b>Movable parts</b></p> <p>Human body parts may get jammed and severely injured.</p> <p>Keep human body parts away from movable parts.</p>

### 6.1 Maintenance intervals

Under clean operating conditions the valve does not require any maintenance during specified service lifetime; see product data sheet. Contamination from the process may influence the function and requires more frequent maintenance. After these cycles, VAT recommends to clean the gate seal or if needed, replace the gate seal.

For more information or a general overhaul please contact one of our service centers. You will find the addresses on our website [www.vatvalve.com](http://www.vatvalve.com).

### 6.2 Required tools

- Allen wrench
- Screwdriver
- Cleanroom wiper soaked with alcohol (2% methyl ethyl ketone)
- O-Ring removal tool; see «Table 11-1» on page 26.

### 6.3 Cleaning of the valve gate and body

	<b>⚠ WARNING</b>
	<b>Loaded spring steel sheet</b> Human body parts may get jammed and severely injured. Do not put human body parts between valve gate and spring steel sheet.

	<b>NOTICE</b>
	<b>Contamination</b> Product may get contaminated. Always wear cleanroom gloves when handling the product.

	<b>NOTICE</b>
	<b>Inappropriate tools</b> Sealing surfaces may get damaged. Do not use sharp-edged tools.

 Do not clean the O-ring with alcohol, because alcohol may damage the surface of the O-rings, we recommend to treat the O-rings with a small amount of vacuum grease.

1. Vent chambers on either side of the valve to atmospheric pressure.
2. Open the valve.
3. Disconnect compressed air supply.
4. Disconnect electrical power supply.
5. Remove screws (1); see «Figure 6-1» on page 17.



6. Pull out valve insert (2) from valve body (3); see «Figure 6-1».

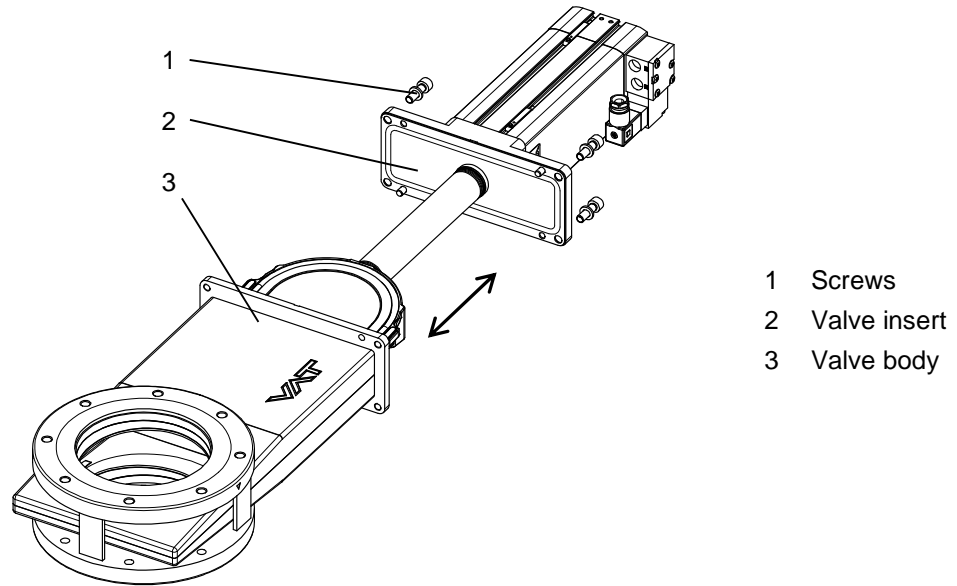

Figure 6-1

7. Identify seat side marker "▼"; see «Figure 6-2».

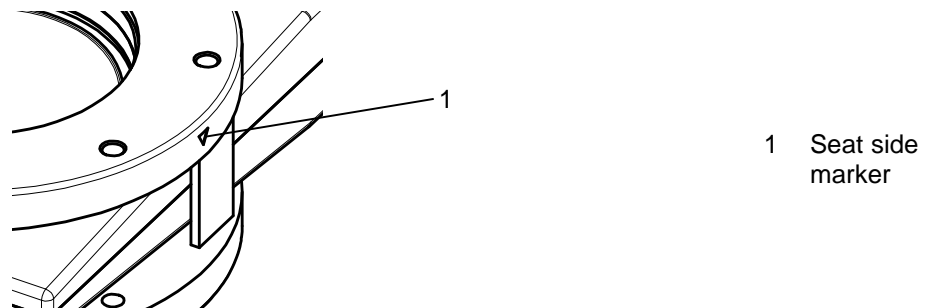
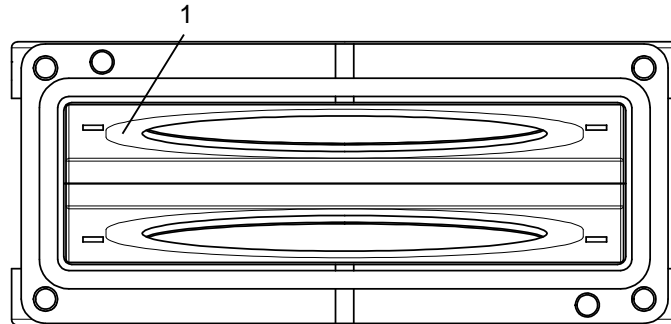

Figure 6-2

8. Clean gate sealing surfaces (1) (seat side) and other surfaces inside valve body; see «Figure 6-3».



1 Sealing surface

Figure 6-3

9. Clean or replace the gate O-ring (13); see «Figure 6-5» on page 19, use O-ring removal tool.



VAT recommends that whenever the gate O-ring is changed to also change the gliders (Peek-tabs) on both sides of the gate; see item 11 and 12.

10. Continue with step 13 when the gliders are not replaced.
11. Remove gliders from the front and backside of the gate with a small, edge shaped tool e.g. screwdriver. Squeeze tool into gap between glider and gate (a); see «Figure 6-4». Push down the tool (b) to release glider from pocket and remove glider (c).

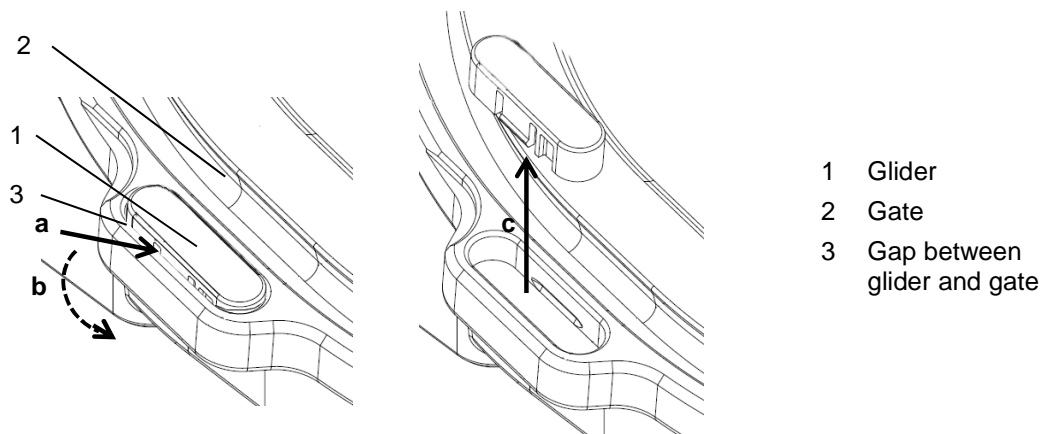

1 Glider  
2 Gate  
3 Gap between glider and gate

Figure 6-4

12. Mount the gliders (1) by gently pushing the gliders in the designated pockets in the gate.

13. Clean or replace bonnet O-ring (7); see «Figure 6-5»; use O-ring removal tool.
14. Clean sealing surface of bellows (6); see «Figure 6-5».



Do not damage or scratch O-ring sealing surface.

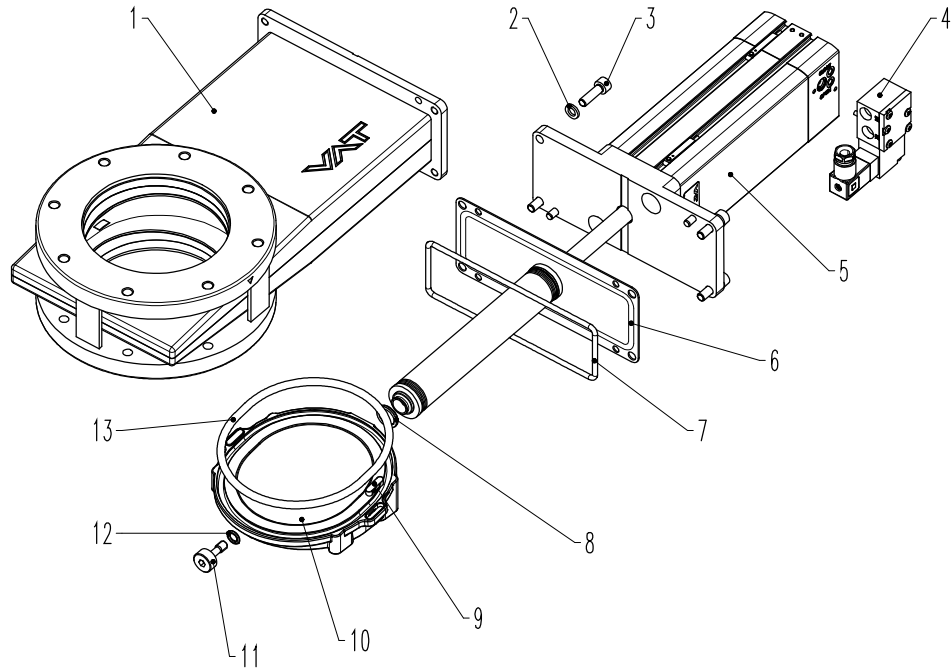

- 6 Bellows sealing surface
- 7 Bonnet O-ring
- 13 Gate O-ring

Figure 6-5

15. Mount valve insert (2) into the valve body (3); «Figure 6-1» on page 17. Assure that the gate O-ring is facing the valve body seat side marker "▼"; see «Figure 6-2» on page 17.
16. Mount screws (1) according to «Figure 6-1» on page 17.
17. Connect compressed air supply.
18. Connect electrical power supply.





Valve is ready for use.

## 7 Repairs

Repairs may VAT service staff. In exceptional cases, the customer is allowed to carry out the repairs, but only with the prior consent of VAT.

Please contact one of our service centers. You will find the addresses on our website [www.vatvalve.com](http://www.vatvalve.com).

## 8 Dismounting and Storage

	<p style="text-align: center;"><b>⚠ WARNING</b></p> <p><b>Unqualified personnel</b> Inappropriate handling may cause serious injury or property damage. Only qualified personnel are allowed to carry out the described work.</p>
	<p style="text-align: center;"><b>⚠ WARNING</b></p> <p><b>Hazardous components</b> Human body parts may get jammed and severely injured. Before dismantling the product</p> <ul style="list-style-type: none"><li>- disconnect compressed air supply</li><li>- disconnect electrical power supply</li></ul>
	<p style="text-align: center;"><b>⚠ WARNING</b></p> <p><b>Movable parts</b> Human body parts may get jammed and severely injured. Keep human body parts away from movable parts.</p>
	<p style="text-align: center;"><b>NOTICE</b></p> <p><b>Contamination</b> Product may get contaminated. Always wear cleanroom gloves when handling the product.</p>

## 8.1 Dismounting

	<b>NOTICE</b>
	<p><b>Valve in open position</b></p> <p>Valve mechanism may get damaged if valve is in open position. Close valve before dismounting the valve from the system.</p>

1. Close valve.
2. Carry out the steps according to chapter «4 Installation» in reverse order.  
Pay attention to the safety instructions.

## 8.2 Storage

	<b>NOTICE</b>
	<p><b>Wrong storage</b></p> <p>Inappropriate temperatures and humidity may cause damage to the product. Valve must be stored at:</p> <ul style="list-style-type: none"><li>– relative humidity between 10% and 70%</li><li>– temperature between +10 °C and +50 °C</li><li>– non-condensing environment</li></ul>

	<b>NOTICE</b>
	<p><b>Inappropriate packaging</b></p> <p>Product may get damaged if inappropriate packaging material is used. Always use the original packaging material and handle product with care.</p>

1. Clean / decontaminate valve.
2. Cover all valve openings with a protective foil.
3. Pack valve appropriately, by using the original packaging material.

## 9 Packaging and Transport

	<b>⚠ WARNING</b>
	<b>Unqualified personnel</b> Inappropriate handling may cause serious injury or property damage. Only qualified personnel are allowed to carry out the described work.

	<b>⚠ WARNING</b>
	<b>Harmful substances</b> Risk of injury in case of contact with harmful substances. Remove harmful substances (e. g. toxic, caustic or microbiological ones) from valve before you return the valve to VAT.

	<b>NOTICE</b>
	<b>Inappropriate packaging</b> Product may get damaged if inappropriate packaging material is used. Always use the original packaging material and handle product with care.



- When returning products to VAT, please fill out the VAT form «Declaration of Chemical Contamination» and send it to VAT in advance. The form can be downloaded from our website [www.vatvalve.com](http://www.vatvalve.com).
- If products are radioactively contaminated, the VAT form «Contamination and Radiation Report» must be filled out. Please contact VAT in advance.
- If products are sent to VAT in contaminated condition, VAT will carry out the decontamination procedure at the customer's expense.

## 9.1 Packaging

<b>NOTICE</b>	
	<p><b>Valve in open position</b> Valve mechanism may get damaged if valve is in open position. Make sure that the valve is closed.</p>

1. Cover all valve openings with a protective foil.
2. Pack valve appropriately, by using the original packaging material.



VAT disclaims any liability for damages resulting from inappropriate packaging.

## 9.2 Transport



<b>NOTICE</b>	
	<p><b>Inappropriate packaging</b> Product may get damaged if inappropriate packaging material is used. Always use the original packaging material and handle product with care.</p>



VAT disclaims any liability for damages resulting from inappropriate packaging.



## 10 Disposal

	 <b>WARNING</b>	
	<b>Harmful substances</b> Environmental pollution. Discard products and parts according to the local regulations.	

## 11 Spare parts

	NOTICE
<p><b>Non-original spare parts</b>                  Non-original spare parts may cause damage to the product.                  Use original spare parts from VAT only.</p>	



- Please specify the fabrication number of the product when you place an order for spare parts; see chapter «1.1 Identification of product». This is to ensure that the appropriate spare parts are supplied.
- VAT makes a difference between spare parts that may be replaced by the customer and those that need to be replaced by the VAT service staff.
- «Table 11-1» only contains spare parts that may be replaced by the customer. If you need any other spare parts, please contact one of our service centers. You will find the addresses on our website [www.vatvalve.com](http://www.vatvalve.com).

Description	Part No.	Quantity per valve	Maintenance procedure see chapter
Seal kit	On request	1	«6.3 Cleaning of the valve gate and body»
Gate O-ring	On request	1	«6.3 Cleaning of the valve gate and body»
Glider	On request	1	«6.3 Cleaning of the valve gate and body»
Bonnet flange O-ring	On request	1	«6.3 Cleaning of the valve gate and body»
O-ring removal tool	234859	1	«6.3 Cleaning of the valve gate and body»

Table 11-1