

2xM5 (10-32 UNF suitable) in air cylinder if adapter plate is removed

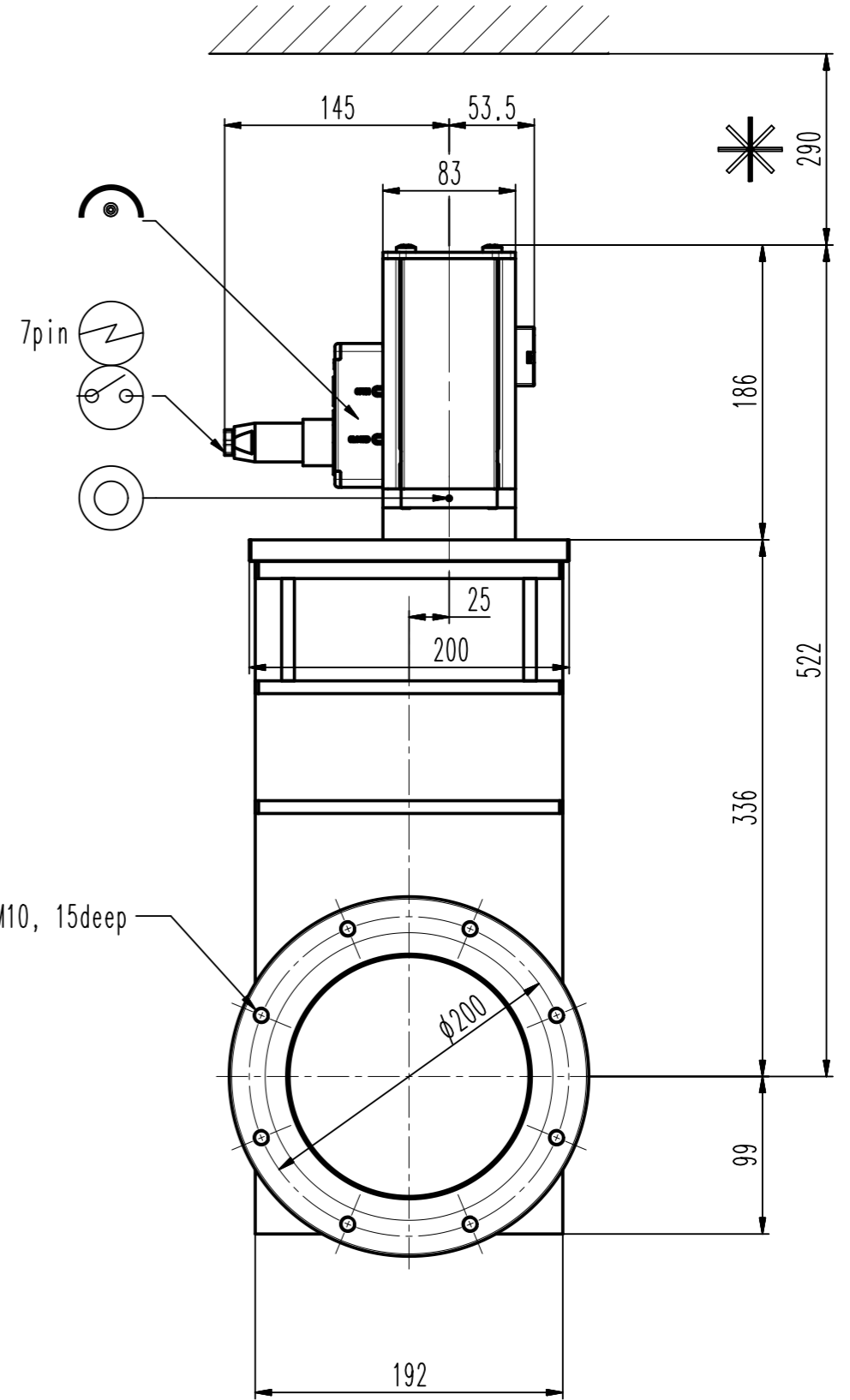

- ▼ Seat side
- ⊙ Comp. air connection
- ⊕ Electrical connection
- ⊖ Leak detection port
- ⊙ Mech. pos. indication
- ⊙ Position indicator
- ⊙ Required for dismantling
- ⊙ Emergency actuation
- ⊙ For attachment
- ⊙ Bake-out area
- ⊙ Differential pumping port

UHV gate valve

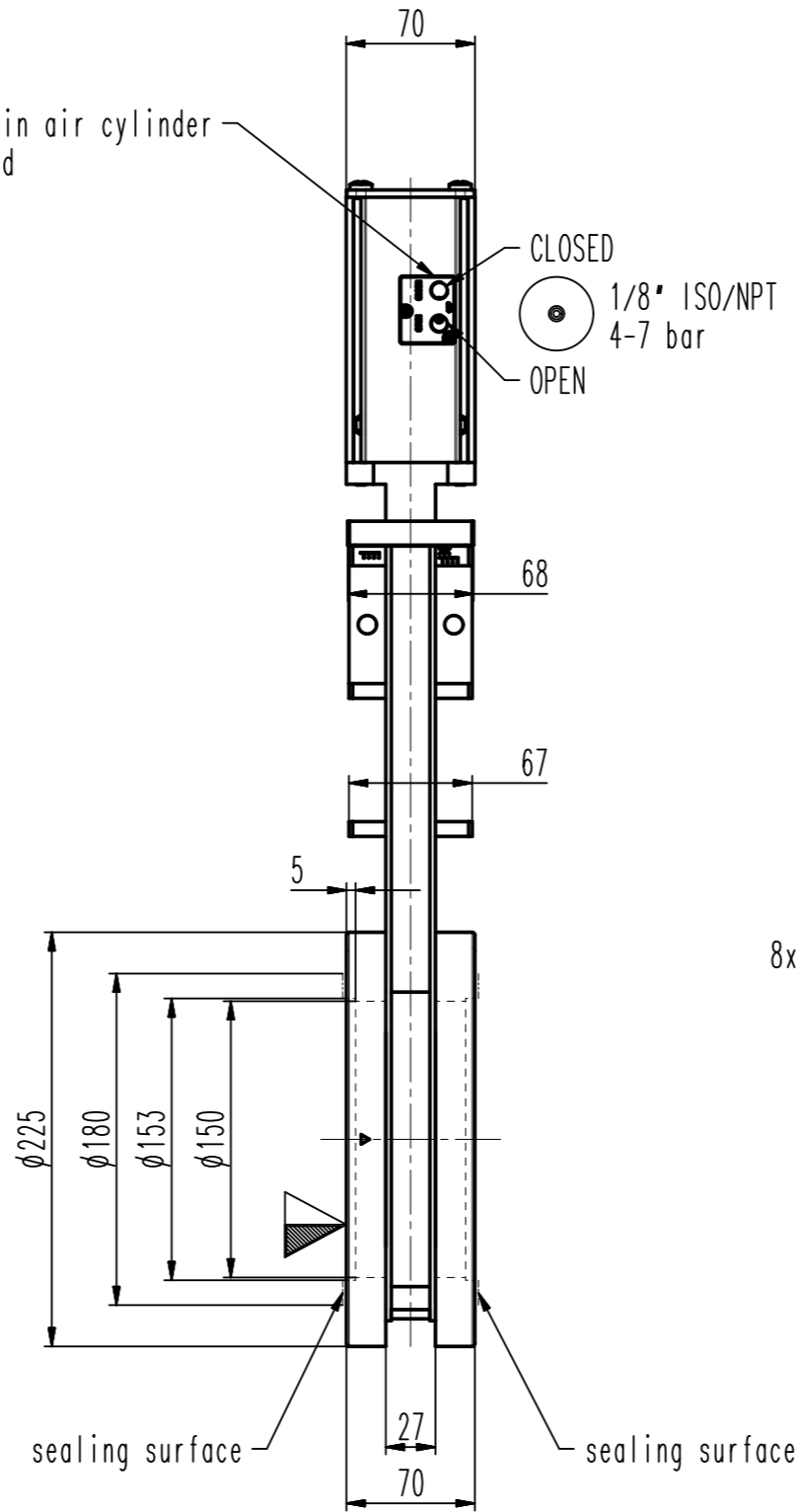

VAT Vakuumventile AG
 CH-9469 Haag, Switzerland
 Tel ++41 81 7716161 Fax ++41 81 7714830

Rev.-Date: 17.08.99
 Visa: SUP

Series	108	Ordering No.	10844-PE24-0005
Projection E	DN	Flange	ISO-F
	160		
Dimensional Drawing	207700	Rev.	