

This drawing is the property of VAT.

Revision

Customer number

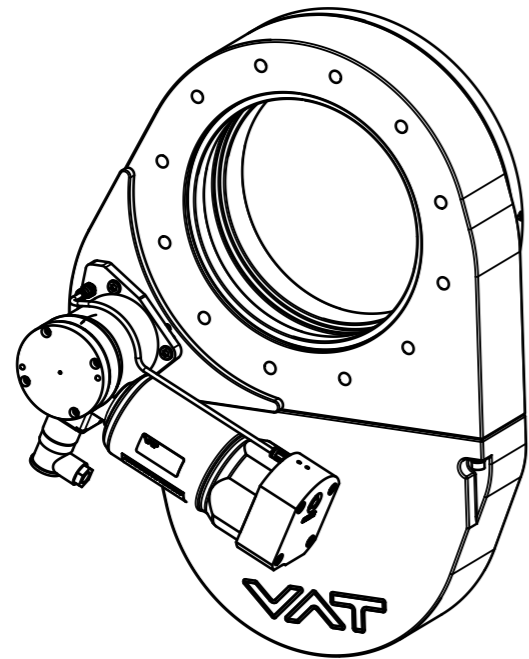
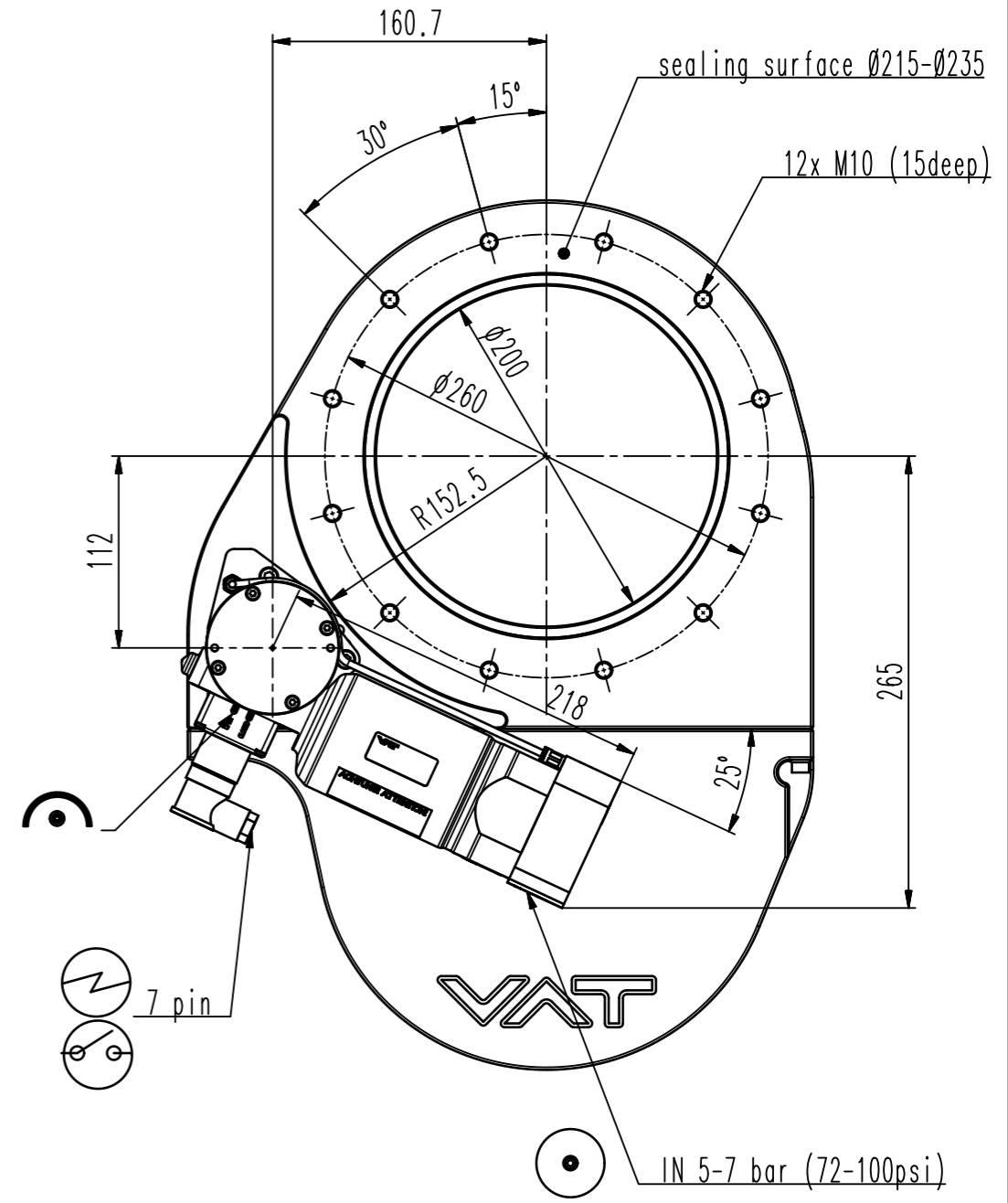
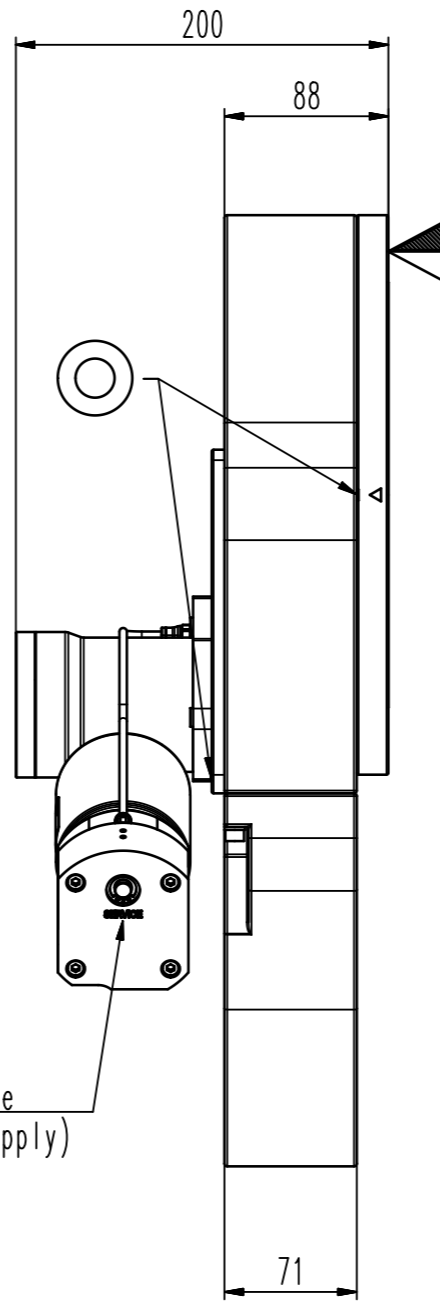
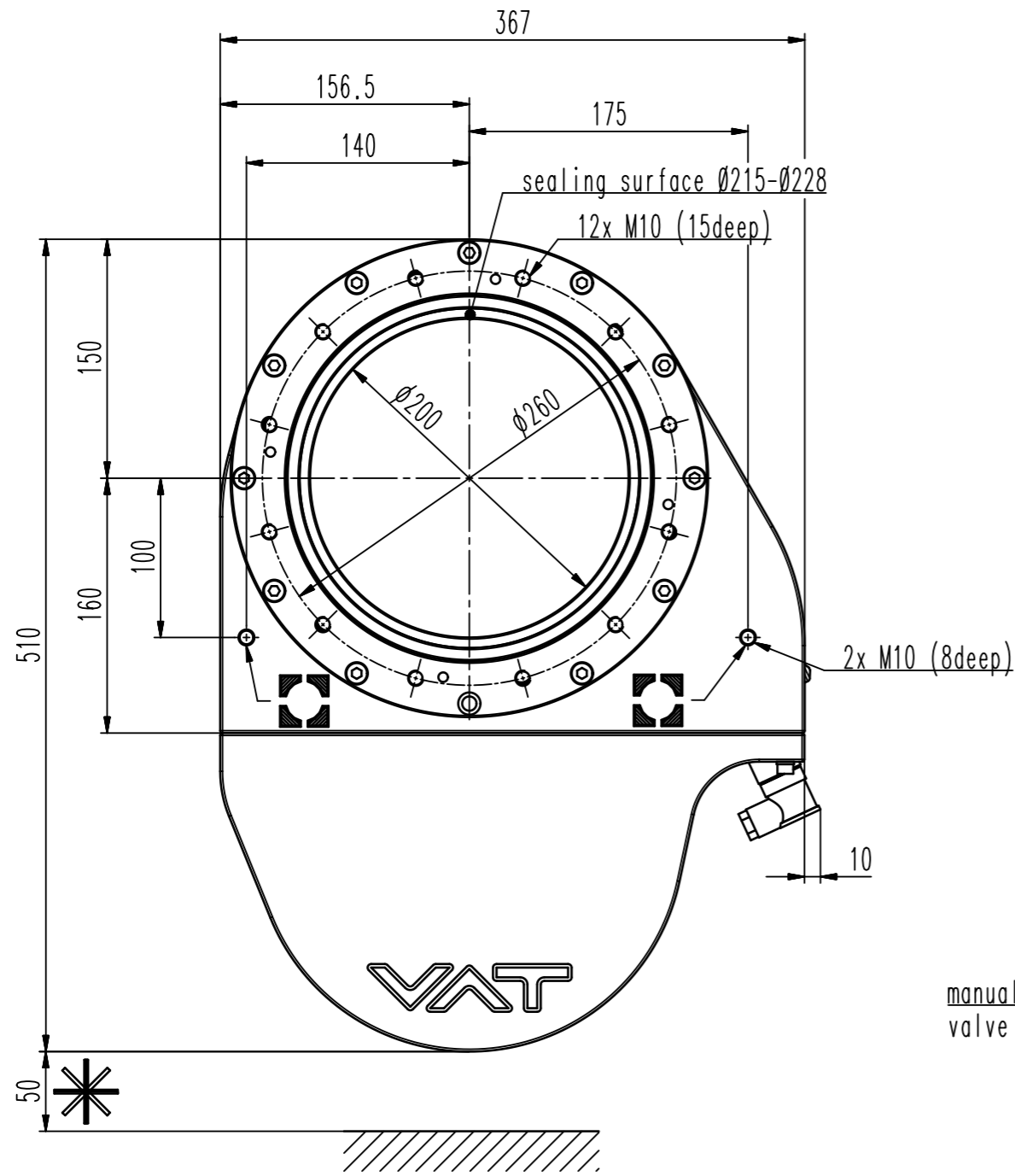

- ▼ Seat side
- ⊙ Comp. air connection
- ⊙ Electrical connection
- ⊙ Leak detection port
- ⊙ Mech. pos. indication
- ⊙ Position indicator
- ⊙ Required for dismantling
- ⊙ Emergency actuation
- ⊙ For attachment
- ⊙ Bake-out area
- ⊙ Differential pumping port

Pendulum valve



VAT Vakuumentile AG
CH-9469 Haag, Switzerland
Tel ++41 81 7716161 Fax ++41 81 7714830

Date: 16.12.02
Name: TRM

Series	162	Ordering No.	16246-PA21-0001
Projection E	DN	Flange	ISO-F
	200		
Dimensional Drawing	235313	Rev.	E