

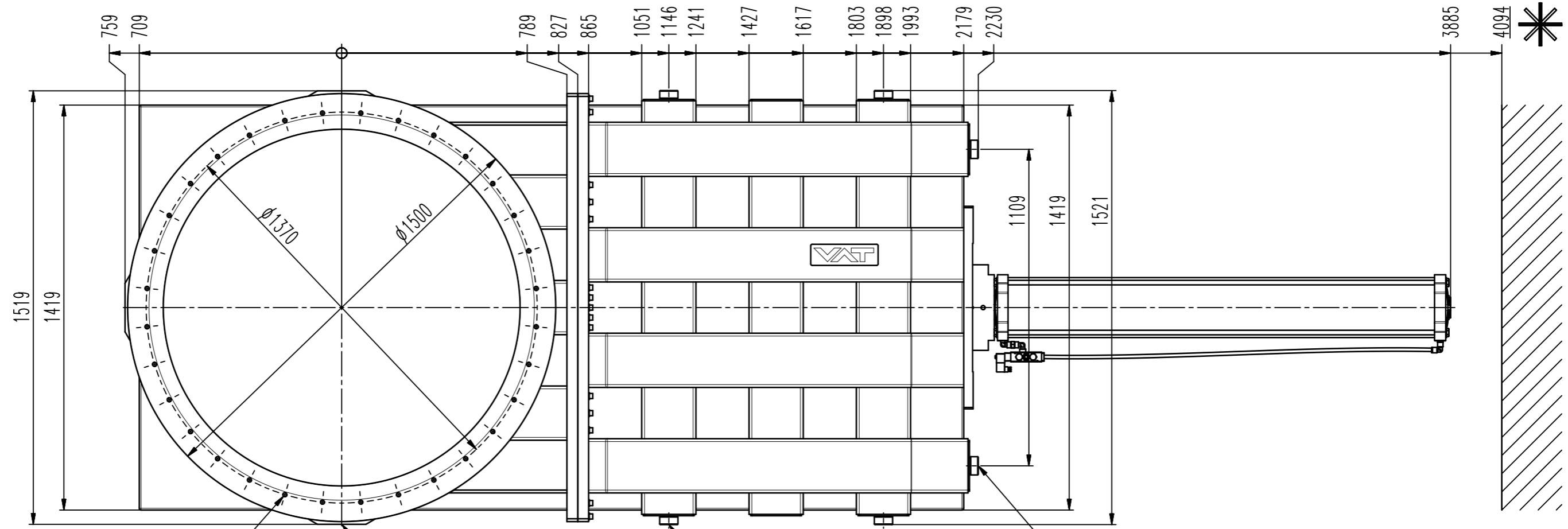

This drawing is the property of VAT.

Revision

Customer number

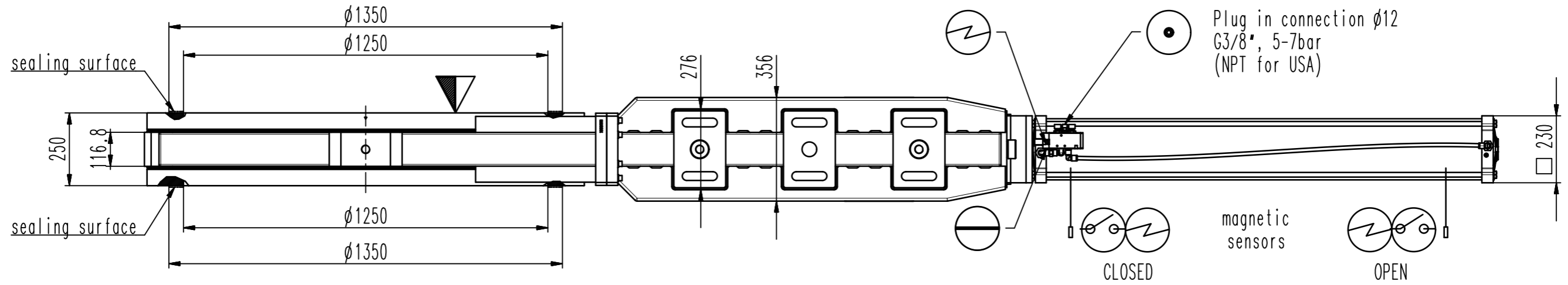









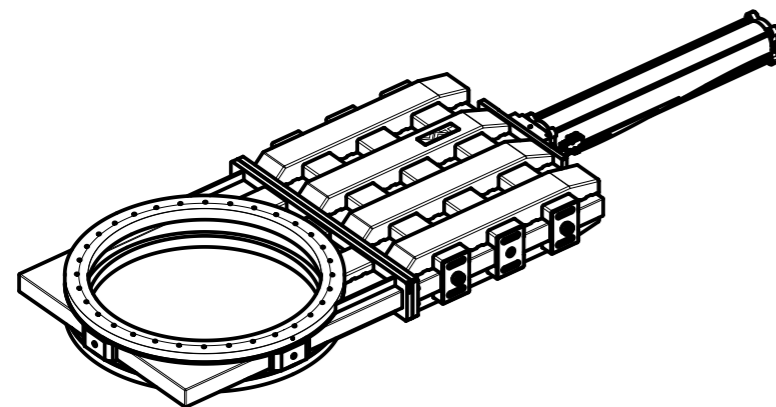

32xM16, 25deep

 M30 - 45 deep (3x)  
Lifting point suitable for  
Load Ring

 M30 - 45 deep (4x)  
Lifting point suitable for  
Load Ring

 Load Ring (2x)  
M30



-  Seat side
-  Comp. air connection
-  Electrical connection
-  Leak detection port
-  Mech. pos. indication
-  Position indicator
-  Required for dismantling
-  Emergency actuation
-  For attachment
-  Bake-out area
-  Differential pumping port

## Large gate valves



VAT Vakuumventile AG

CH-9469 Haag, Switzerland  
Tel ++41 81 7716161 Fax ++41 81 7714830

Rev.-Date: 22.05.17

Visa: BEST

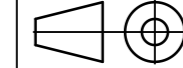
Series	190	Ordering No.	19062-PE44-0004
Projection E	DN	Flange	
	1250	ISO-F	
Dimensional Drawing	895751	Rev.	