

## Vatterfly valve with pneumatic actuator

This manual is valid for the valve ordering number(s):

203 . . .

204 . . .

The fabrication number is indicated on each product as per the label below (or similar):

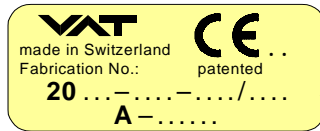

← Fabrication number



Explanation of symbols:



Read declaration carefully before you start any other action!



Keep body parts and objects away from the valve opening!



Attention!



Hot surfaces; do not touch!



Product is in conformity with EC guidelines, if applicable!



Loaded springs and/or air cushions are potential hazards!



Disconnect electrical power and compressed air lines. Do not touch parts under voltage!



Wear gloves!



Read these «**Installation, Operating & Maintenance Instructions**» and the enclosed «**General Safety Instructions**» carefully before you start any other action!



**Imprint:**

**Manufacturer** VAT Vakuumventile AG, CH-9469 Haag, Switzerland

Website  
www.vatvalve.com

Phone  
+41 81 771 61 61

Fax  
+41 81 771 48 30

Email  
CH@vatvalve.com

**Publisher** VAT Vakuumventile AG, CH-9469 Haag, Switzerland

**Editor** VAT Vakuumventile AG, CH-9469 Haag, Switzerland

**Print** VAT Vakuumventile AG, CH-9469 Haag, Switzerland

**Copyright** © VAT Vakuumventile AG 2008

No part of these Instructions may be reproduced in any way (photocopies, microfilms or any other reproduction processes) nor may it be manipulated with electronic systems, duplicated or distributed without written permission from VAT. Offenders are liable to pay damages.

The original VAT firmware and updated state of the art versions of the VAT firmware are intended for use with VAT products. The VAT firmware contains a limited, time unlimited user license. The VAT firmware may not be used for purposes other than those intended nor is it permitted to make copies of the VAT firmware. In particular, it is strictly forbidden to give copies of the VAT firmware to other people.

The use of trade names, brand names, trademarks, etc. in these Instructions does not entitle third parties to consider these names to be unprotected and to use them freely. This is in accordance with the meaning of the laws and acts covering brand names and trademarks.



**Contents:**

|       |   |    |
|-------|---|----|
| 1     | Use of product .....                                    | 4  |
| 1.1   | Technical data .....                                    | 4  |
| 2     | Installation .....                                      | 5  |
| 2.1   | Installation into the system .....                      | 5  |
| 2.2   | Connections .....                                       | 5  |
| 2.2.1 | Compressed air connection .....                         | 5  |
| 2.2.2 | Electrical connection .....                             | 5  |
| 3     | Operation .....   | 6  |
| 3.1   | Normal operation .....                                  | 6  |
| 3.2   | Operation under increased temperature .....             | 6  |
| 3.3   | Behavior in case of compressed air pressure drop .....  | 6  |
| 3.4   | Behavior in case of power failure .....                 | 6  |
| 4     | Trouble shooting .....                                  | 6  |
| 5     | Maintenance & repairs .....                             | 7  |
| 5.1   | Replacement of plate seal (1) .....                     | 7  |
| 5.1.1 | Dismount plate from valve .....                         | 7  |
| 5.1.2 | Replace plate seal (1) .....                            | 8  |
| 5.1.3 | Mount plate to valve .....                              | 8  |
| 5.2   | Replacement of solenoid (4) .....                       | 8  |
| 5.3   | Replacement of position indicator (7) .....             | 9  |
| 5.4   | Replacement of bonnet seal/feedthrough O-ring (9) ..... | 9  |
| 6     | Drawing .....   | 10 |
| 7     | Spare parts .....                                       | 11 |
| 8     | Warranty .....  | 11 |



## 2 Installation

### 2.1 Installation into the system



Use standard ISO centering rings only for installing ISO flanges!

The centering rings must fit well into the centering groove. Any clearance is prohibited. Too thick or improperly centered rings can cause the plate to touch the centering ring if the plate is in open position. This would damage the plate seal or interfere with the plate movement!

### 2.2 Connections

#### 2.2.1 Compressed air connection



Compressed air may only be connected by an authorized expert!

Connect compressed air only when - valve is installed into the system  
- moving parts cannot be touched

Compressed air connection:

- Internal thread M5 (1/8" optional) with valves without solenoid → (open/close)
- Internal thread 1/8" with valves with solenoid → (IN at the solenoid)

Compressed air pressure (min. - max. overpressure): 4 - 7 bar / 60 - 100 psi

Use clean, dry or slightly oiled air only!

#### 2.2.2 Electrical connection



Electrical power may only be connected by an authorized expert!

Do not touch parts under voltage!



Connect electrical power only when  
- valve is installed into the system  
- moving parts cannot be touched

Verify that the control voltage is in accordance with the voltage stated on the solenoid!  
See (4) on drawing page 10

Plug for position indicator and solenoid are supplied with the valve.

Connection of position indicator plug:

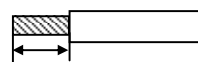

5 - 6 mm

unisolate

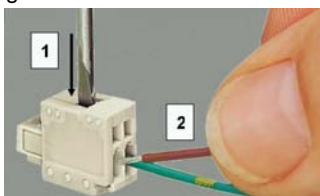

connection

1 press to open the clamp  
2 insert the cable to the plug



strain relief

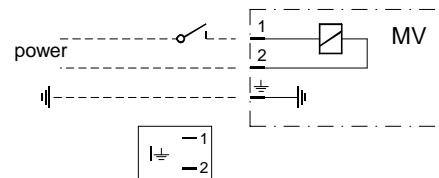

MV = coil of solenoid

Plug (5) on drawing page 10



### 3 Operation

#### 3.1 Normal operation

Valve is pneumatically opened and closed (double acting compressed air cylinder).

Compressed air pressure: see «2.2.1 Compressed air connection »

Voltage: according to specification on solenoid: see (4) on drawing page 10

#### 3.2 Operation under increased temperature

See «1.1 Technical data»

#### 3.3 Behavior in case of compressed air pressure drop

| Valve position               | Reaction of valve           |
|------------------------------|-----------------------------|
| closed                       | remains closed              |
| open                         | remains open                |
| in any intermediate position | plate movement is undefined |

#### 3.4 Behavior in case of power failure

| Valve                  | Reaction of valve                  |
|------------------------|------------------------------------|
| supplied with solenoid | closes                             |
| without solenoid       | dependent on pneumatics connection |

### 4 Trouble shooting

| Failure                       | Check                                | Action   |
|-------------------------------|--------------------------------------|--|
| Valve cannot be opened/closed | Correct control voltage on solenoid? | Apply correct voltage  |
|                               | Appropriate compressed air pressure? | Apply compressed air pressure according to «2.2.1 Compressed air connection» |
|                               | Solenoid defective?                  | Replace solenoid   |
| No position indication        | Position indicator defective?        | Replace position indicator   |
| Valve does not close tight    | Obstacle in the plate rotation area? | Clear plate rotation area  |
|                               | Valve seat or seal contaminated?     | Clean valve seat and seal  |

If you need any further information, please contact one of our service centers. You can find the addresses on our website: <http://www.vat.ch>

## 5 Maintenance & repairs

Under clean operating conditions, the valve does not require any maintenance during the specified cycle life. Contamination from the process may influence the function and requires more frequent maintenance.

Before carrying out any maintenance or repairs, please contact VAT. It has to be individually decided whether the maintenance/repair can be performed by the customer or has to be carried out by VAT. The fabrication number on the valve

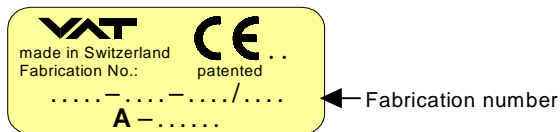

has always to be specified.

All supplies (e. g. compressed air, electrical power) must be disconnected for removal/installation of the valve from/into the system and for maintenance work.



Even with disconnected supply, loaded springs and/or air cushions in cylinders can be potential hazards.



Keep fingers and objects away from the valve opening!

Products returned to VAT must be free of harmful substances such as e.g. toxic, caustic or microbiological ones. If products are radioactively contaminated, fill in the VAT form «Contamination and Radiation Report» and send it with the product. The form is available at VAT. The maximum values indicated in the form must not be exceeded.

### 5.1 Replacement of plate seal (1)

The item numbers in brackets refer to the drawing on page 10

Valve must be removed from the system!

#### 5.1.1 Dismount plate from valve



- Fasten valve in vertical position in a vise with soft braces (see picture)  
**Attention:** Do not damage the sealing surface inside the bolt circle!

- If valve is provided with a solenoid, dismount it:  
Remove 2 screws (6) and solenoid (4)

- Loosen screw (3), but do not unscrew it



- Open valve:  
Keep any objects/body parts away from the plate moving area and feed compressed air into the inlet «OPEN»; recommended pressure 2 bar



- Remove screw (3) and plate (2)  
**Attention:** Between plate (2) and shaft are sometimes adjustment washers installed, which have to be reinstalled after the maintenance!

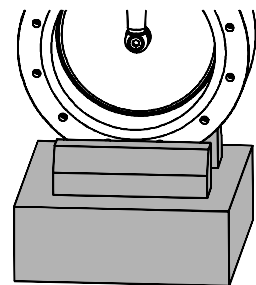

### 5.1.2 Replace plate seal (1)

- Stick a needle into the O-ring (1) and pull it out  
**Attention:** Do not damage the sealing surface!
- Remove support ring (11)
- Clean sealing surface and support ring (11)
- Insert support ring (11)
- Put new O-ring (1) on groove and press it first into groove at 4 points displaced by 90° (see picture)
- Then press O-ring completely and uniformly into groove



### 5.1.3 Mount plate to valve



- Insert plate (2)
- Insert screw (3) completely, but do not fasten it  
**Attention:** Between plate (2) and shaft the adjustment washers, which may have been dismantled when the plate was dismantled, have to be reinstalled!



- Close valve:  
Keep any objects/body parts away from the plate moving area and feed compressed air into the inlet «CLOSE»; recommended pressure 2 bar
- Fasten screw (3)  
torque: 

|         |     |    |     |     |     |
|---------|-----|----|-----|-----|-----|
| DN [mm] | 63  | 80 | 100 | 160 | 200 |
| [Nm]    | 3.5 | 6  | 8   | 15  | 30  |
- Mount solenoid (4)

## 5.2 Replacement of solenoid (4)

The item numbers in brackets refer to the drawing on page 10



- Switch off compressed air
- Disconnect compressed air line
- Switch off electrical power
- Remove plug (5) from solenoid
- Remove 2 screws (6) and solenoid (4)
- Clean sealing surface, if necessary
- Mount new solenoid (4) to valve  
**Attention:** Make sure that voltage is correct!
- Connect plug (5) to solenoid (4)
- Connect compressed air
- Switch on electrical power



### 5.3 Replacement of position indicator (7)

The item numbers in brackets refer to the drawing on page 10



- Switch off electrical power
- Remove plug from position indicator (7)
- Remove screws (8)
- Remove position indicator (7)
- Fasten new position indicator (7) by the screws (8)
- Connect plug to position indicator (7)
- Switch on electrical power

### 5.4 Replacement of bonnet seal/feedthrough O-ring (9)

The item numbers in brackets refer to the drawing on page 10

Valve must be removed from the system!

- Dismount plate from valve according to «5.1.1 Dismount plate from valve»
- Remove both screws (10)
- Vertically withdraw actuator with shaft
- Remove O-ring (9)
- Clean sealing surfaces on body and shaft
- Put grease layer on shaft (see picture)
- Lubricate new O-ring (9) with plenty of vacuum grease (see «7 Spare parts») and insert it
- Insert actuator with shaft
- Insert both screws (10) and fasten them alternately step-by-step
- Mount plate to valve according to «5.1.3 Mount plate to valve»



## 6 Drawing

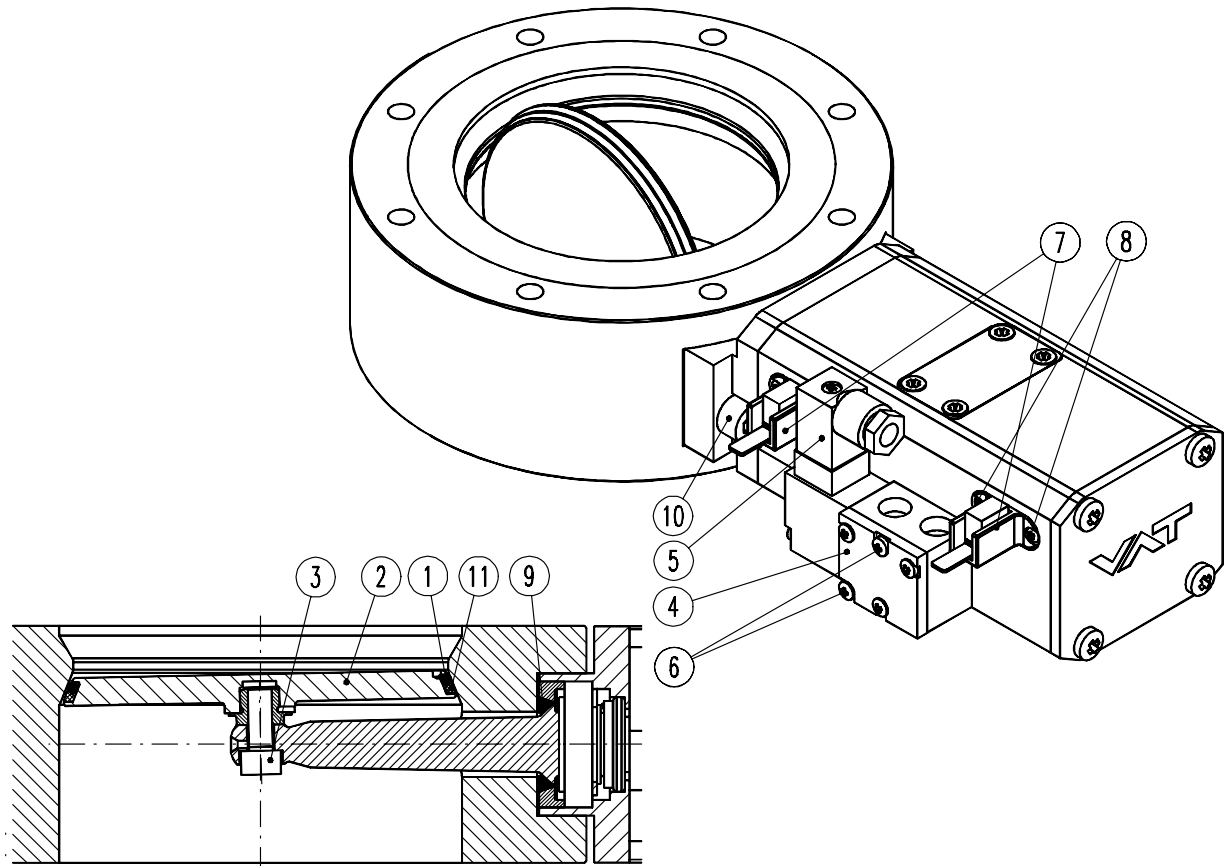



## 7 Spare parts

The item numbers in brackets refer to the drawing on page 10

| Item | Quantity<br>for 1 valve | Designation   | DN       | Ordering No. |
|------|-------------------------|---|----------|--------------|
| 7    | 2                       | Position indicator kit (only one piece)                                   | 63 - 200 | 226699       |
| 4    | 1                       | Solenoid (specify voltage!)   | 63 - 200 | 94800-R1     |
|      | 1                       | Seal kit vacuum, consisting of item 1 + 9<br>according to drawing page 10 | 63       | 230648       |
|      |                         |   | 80       | 230649       |
|      |                         |   | 100      | 230650       |
|      |                         |   | 160      | 230651       |
|      |                         |   | 200      | 230652       |
| 11   | 1                       | Support ring  | 63       | 234138       |
|      |                         |   | 80       | 233264       |
|      |                         |   | 100      | 233010       |
|      |                         |   | 160      | 233395       |
|      |                         |   | 200      | 234139       |
|      | 1                       | Vacuum grease for feedthrough O-ring                                      | 63 - 200 | N-6951-01    |

## 8 Warranty

Each product sold by VAT Vakuumentile AG (VAT) is warranted to be free from the manufacturing defects that adversely affect the normal functioning thereof during the warranty period stated in VAT's «Terms of Sale» immediately following delivery thereof by VAT, provided that the same is properly operated under conditions of normal use and that regular, periodic maintenance and service is performed or replacements made, in accordance with the instructions provided by VAT. The foregoing warranty shall not apply to any product or component that has been repaired or altered by anyone other than an authorized VAT representative or that has been subject to improper installation or abuse, misuse, negligence or accident. VAT shall not be liable for any damage, loss, or expense, whether consequential, special, incidental, direct or otherwise, caused by, arising out of or connected with the manufacture, delivery (including any delay in or failure to deliver), packaging, storage or use of any product sold or delivered by VAT shall fail to conform to the foregoing warranty or to the description thereof contained herein, the purchaser thereof, as its exclusive remedy, shall upon prompt notice to VAT of any such defect or failure and upon the return of the product, part or component in question to VAT at its factory, with transportation charges prepaid, and upon VAT's inspection confirming the existence of any defect inconsistent with said warranty or any such failure, be entitled to have such defect or failure cured at VAT's factory and at no charge therefor, by replacement or repair of said product, as VAT may elect. VAT MAKES NO WARRANTY OR REPRESENTATION OF ANY KIND, EXPRESS OR IMPLIED, (INCLUDING NO WARRANTY OR MERCHANTABILITY), EXCEPT FOR THE FOREGOING WARRANTY AND THE WARRANTY THAT EACH PRODUCT SHALL CONFORM TO THE DESCRIPTION THEREOF CONTAINED HEREIN, and no warranty shall be implied by law.

Furthermore, the «Terms of sale» at the back of the price list are applicable.