

This drawing is the property of VAT.  
Without the written consent of VAT, it must  
not be copied or distributed to a third person

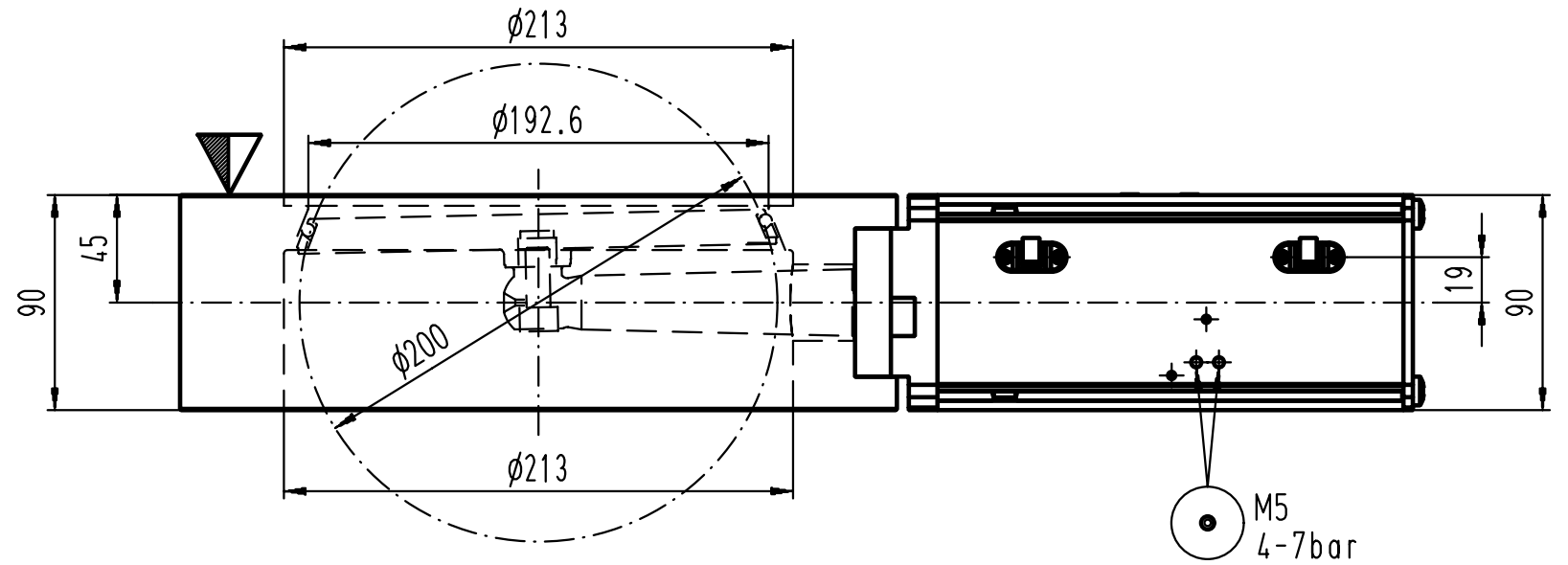

**SECTION A-A:**

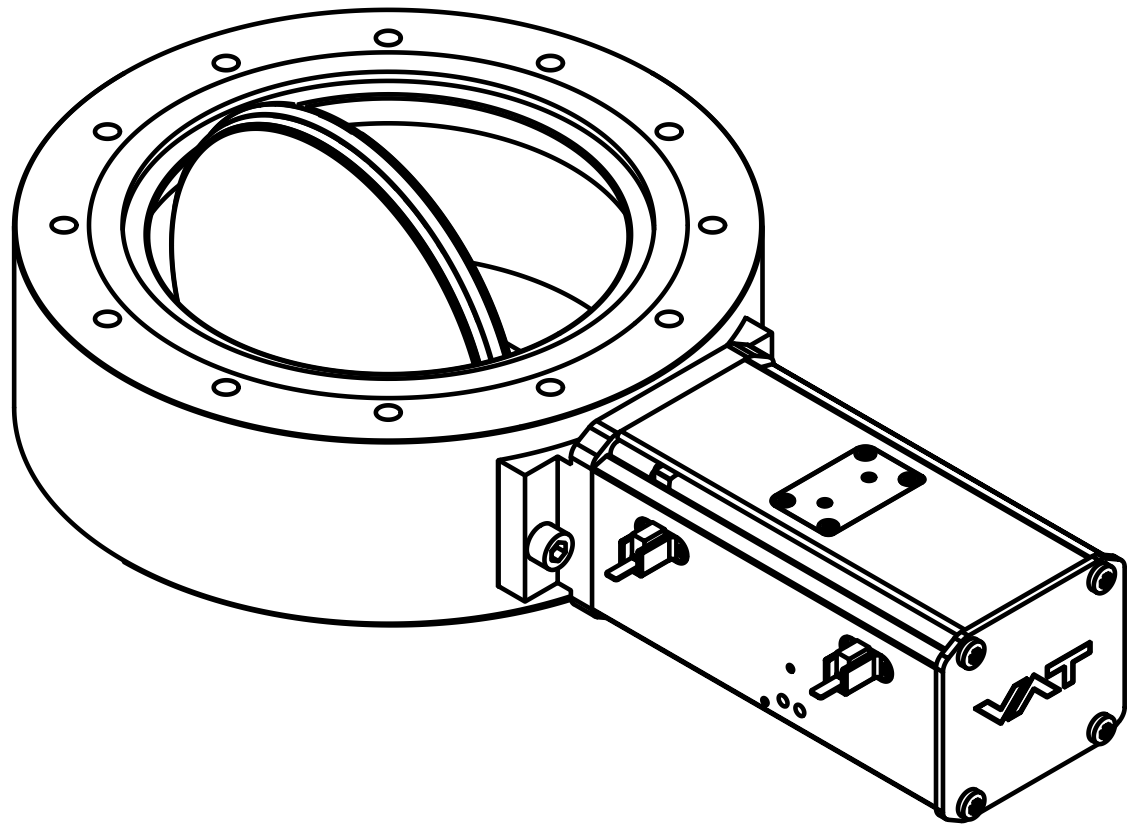
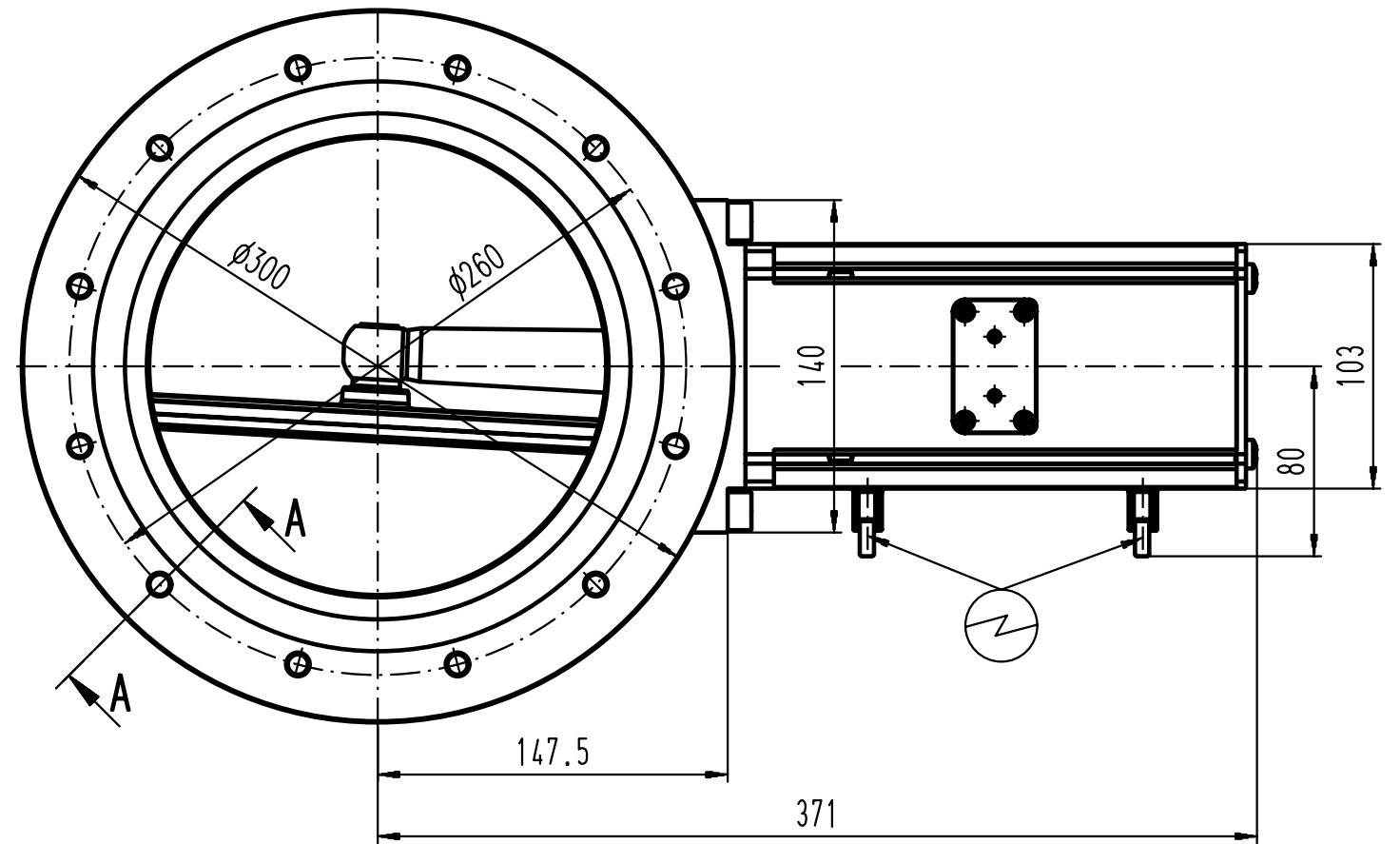
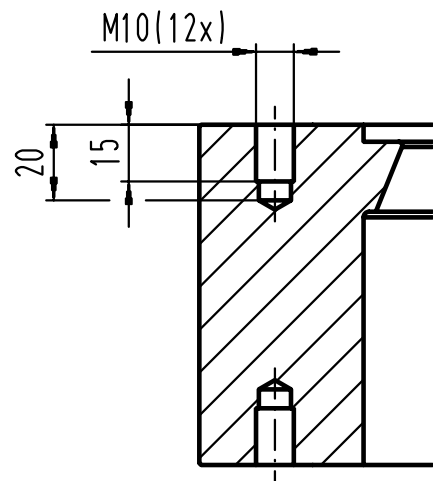

Revision			
Code			
Date			
Name			

- ▼ Seat side
- ⊙ Comp. air connection
- ⊕ Electrical connection
- ⊖ Leak detection port
- ⊗ Mech. pos. indication
- ⊘ Position indicator
- ⊙\* Required for dismantling
- ⊙ Emergency actuation
- ⊙ For attachment
- ⊙ Bake-out area
- ⊙ Differential pumping port

**Vatterfly Valve**  
pneumatic actuator



**VAT Vakuumventile AG**  
CH-9469 Haag, Switzerland  
Tel ++41 81 7716161 Fax ++41 81 7714830

Date: 22.11.02  
Name: KIM

Series	20.3	Ordering No.	20346-PA24
Projection E		DN	200
		Flange	ISO-F
Dimensional Drawing	234549	Rev.	