

This drawing is the property of VAT.

Revision

Customer number

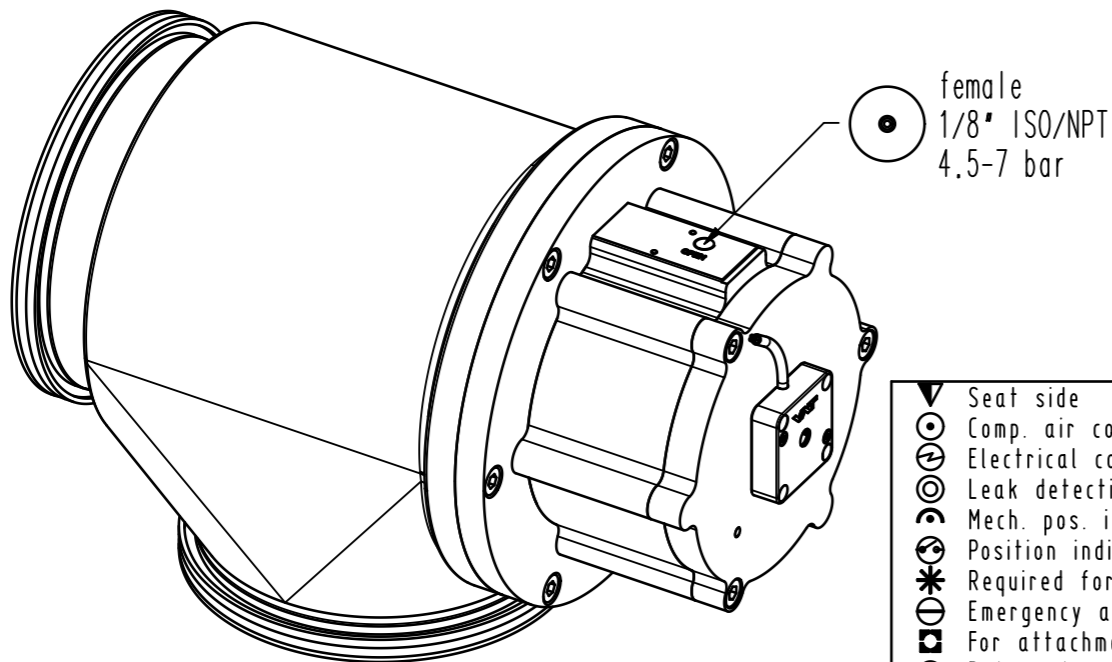
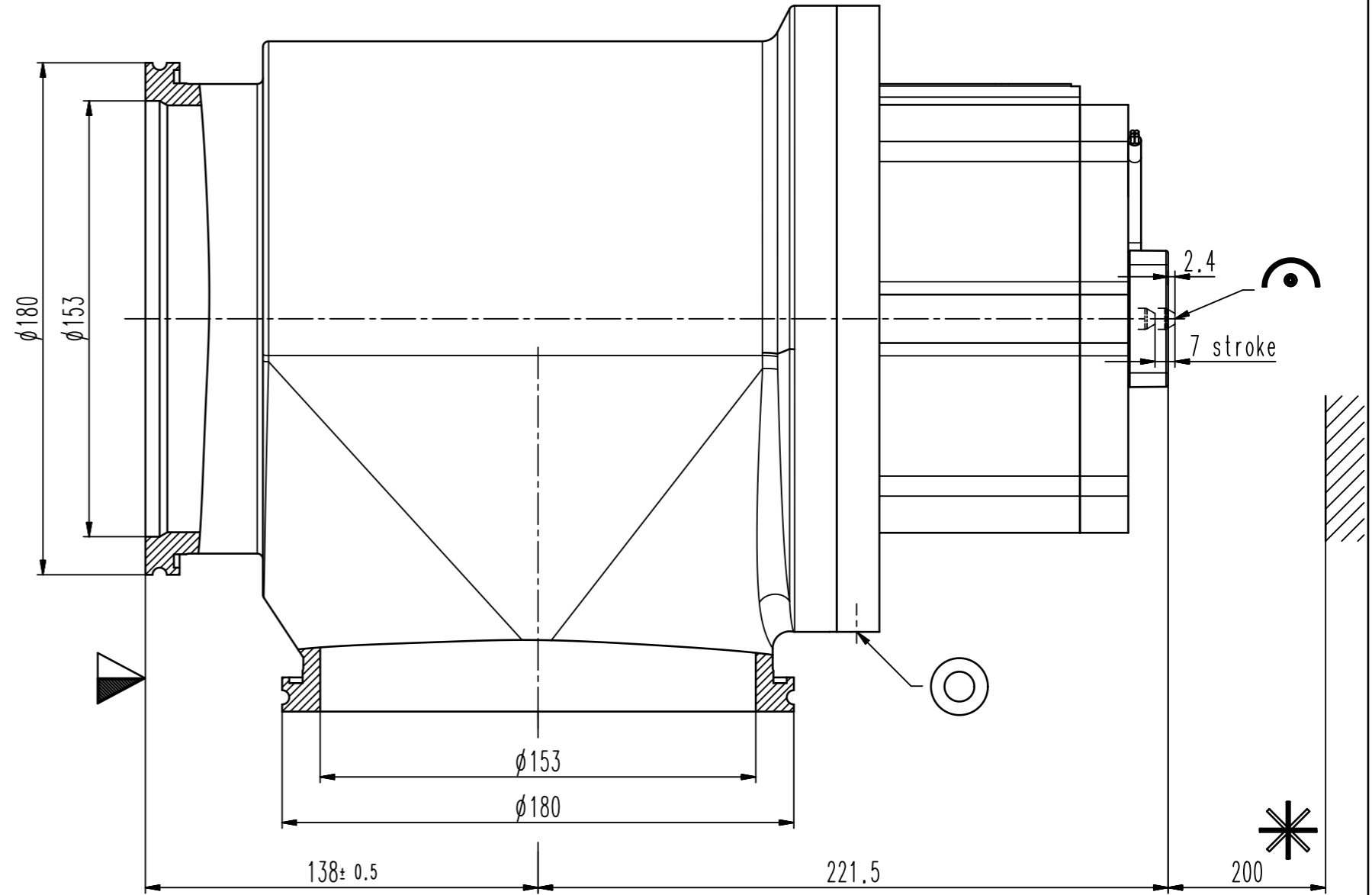
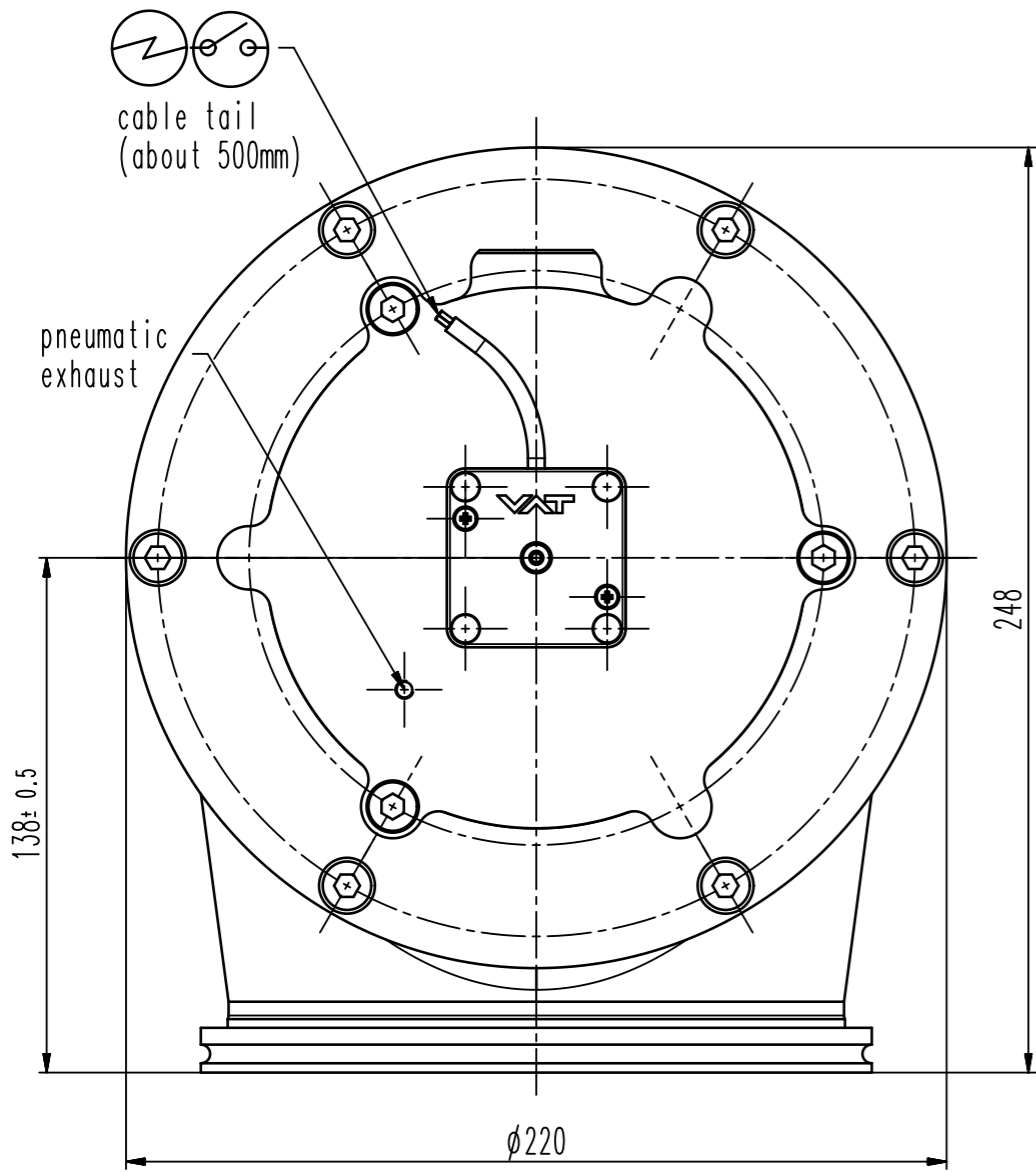

- ▼ Seat side
- ⊙ Comp. air connection
- ⊙ Electrical connection
- ⊙ Leak detection port
- ⊙ Mech. pos. indication
- ⊙ Position indicator
- ⊙ Required for dismantling
- ⊙ Emergency actuation
- ⊙ For attachment
- ⊙ Bake-out area
- ⊙ Differential pumping port

Vacuum angle valve



VAT Vakuumventile AG

CH-9469 Haag, Switzerland
Tel ++41 81 7716161 Fax ++41 81 7714830

Rev.-Date: 02.02.15

Visa: SLU

Series	244	Ordering No.	24444-QA21-0001
Projection E	DN	Flange	ISO-K
	160		
Dimensional Drawing	563809	Rev.	A