

Installation, Operating & Maintenance Instructions



Vacuum angle valve with double acting pneumatic actuator

Series 244
DN 200–1000 mm (I. D. 8” – 40”)

This manual is valid for the following product ordering numbers:
244 .. - -

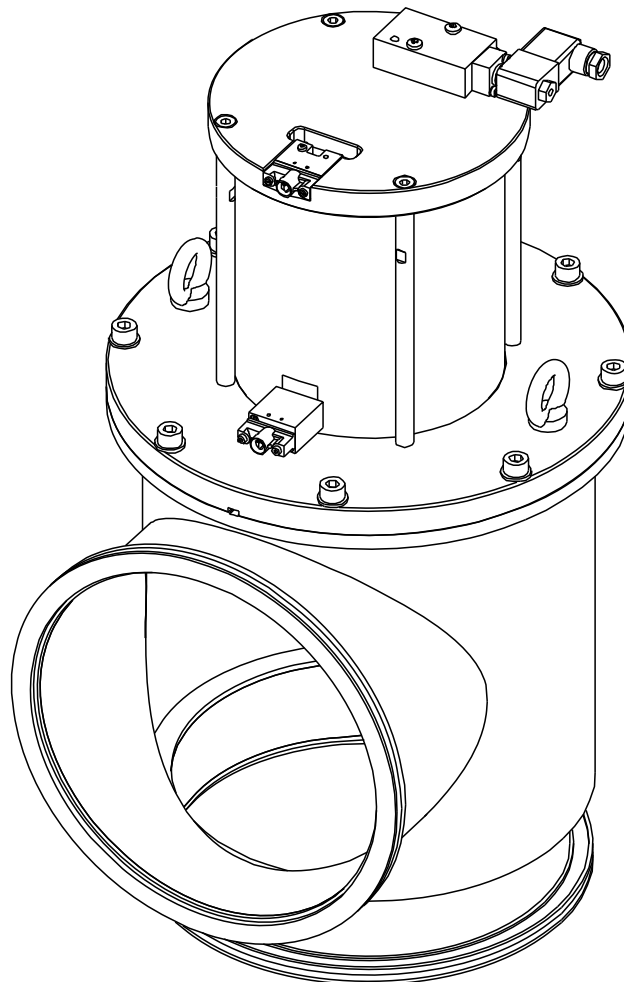

Sample picture

Imprint

Manufacturer VAT Vakuumventile AG, CH-9469 Haag, Switzerland

Website: www.vatvalve.com

Phone: +41 81 771 61 61

Fax: +41 81 771 48 30

Email: CH@vatvalve.com

Publisher VAT Vakuumventile AG, CH-9469 Haag, Switzerland

Editor VAT Vakuumventile AG, CH-9469 Haag, Switzerland

Print VAT Vakuumventile AG, CH-9469 Haag, Switzerland

Copyright © VAT Vakuumventile AG 2015

No part of these instructions may be reproduced in any way (photocopies, microfilms or any other reproduction processes) nor may it be manipulated with electronic systems, duplicated or distributed without written permission from VAT. Offenders are liable to pay damages.

The original VAT firmware and updated state of the art versions of the VAT firmware are intended for use with VAT products. The VAT firmware contains a limited, time unlimited user license. The VAT firmware may not be used for purposes other than those intended nor is it permitted to make copies of the VAT firmware. In particular, it is strictly forbidden to give copies of the VAT firmware to other people.

The use of trade names, brand names, trademarks, etc. in these Instructions does not entitle third parties to consider these names to be unprotected and to use them freely. This is in accordance with the meaning of the laws and acts covering brand names and trademarks.

Contents

1	Description of product.....	5
1.1	Identification of product.....	5
1.2	Use of product.....	5
1.3	Related documents	5
1.4	Important information	5
1.5	Technical data.....	5
2	Safety	6
2.1	Compulsory reading material	6
2.2	Danger levels	6
2.3	Personnel qualifications	7
2.4	Safety labels.....	7
3	Design and Function.....	8
3.1	Design	8
3.2	Function	8
4	Installation	9
4.1	Unpacking	9
4.2	Installation into the system.....	11
4.2.1	Admissible forces and bending moments	11
4.3	Compressed air connection	12
4.4	Electrical connection	12
5	Operation	13
5.1	Normal operation.....	13
5.2	Operation under increased temperature.....	13
5.3	Behavior in case of compressed air pressure drop	13
5.4	Behavior in case of power failure.....	13
5.5	Trouble shooting	13
6	Maintenance	14
6.1	Maintenance intervals	15
6.2	Required tools	15
6.3	Replacement of vacuum seals.....	15
6.3.1	Dismount actuator / plate assembly.....	15
6.3.2	Replacement of plate seal	16
6.3.3	Mount actuator / plate assembly.....	16
6.4	Replacement of shaft feedthrough seal and pneumatic seals.....	16
7	Repairs	18
8	Dismounting and Storage.....	19
8.1	Dismounting	20
8.2	Storage.....	20
9	Packaging and Transport	21
9.1	Packaging	22
9.2	Transport.....	22

10	Disposal.....	23
11	Spare parts.....	24

1 Description of product

1.1 Identification of product

The fabrication number and order number are fixed on the product directly or by means of an identification plate.

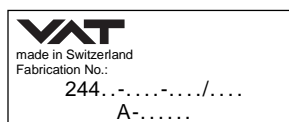

← Fabrication number

← Order number

1.2 Use of product

Use product for clean and dry vacuum applications only. Other applications are only allowed with the written permission of VAT.

1.3 Related documents

- Product data sheet
- Dimensional drawing

1.4 Important information



This symbol points to a very important statement that requires particular attention.

Example:



VAT disclaims any liability for damages resulting from inappropriate packaging.

1.5 Technical data

See product data sheet and dimensional drawing.

2 Safety

2.1 Compulsory reading material

Read this chapter prior to performing any work with or on the product. It contains important information that is significant for your own personal safety. This chapter must have been read and understood by all persons who perform any kind of work with or on the product during any stage of its serviceable life.

	NOTICE
	<p>Lack of knowledge Failing to read this manual may result in property damage. Firstly, read manual.</p>

These Installation, Operating & Maintenance Instructions are an integral part of a comprehensive documentation belonging to a complete technical system. They must be stored together with the other documentation and accessible for anybody who is authorized to work with the system at any time.

2.2 Danger levels



	⚠ DANGER
	<p>High risk Indicates a hazardous situation which, if not avoided, will result in death or serious injury.</p>

	⚠ WARNING
	<p>Medium risk Indicates a hazardous situation which, if not avoided, could result in death or serious injury.</p>

	⚠ CAUTION
	<p>Low risk Indicates a hazardous situation which, if not avoided, may result in minor or moderate injury.</p>

	NOTICE
	<p>Command Indicates a hazardous situation which, if not avoided, may result in property damage.</p>

2.3 Personnel qualifications

	 WARNING
	<p>Unqualified personnel Inappropriate handling may cause serious injury or property damage. Only qualified personnel are allowed to carry out the described work.</p>

2.4 Safety labels

Label	Part No.	Location on valve
	T-9001-155	On protective foil covering the valve opening

Table 2-1

3 Design and Function

3.1 Design

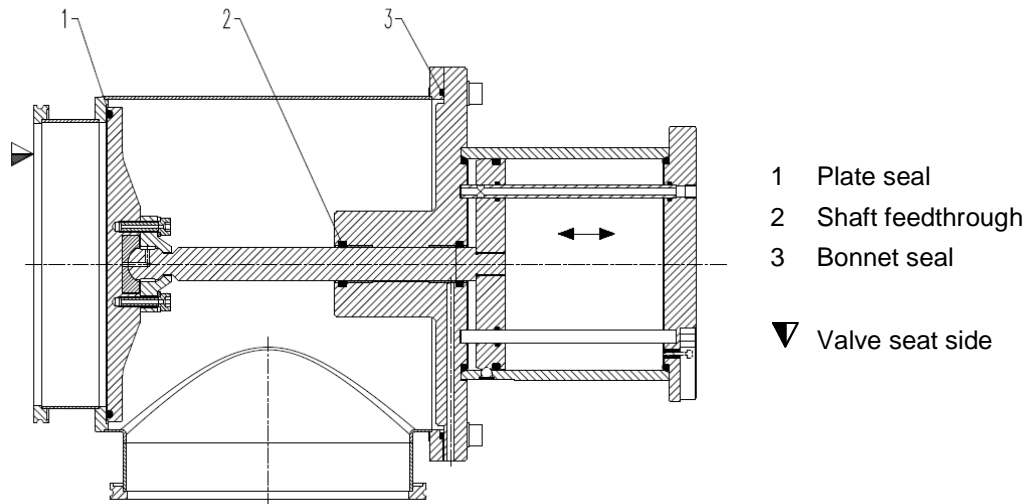



Figure 3-1

100%Zuhn

3.2 Function

Valve opens and closes pneumatically.

4 Installation

	⚠ WARNING
	Unqualified personnel Inappropriate handling may cause serious injury or property damage. Only qualified personnel are allowed to carry out the described work.

	⚠ WARNING
	Heavy weight Physical overstraining. Use a crane to lift the product.

4.1 Unpacking



- Make sure that the supplied products are in accordance with your order.
- Inspect the quality of the supplied products visually. If it does not meet your requirements, please contact VAT immediately.
- Store the original packaging material. It may be useful if products must be returned to VAT.



The protective covers may only be removed immediately before the valve is mounted into the system. Unprotected sealing surfaces must be treated with care and keep clean.



The valve can be lifted only at the eyebolts; see dimensional drawing.



NOTICE	
	<p>Sensitive product Product will get damaged if not handled carefully. Handle product with care: Do not touch solid objects when lifting the product.</p>

1. Lift valve carefully with lifting ropes at the two eyebolts (1); see «Figure 4-1». Weight of product, see product data sheet.



Put it down on a clean surface or mount it to a clean system.

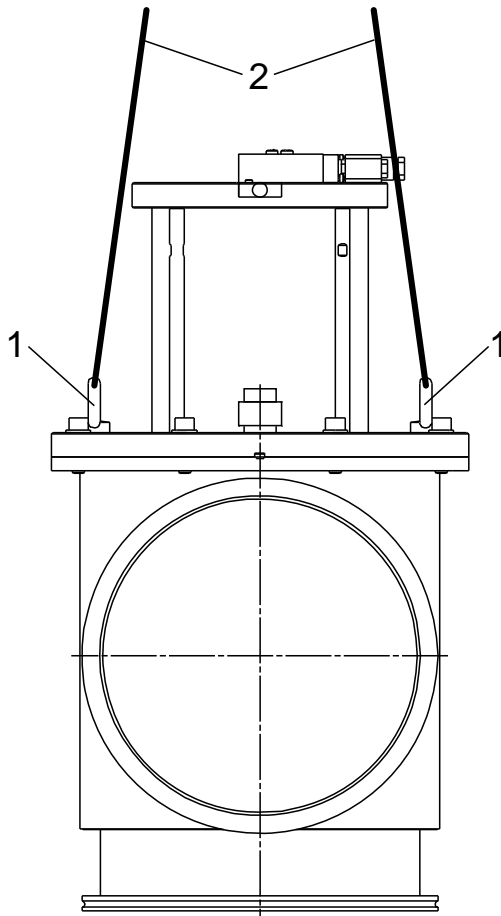



- 1 Eyebolts
- 2 Lifting ropes

Figure 4-1

4.2 Installation into the system

	⚠ WARNING
	<p>Movable parts</p> <p>Human body parts may get jammed and severely injured.</p> <p>Do not connect or supply electrical power and compressed air before the product is completely mounted in the system.</p>

	NOTICE
	<p>Contamination</p> <p>Product may get contaminated.</p> <p>Always wear cleanroom gloves when handling the product.</p>

	NOTICE
	<p>Inappropriate tools</p> <p>Sealing surfaces may get damaged.</p> <p>Do not use sharp-edged tools.</p>

4.2.1 Admissible forces and bending moments

DN (nom. I.D.)		Axial tensile or compressive force «F _A »		Bending moment «M»			
mm	inch	N	lbf	Nm	lbf · ft		
200	8	500	112	64	47		
250	10	700	157	85	62		
320	12.5	1000	225	250	180		
400	16	2000	450	580	427		
500	20	2000	450	680	501		
630	25	2500	562	1050	774		
800	31.5	3000	674	1500	1106		
1000	40	3000	674	1800	1327		
<p>A combination of both forces «F_A» and «M» is prohibited. Please contact VAT for more information.</p>							

Table 4-1

4.3 Compressed air connection

	WARNING
	<p>Valve in open position Risk of injury when compressed air is connected to the valve. Connect compressed air only when:</p> <ul style="list-style-type: none"> – valve is installed in the vacuum system – moving parts cannot be touched

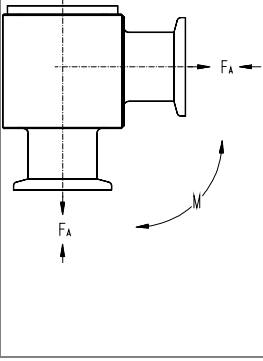

Use clean, dry or slightly oiled air only.



Admissible air pressure range, see product data sheet.

1. Connect compressed air according to the product data sheet and dimensional drawing.

4.4 Electrical connection

	DANGER
	<p>Electric shock Parts being under voltage will result in serious injury or death. Do not touch parts being under voltage.</p>

	NOTICE
	<p>Wrong voltage Electrical components may get damaged. Supply electrical components with the correct voltage.</p>

1. Connect solenoid valve according to the product data sheet and dimensional drawing.
2. Connect position indicator according to the product data sheet and dimensional drawing.

5 Operation

	⚠ WARNING
	<p>Unqualified personnel Inappropriate handling may cause serious injury or property damage. Only qualified personnel are allowed to carry out the described work.</p>

	⚠ WARNING
	<p>Movable parts Human body parts may get jammed and severely injured. Do not operate before product is installed completely into the vacuum system.</p>

5.1 Normal operation

Valve opens and closes pneumatically.

5.2 Operation under increased temperature

Maximum allowed temperature; see product data sheet.

5.3 Behavior in case of compressed air pressure drop

Depends on customer installation.

5.4 Behavior in case of power failure

Depends on customer installation.



5.5 Trouble shooting

Failure	Check	Action	See
Valve does not close / open	Air pressure	Connect compressed air	Product data sheet
	Voltage at solenoid valve	Connect correct voltage	Product data sheet and specification on solenoid valve

Table 5-1

If you need any further information, please contact one of our service centers. You will find the addresses on our website www.vatvalve.com.

6 Maintenance

	<p style="text-align: center;">⚠ WARNING</p> <p>Unqualified personnel Inappropriate handling may cause serious injury or property damage. Only qualified personnel are allowed to carry out the described work.</p>
	<p style="text-align: center;">⚠ WARNING</p> <p>Radioactive or toxic components Health hazard. Do not touch contaminated or toxic parts.</p>
	<p style="text-align: center;">⚠ WARNING</p> <p>Hazardous components Human body parts may get jammed and severely injured. Before starting maintenance:</p> <ul style="list-style-type: none"> – disconnect compressed air supply – disconnect electrical power supply
	<p style="text-align: center;">⚠ WARNING</p> <p>Heavy weight Physical overstraining. Use a crane to lift the product.</p>
	<p style="text-align: center;">NOTICE</p> <p>Contamination Product may get contaminated. Always wear cleanroom gloves when handling the product.</p>
	<p style="text-align: center;">NOTICE</p> <p>Inappropriate tools Sealing surfaces and valve plate may get damaged. Do not use sharp-edged tools.</p>

6.1 Maintenance intervals

Under clean operating conditions the valve does not require any maintenance during the specified cycles.

For more information or a general overhaul please contact one of our service centers. You will find the addresses on our website www.vatvalve.com.



Contamination from the process may require more frequent maintenance.

6.2 Required tools

- Allen wrench depending on valve size
- Torque wrench according «Table 6-1» on page 16
- Cleanroom wiper soaked with alcohol (2% methyl ethyl ketone)
- O-Ring removal tool; see «Table 11-1» on page 25

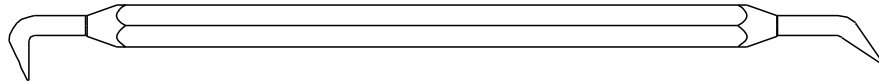

Figure 6-1

6.3 Replacement of vacuum seals

6.3.1 Dismount actuator / plate assembly

The follow item numbers in brackets refer to «Figure 6-2» on page 17.

1. Remove the screws (60) uniformly and crosswise.
2. Lift pneumatic actuator (26) carefully from body by using a crane; see chapter «4.1 Unpacking», «Figure 4-1».
3. Remove bonnet seal (62) from groove; use O-ring removal tool.

6.3.2 Replacement of plate seal

1. Dismount actuator / plate assembly; see chapter «6.3.1 Dismount actuator / plate assembly».
2. Remove the plate seal (61) with an O-ring removal tool.
3. Check sealing surface and clean it with alcohol (ethanol 2% methyl ethyl ketone).
4. Put new plate seal (61) on plate groove and press it crosswise into groove at 4 points.
5. Press plate seal uniformly into groove.
6. Mount actuator / plate assembly as follow chapter.

6.3.3 Mount actuator / plate assembly

1. Check and clean sealing surfaces of bonnet flange and valve seat.
2. Put bonnet seal (62) into groove.
3. Carefully insert actuator / plate assembly by using a crane.



Do not cant.

4. Fasten screws (60) uniformly and crosswise in 2 to 3 rounds with specified torques according table below.

DN200	DN250	DN320	DN400	DN500	DN630	DN800	DN1000
20 Nm	20 Nm	40 Nm	50 Nm	50 Nm	60 Nm	60 Nm	60 Nm

Table 6-1 Admissible torques

6.4 Replacement of shaft feedthrough seal and pneumatic seals

Please contact VAT. You will find the addresses on our website www.vatvalve.com.

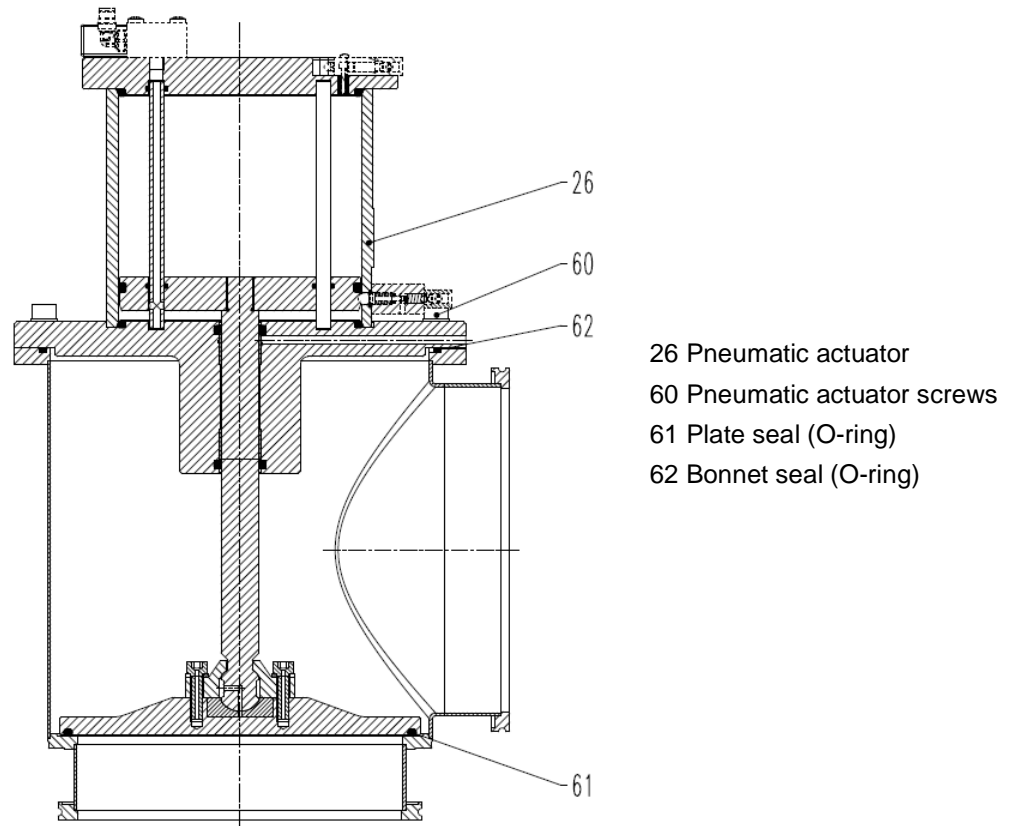







Figure 6-2

7 Repairs

Repairs may only be carried out by the VAT service staff. In exceptional cases, the customer is allowed to carry out the repairs, but only with the prior consent of VAT.

Please contact one of our service centers. You will find the addresses on our website www.vatvalve.com.

8 Dismounting and Storage

	<p style="text-align: center;">⚠ WARNING</p> <p>Unqualified personnel Inappropriate handling may cause serious injury or property damage. Only qualified personnel are allowed to carry out the described work.</p>
	<p style="text-align: center;">⚠ WARNING</p> <p>Radioactive or toxic components Health hazard. Do not touch contaminated or toxic parts.</p>
	<p style="text-align: center;">⚠ WARNING</p> <p>Heavy weight Physical overstraining. Use a crane to lift the product.</p>
	<p style="text-align: center;">⚠ WARNING</p> <p>Hazardous components Human body parts may get jammed and severely injured. Before dismounting the product:</p> <ul style="list-style-type: none"> – disconnect compressed air supply – disconnect electrical power supply
	<p style="text-align: center;">⚠ WARNING</p> <p>Movable parts Human body parts may get jammed and severely injured. Keep human body parts away from movable parts.</p>
	<p style="text-align: center;">NOTICE</p> <p>Contamination Product may get contaminated. Always wear cleanroom gloves when handling the product.</p>

8.1 Dismounting

NOTICE	
	<p>Valve in open position Valve body and plate may get damaged if valve is in open position. Close the valve before dismantling the valve from the system.</p>

1. Disconnect compressed air supply.
2. Disconnect electrical power supply.
3. Dismount valve from system.





8.2 Storage

NOTICE	
	<p>Wrong storage Inappropriate temperatures and humidity may cause damage to the product. Valve must be stored at: – relative humidity between 10% and 70% – temperature between +10 °C and +50 °C – non-condensing environment</p>

NOTICE	
	<p>Inappropriate packaging Product may get damaged if inappropriate packaging material is used. Always use the original packaging material and handle product with care.</p>

1. Clean / decontaminate valve.
2. Cover all valve openings with a protective foil.
3. Pack valve appropriately, by using the original packaging material.

9 Packaging and Transport

	<p style="text-align: center;">⚠ WARNING</p> <p>Unqualified personnel Inappropriate handling may cause serious injury or property damage. Only qualified personnel are allowed to carry out the described work.</p>
	<p style="text-align: center;">⚠ WARNING</p> <p>Harmful substances Risk of injury in case of contact with harmful substances. Remove harmful substances (e. g. toxic, caustic or microbiological ones) from valve before you return the valve to VAT.</p>
	<p style="text-align: center;">⚠ WARNING</p> <p>Heavy weight Physical overstraining. Use a crane to lift the product.</p>
	<p style="text-align: center;">NOTICE</p> <p>Inappropriate packaging Product may get damaged if inappropriate packaging material is used. Always use the original packaging material and handle product with care.</p>



- When returning products to VAT, please fill out the VAT form «Declaration of Chemical Contamination» and send it to VAT in advance. The form can be downloaded from our website www.vatvalve.com.
- If products are radioactively contaminated, the VAT form «Contamination and Radiation Report» must be filled out. Please contact VAT in advance.
- If products are sent to VAT in contaminated condition, VAT will carry out the decontamination procedure at the customer's expense.

9.1 Packaging

NOTICE	
	<p>Valve in open position Valve body and plate may get damaged if valve is in open position. Make sure that the valve is closed.</p>

1. Cover all valve openings with protective covers or foils.
2. Pack valve appropriately, by using the original packaging material.



VAT disclaims any liability for damages resulting from inappropriate packaging.



9.2 Transport

NOTICE	
	<p>Inappropriate packaging Product may get damaged if inappropriate packaging material is used. Always use the original packaging material and handle product with care.</p>



VAT disclaims any liability for damages resulting from inappropriate packaging.

10 Disposal

	 WARNING	
	Harmful substances Environmental pollution. Discard products and parts according to the local regulations.	

11 Spare parts



NOTICE

Non-original spare parts

Non-original spare parts may cause damage to the product.
Use original spare parts from VAT only.



- Please specify the fabrication number of the product when you place an order for spare parts; see chapter «1.1 Identification of product». This is to ensure that the appropriate spare parts are supplied.
- VAT makes a difference between spare parts that may be replaced by the customer and those that need to be replaced by the VAT service staff.
- «Figure 11-1» only contains spare parts that may be replaced by the customer. If you need any other spare parts, please contact one of our service centers. You will find the addresses on our website www.vatvalve.com.

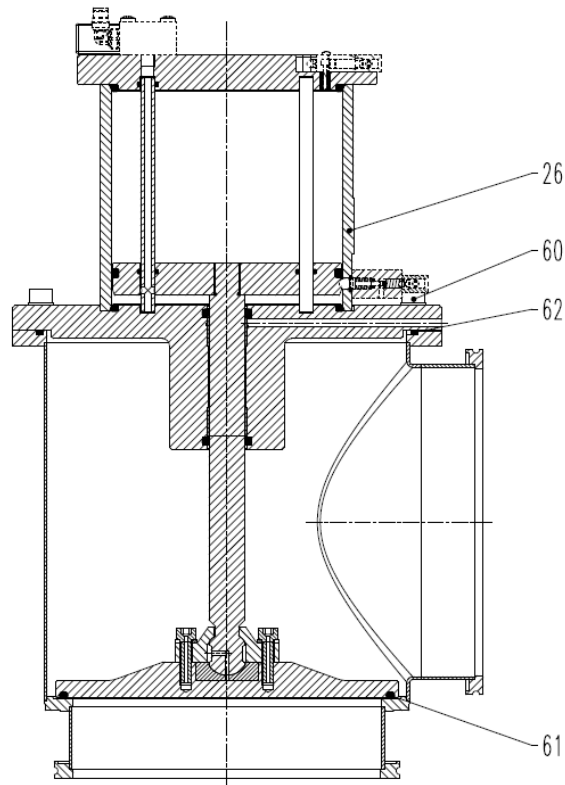

- 26 Pneumatic actuator
- 60 Pneumatic actuator screws
- 61 Plate seal (O-ring)
- 62 Bonnet seal (O-ring)

Figure 11-1

Item	Description	Part No.	Quantity per valve	Maintenance procedure see chapter
26	Pneumatic actuator	on request	1	«6.3 Replacement of vacuum seals»
60	Pneumatic actuator screws	on request	1	
61	Plate seal (O-ring)	on request	1	
62	Bonnet seal (O-ring)	on request	1	
–	O-ring removal tool	234859	1	

Table 11-1