

This drawing is the property of VAT.

Revision

Customer number

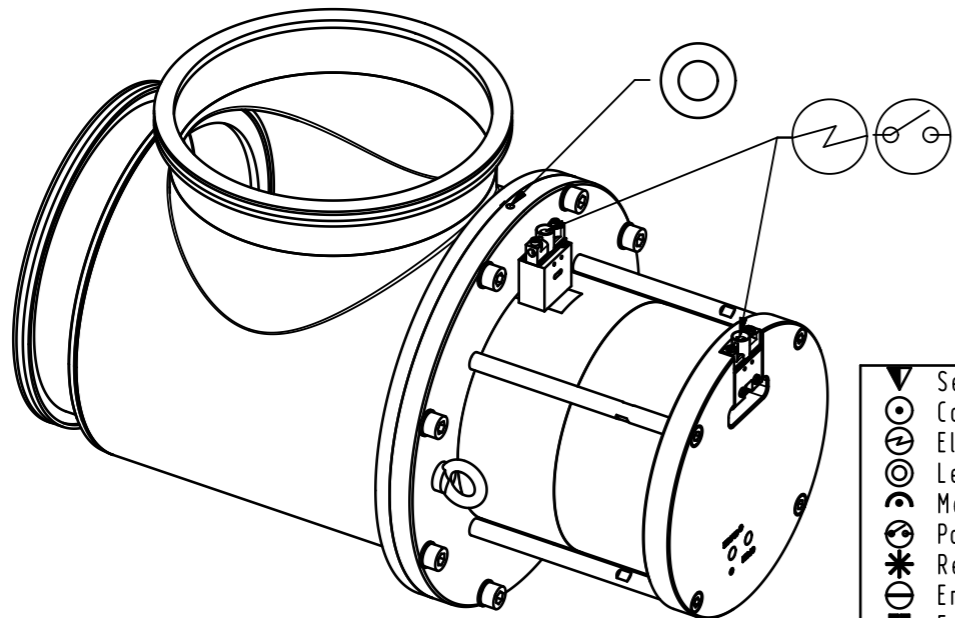
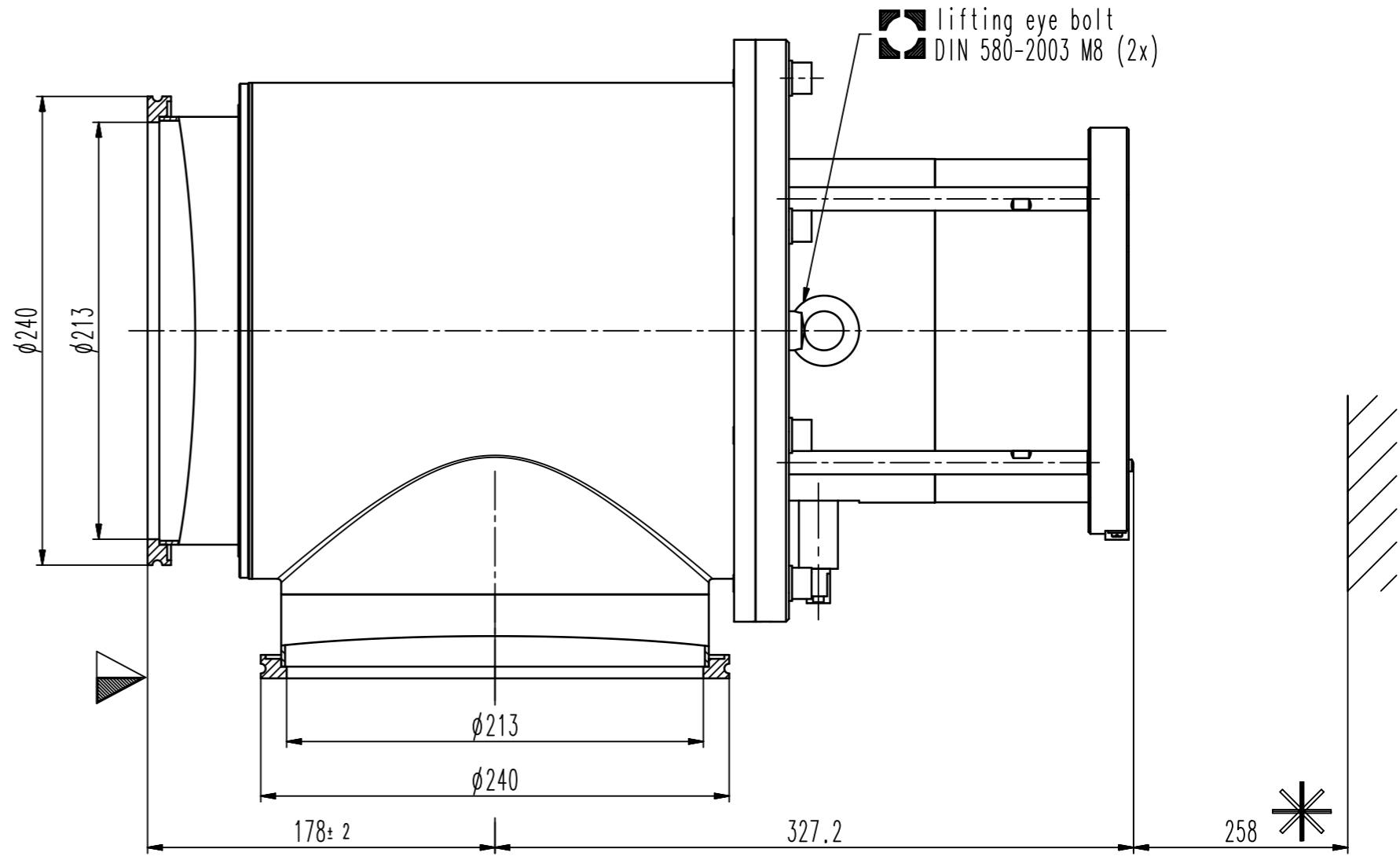
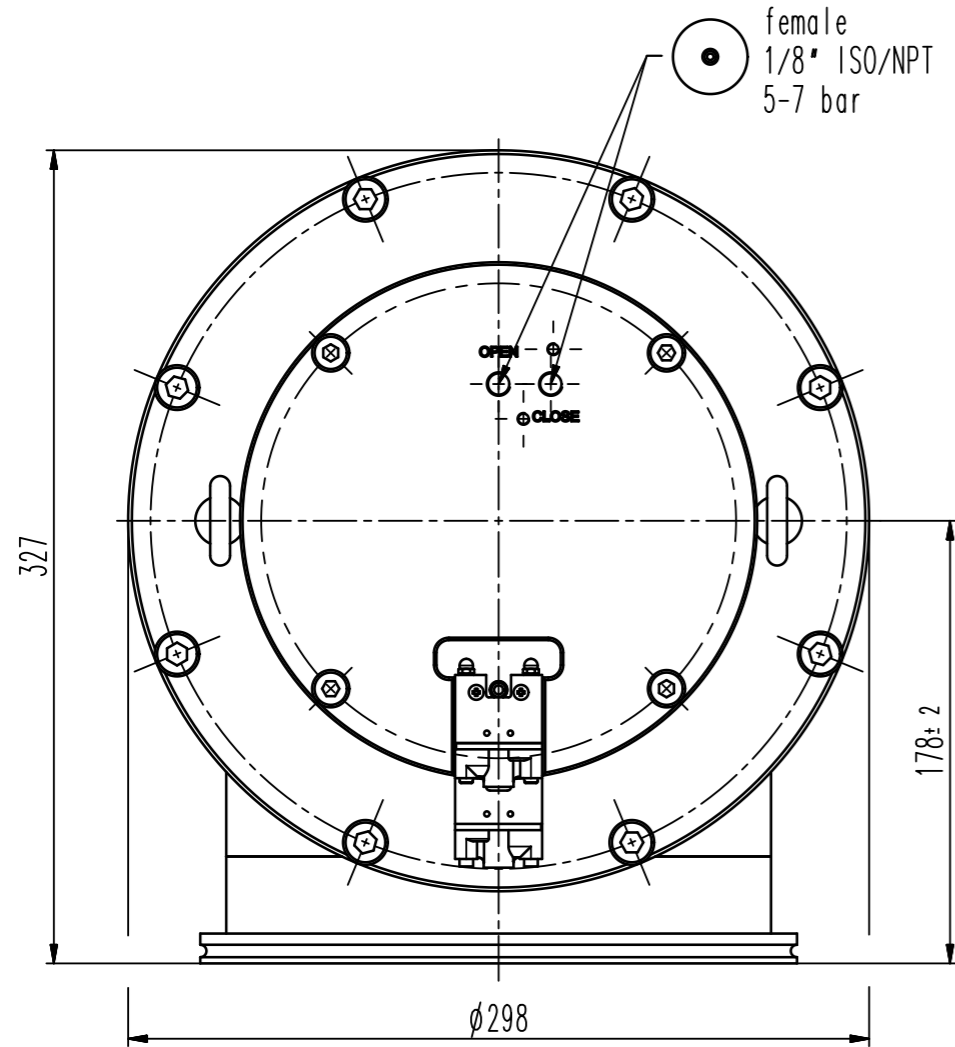

- ▼ Seat side
- ⊙ Comp. air connection
- ⊙ Electrical connection
- ⊙ Leak detection port
- ⊙ Mech. pos. indication
- ⊙ Position indicator
- ⊙ Required for dismantling
- ⊙ Emergency actuation
- ⊙ For attachment
- ⊙ Bake-out area
- ⊙ Differential pumping port

Vacuum angle valve



VAT Vakuumventile AG
CH-9469 Haag, Switzerland
Tel ++41 81 7716161 Fax ++41 81 7714830

Rev.-Date: 17.03.15
Visa: LIN

Series	244	Ordering No.	24446-QE24-0003
Projection E	DN	Flange	ISO-K
	200		
Dimensional Drawing		791324	Rev.