

This drawing is the property of VAT.

Revision

Customer number

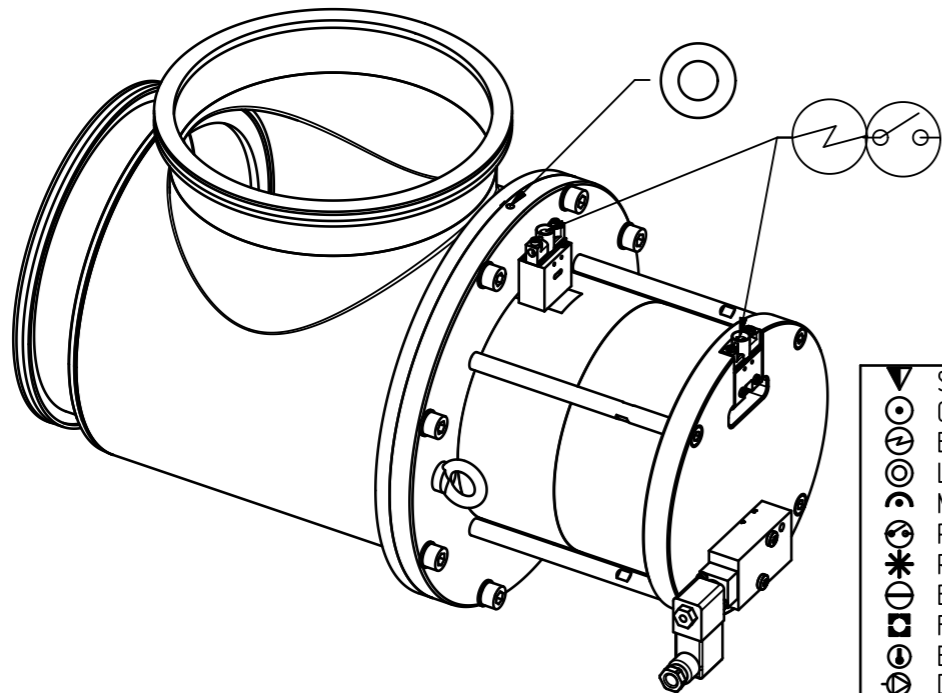
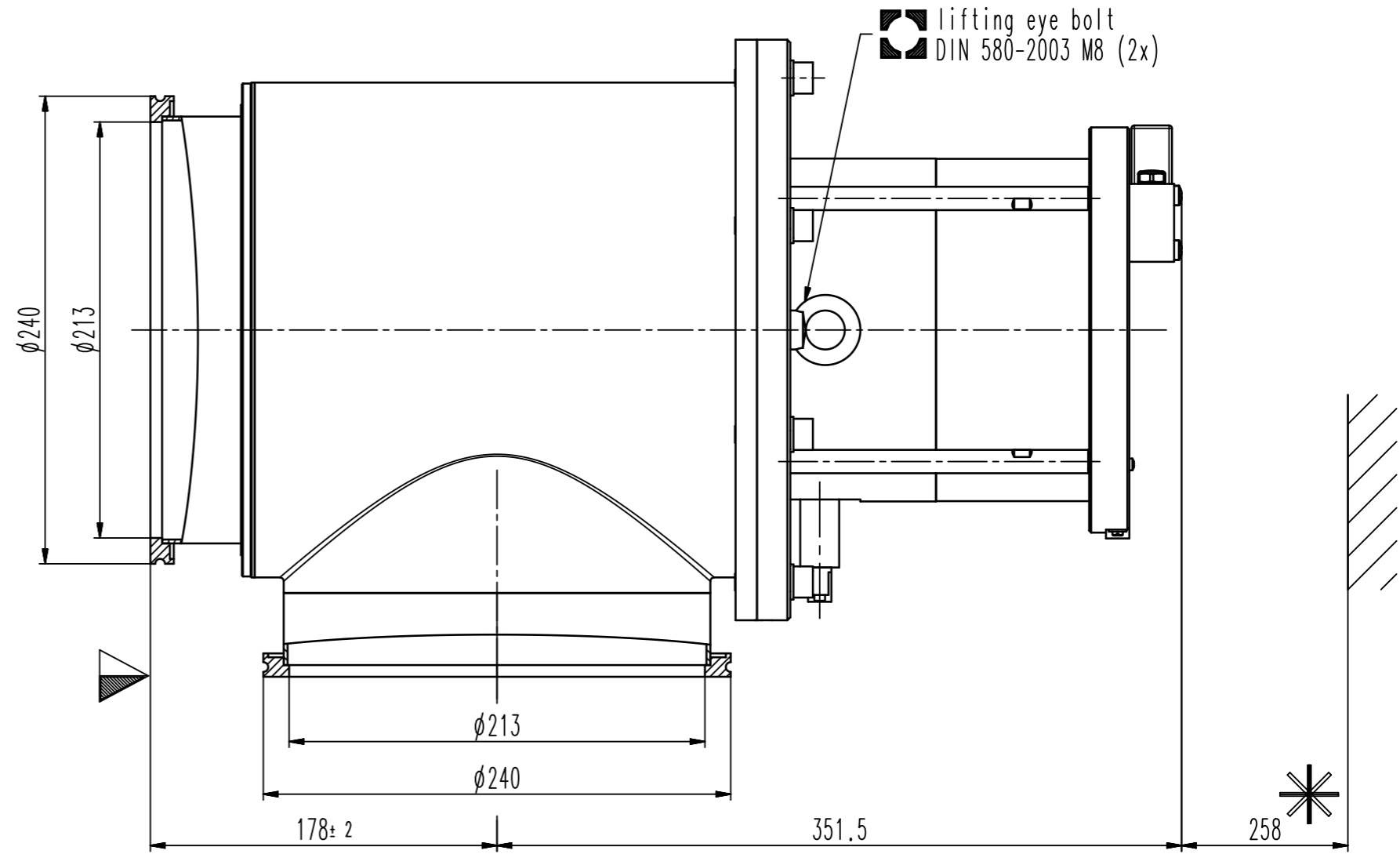
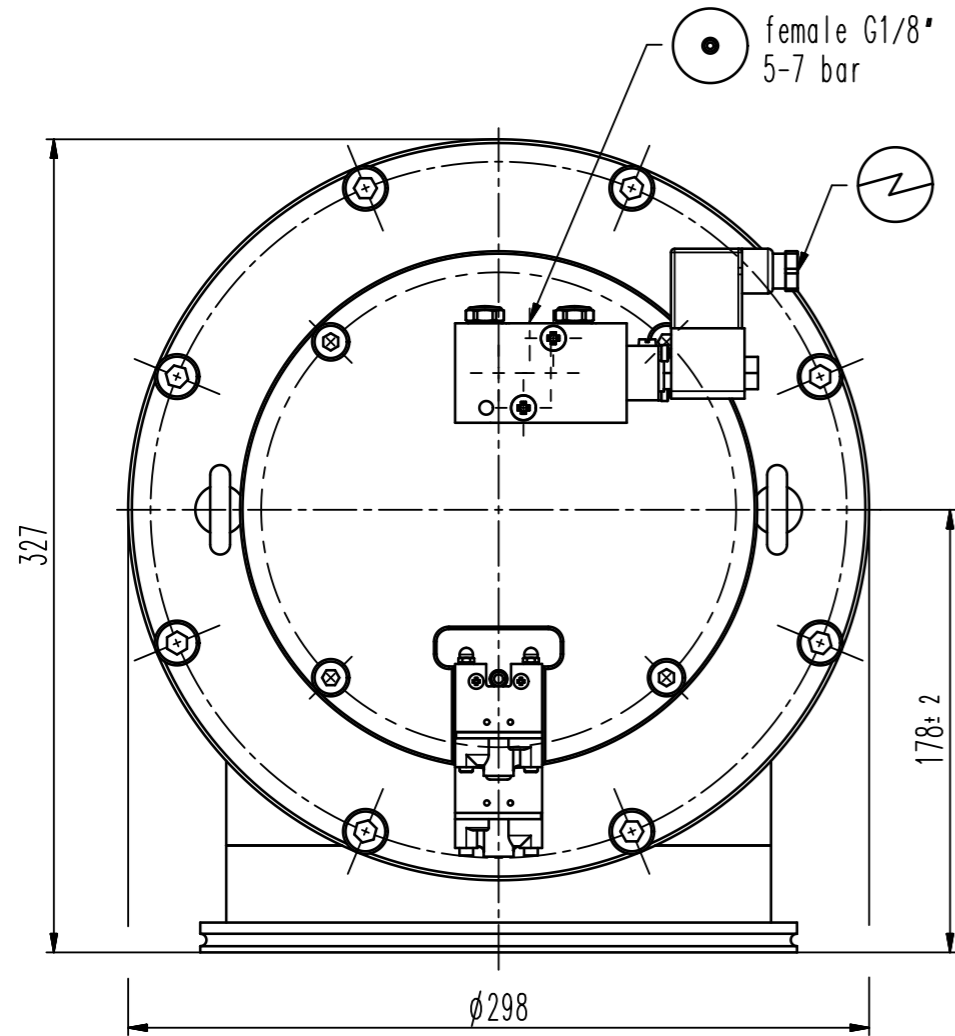

- ▼ Seat side
- ⊙ Comp. air connection
- ⊙ Electrical connection
- ⊙ Leak detection port
- ⊙ Mech. pos. indication
- ⊙ Position indicator
- ⊙ Required for dismantling
- ⊙ Emergency actuation
- ⊙ For attachment
- ⊙ Bake-out area
- ⊙ Differential pumping port

Vacuum angle valve



VAT Vakuumventile AG

CH-9469 Haag, Switzerland
Tel ++41 81 7716161 Fax ++41 81 7714830

Rev.-Date: 18.03.15

Visa: LIN

Series

244

Ordering No.

24446-QE44-0003

Projection E

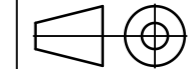

DN

200

Flange

ISO-K

Dimensional Drawing

791373

Rev.

VAT/DA