

This drawing is the property of VAT.

Revision

Customer number

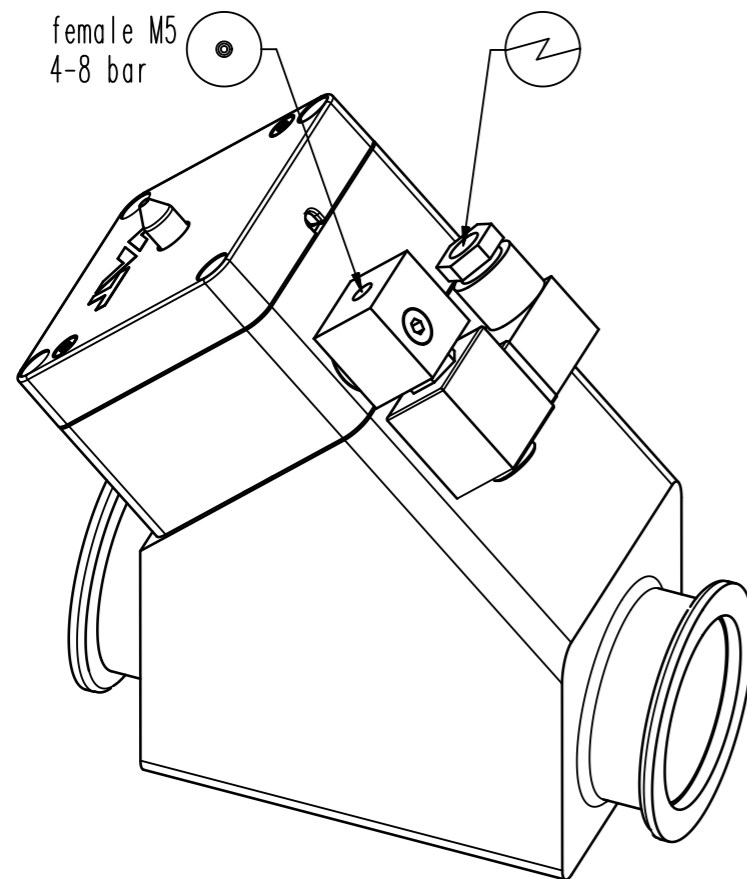
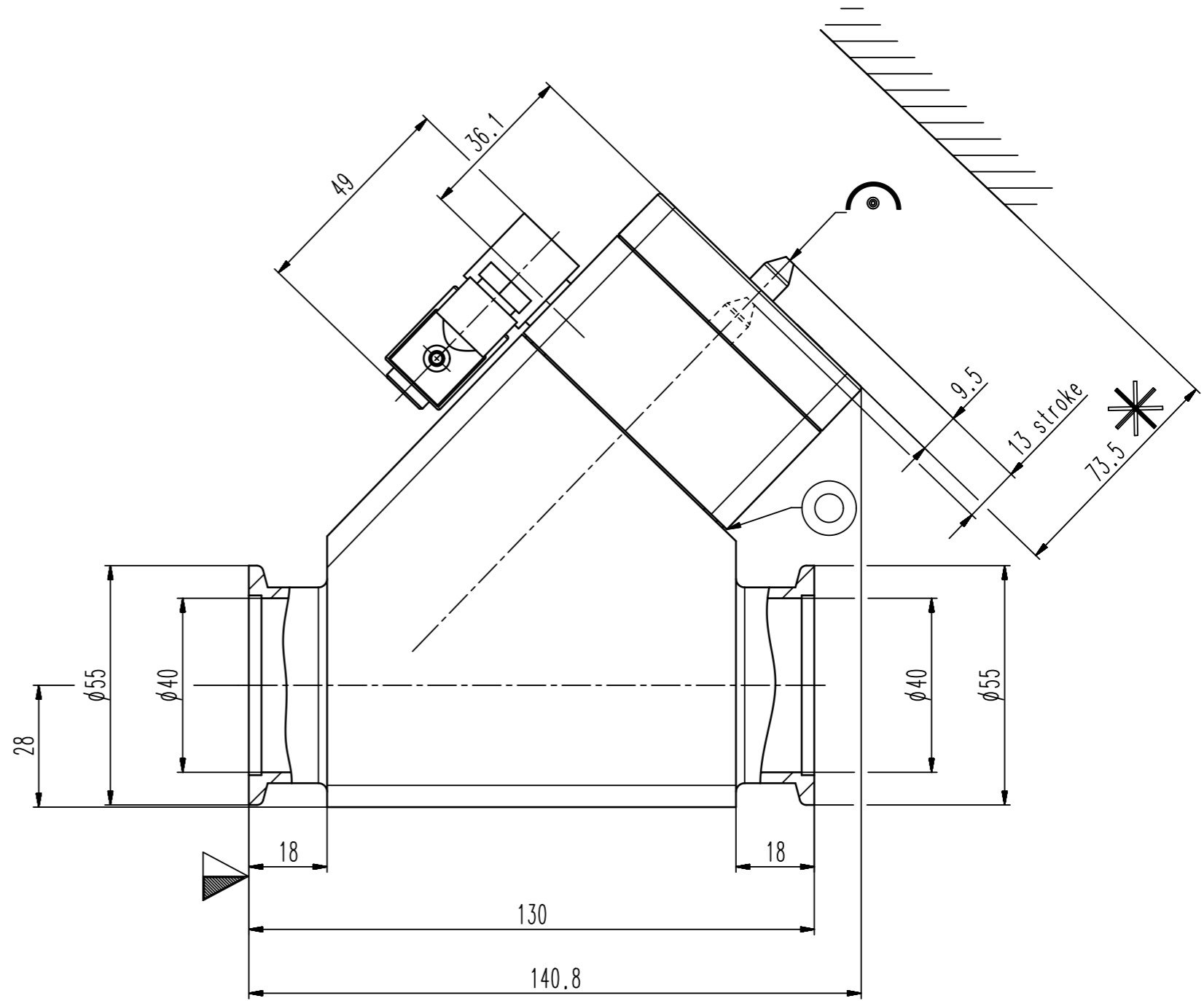
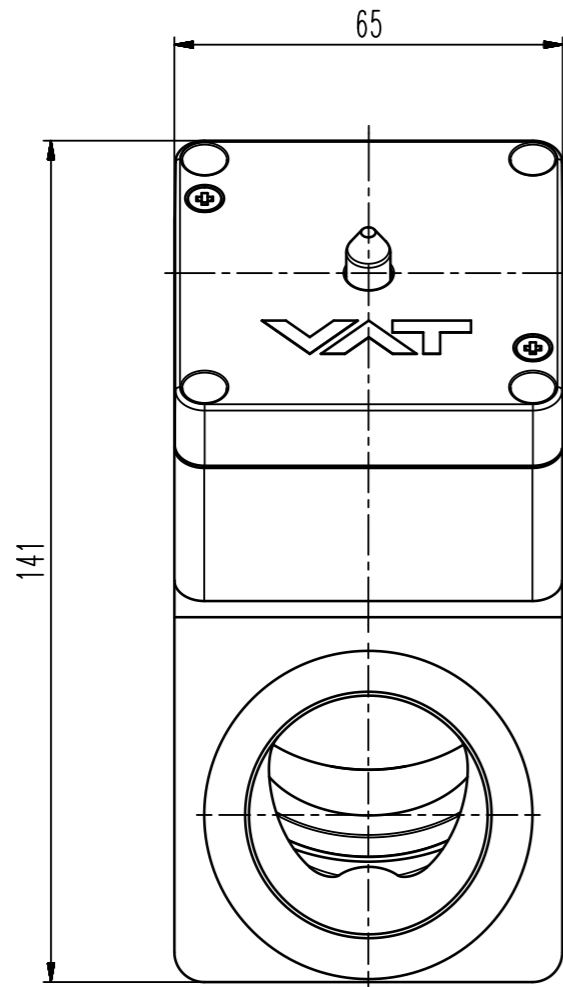

- ▼ Seat side
- ⊙ Comp. air connection
- ⊙ Electrical connection
- ⊙ Leak detection port
- ⊙ Mech. pos. indication
- ⊙ Position indicator
- ⊙ Required for dismantling
- ⊙ Emergency actuation
- ⊙ For attachment
- ⊙ Bake-out area
- ⊙ Differential pumping port

Vacuum inline valve



VAT Vakuumentile AG
 CH-9469 Haag, Switzerland
 Tel ++41 81 7716161 Fax ++41 81 7714830

Date: 18.11.04
 Name: VEA

Series	245	Ordering No.	24532-KA31-0001
Projection E	DN	Flange	
	40	ISO-KF	
Dimensional Drawing	256664	Rev.	D