

This drawing is the property of VAT.

Revision

Customer number

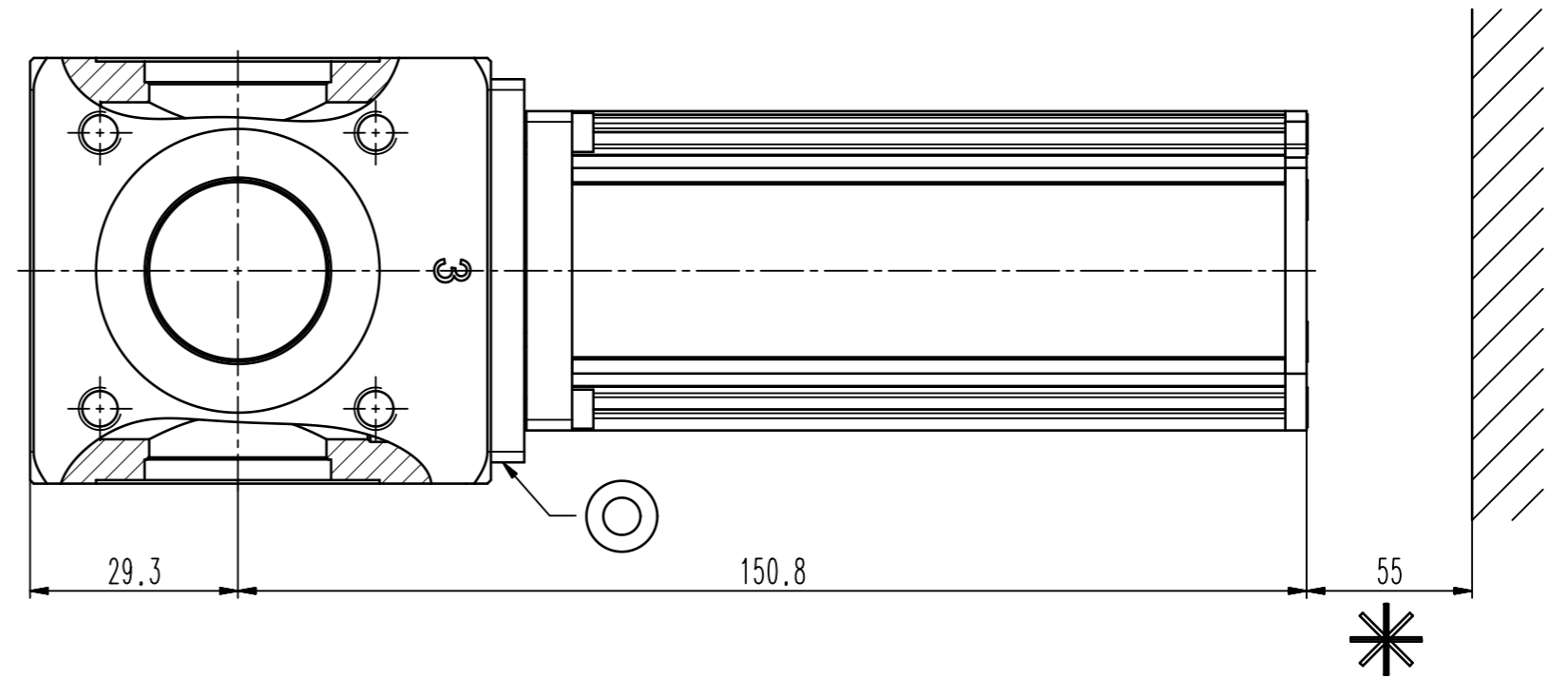
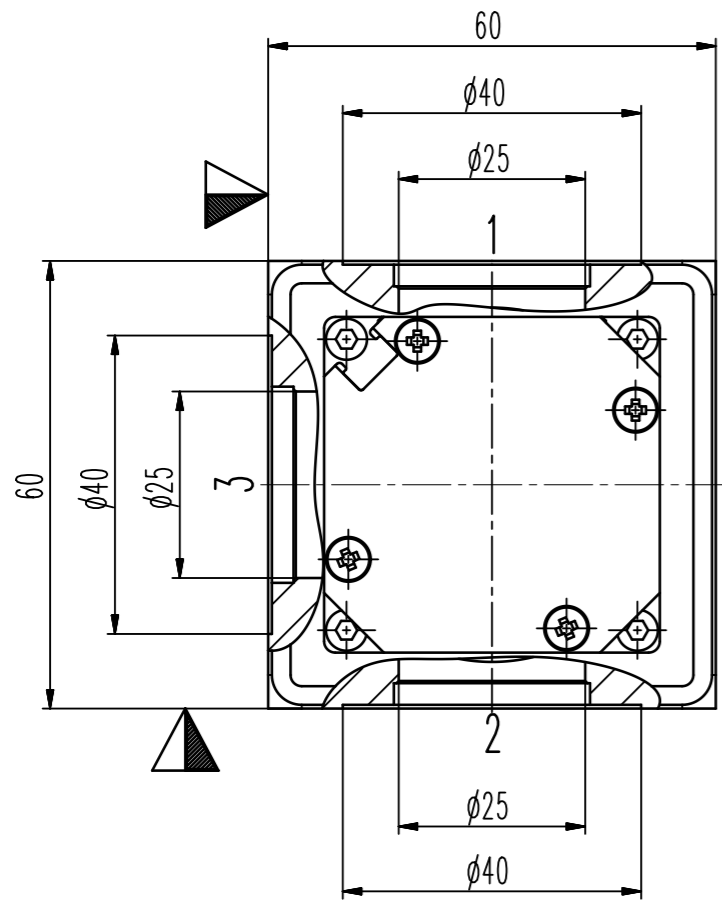

female M5
(10-32 UNF suitable)
4-8bar

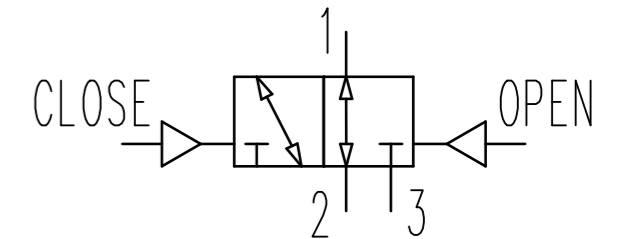
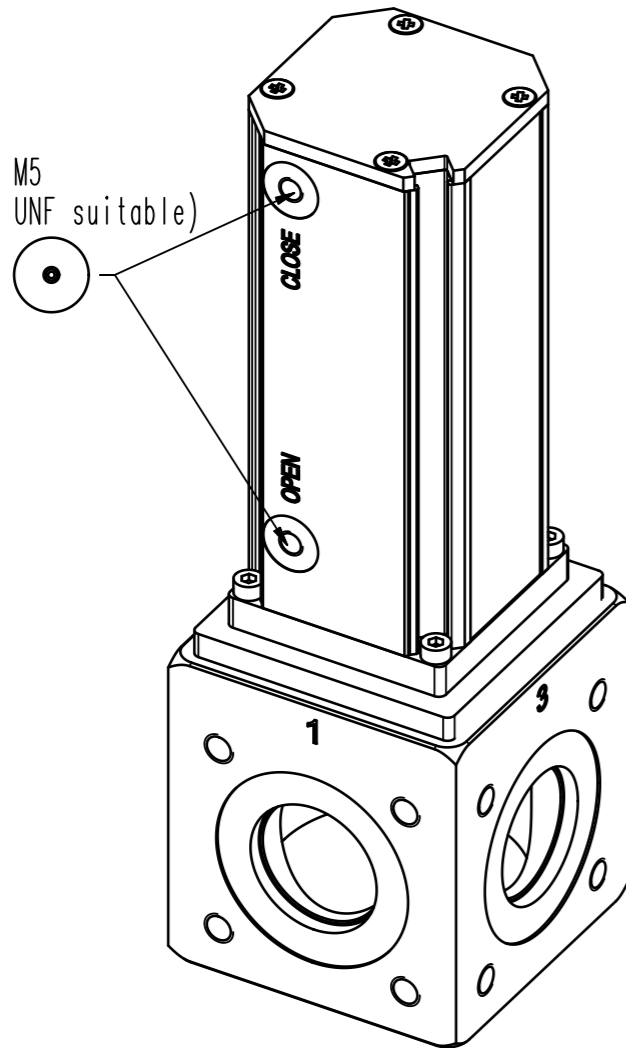

- ▼ Seat side
- ⊙ Comp. air connection
- ⊙ Electrical connection
- ⊙ Leak detection port
- ⊙ Mech. pos. indication
- ⊙ Position indicator
- ⊙ Required for dismantling
- ⊙ Emergency actuation
- ⊙ For attachment
- ⊙ Bake-out area
- ⊙ Differential pumping port

HV 3/2 way valve



VAT Vakuumventile AG

CH-9469 Haag, Switzerland
Tel ++41 81 7716161 Fax ++41 81 7714830

Rev.-Date: 13.10.11

Visa: EMI

Series

252

Ordering No.

25228-EA14-0001

Projection E

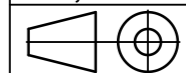

DN

25

Flange

ISO-KF c

Dimensional Drawing

511889

Rev.

VAT/DA