

This drawing is the property of VAT.

Revision

Customer number

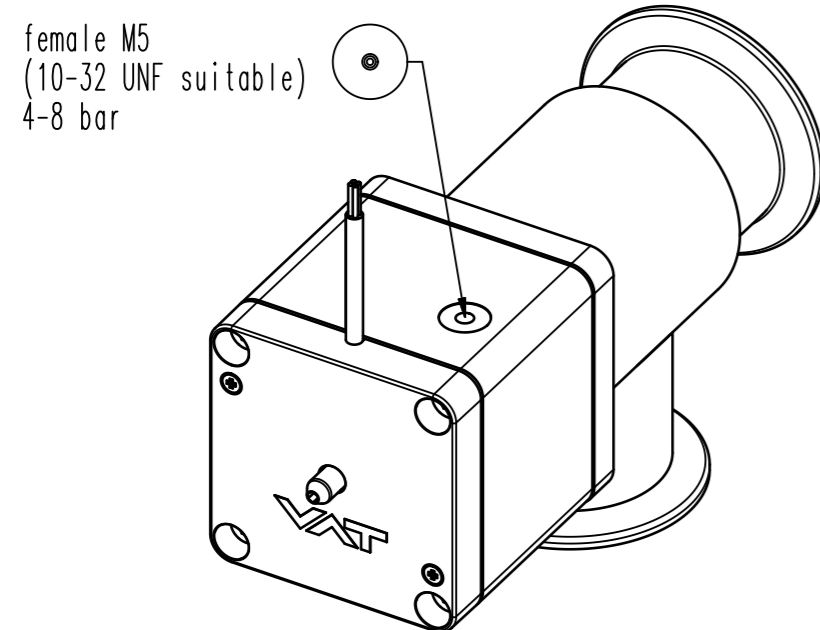
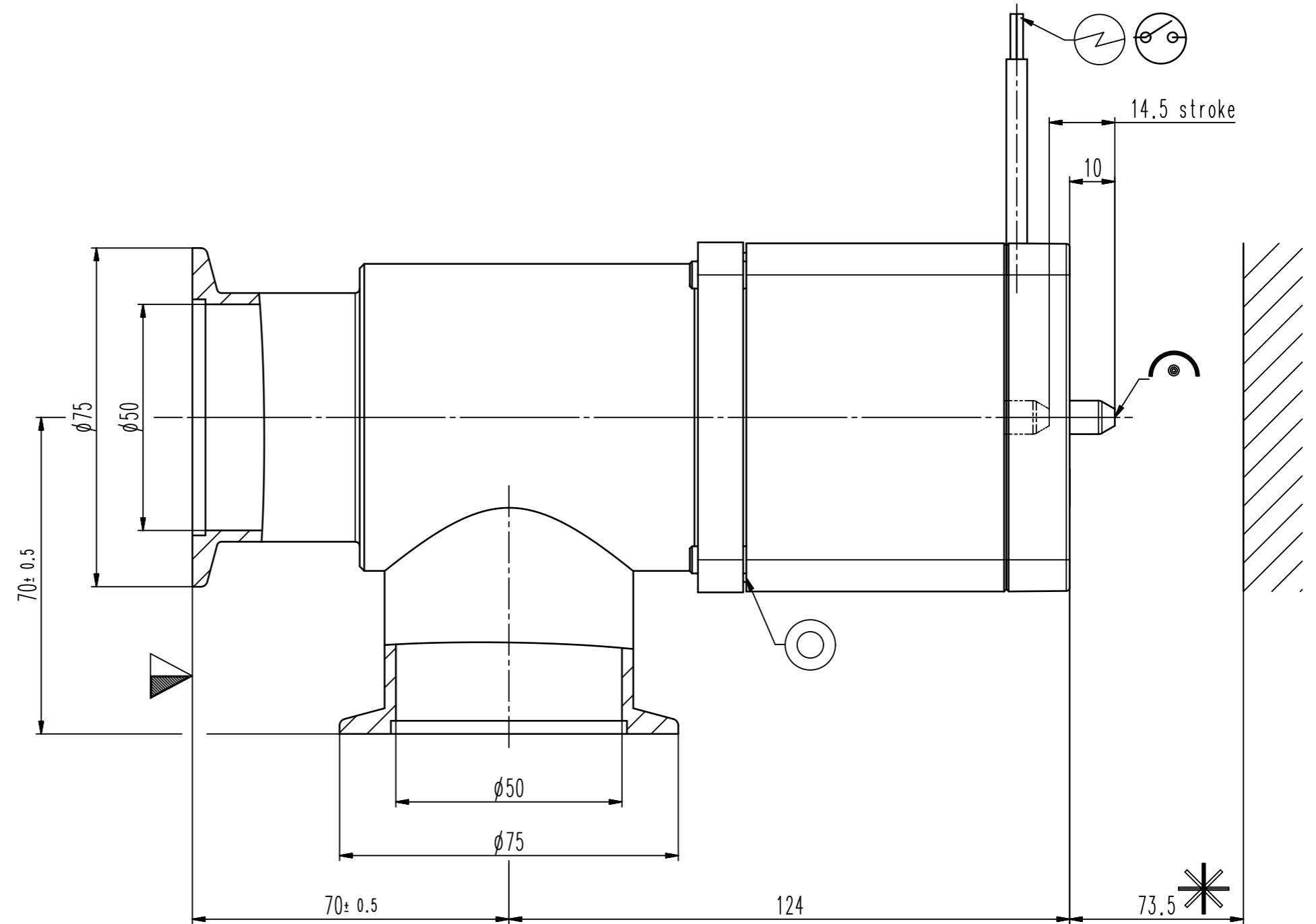
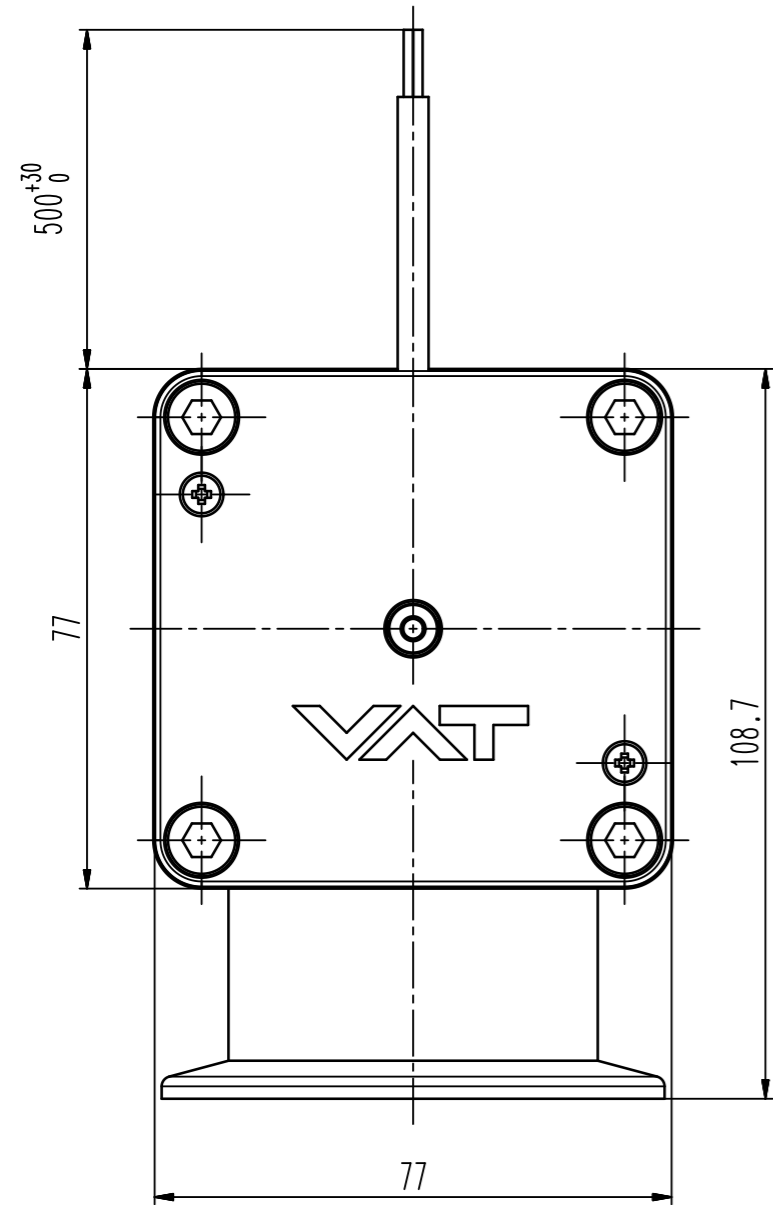

- ▼ Seat side
- ⊙ Comp. air connection
- ⊙ Electrical connection
- ⊙ Leak detection port
- ⊙ Mech. pos. indication
- ⊙ Position indicator
- ⊙ Required for dismantling
- ⊙ Emergency actuation
- ⊙ For attachment
- ⊙ Bake-out area
- ⊙ Differential pumping port

HV angle valve



VAT Vakuumventile AG
 CH-9469 Haag, Switzerland
 Tel ++41 81 7716161 Fax ++41 81 7714830

Rev.-Date: 21.06.13
 Visa: WARO

Series	264	Ordering No.	26434-KE22-0001
Projection E	DN	Flange	
	50	ISO-KF	
Dimensional Drawing	599304	Rev.	