



HV Angle valve (Series 264)

HV Inline valve (Series 265)

- with pneumatic actuator, single acting with closing spring (NC)

This manual is valid for the valve ordering number(s):

264...

265...

The fabrication number is indicated on each product as per the label below (or similar):

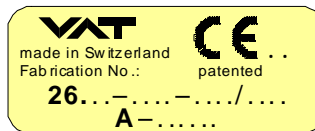

← Fabrication number



Explanation of symbols:



Read declaration carefully before you start any other action!



Keep body parts and objects away from the valve opening!



Attention!



Hot surfaces; do not touch!



Product is in conformity with EC guidelines, if applicable!



Loaded springs and/or air cushions are potential hazards!



Disconnect electrical power and compressed air lines. Do not touch parts under voltage!



Wear gloves!



Read these «**Installation, Operating & Maintenance Instructions**» and the enclosed «**General Safety Instructions**» carefully before you start any other action!



Installation, Operating & Maintenance Instructions

Series 264, DN 63 - 80 (I.D. 2¹/₂" - 3")

Series 265, DN 63 – 80 (I.D. 2¹/₂" - 3")

Imprint:

Manufacturer VAT Vakuumventile AG, CH-9469 Haag, Switzerland

Website	Phone	Fax	Email
www.vatvalve.com	+41 81 771 61 61	+41 81 771 48 30	CH@vatvalve.com

Publisher VAT Vakuumventile AG, CH-9469 Haag, Switzerland

Editor VAT Vakuumventile AG, CH-9469 Haag, Switzerland

Print VAT Vakuumventile AG, CH-9469 Haag, Switzerland

Copyright © VAT Vakuumventile AG 2008

No part of these Instructions may be reproduced in any way (photocopies, microfilms or any other reproduction processes) nor may it be manipulated with electronic systems, duplicated or distributed without written permission from VAT. Offenders are liable to pay damages.

The original VAT firmware and updated state of the art versions of the VAT firmware are intended for use with VAT products. The VAT firmware contains a limited, time unlimited user license. The VAT firmware may not be used for purposes other than those intended nor is it permitted to make copies of the VAT firmware. In particular, it is strictly forbidden to give copies of the VAT firmware to other people.

The use of trade names, brand names, trademarks, etc. in these Instructions does not entitle third parties to consider these names to be unprotected and to use them freely. This is in accordance with the meaning of the laws and acts covering brand names and trademarks.



Contents:

1	Use of product	4
1.1	Technical data for standard valve	4
2	Installation.....	5
2.1	Unpacking.....	5
2.2	Installation into the system.....	5
2.3	Connections	5
2.3.1	Compressed air connection	5
2.3.2	Electrical connection	6
3	Operation	8
3.1	Normal operation.....	8
3.2	Operation under increased temperature	8
3.3	Behavior in case of compressed air pressure failure	8
3.4	Behavior in case of power failure	8
4	Trouble shooting.....	8
5	Maintenance & repairs.....	9
5.1	Replacement of vacuum seals.....	9
5.1.1	Dismount "actuator/gate assembly"	9
5.1.2	Replacement of plate seal	9
5.1.3	Mount "actuator/plate assembly"	10
6	Drawing.....	10
7	Spare parts	11
8	Warranty.....	12



1 Use of product

Use product for clean and dry indoor vacuum applications under the conditions indicated in chapter «Technical data» only!
Other applications are only allowed with the written permission of VAT.

1.1 Technical data for standard valve

Leak rate	1 x 10 ⁻⁹ mbar l / s	
Pressure range when valve is open	1 x 10 ⁻⁸ mbar to 4 bar (abs)	
Conductance in high vacuum	DN 63: 160 l s ⁻¹ DN 80: 200 l s ⁻¹	
Differential pressure on the plate		
in opening direction	DN 63: ≤ 2 bar DN 80: ≤ 1,2 bar	
in closing direction	DN 63: ≤ 5 bar DN 80: ≤ 4 bar	
Differential pressure at opening	≤ 1 bar in either direction	
Admissible temperature	valve body	0°C to 150°C
	actuator	0°C to 120°C
	position indicator	0°C to 80°C
	solenoid	0°C to 80°C
Cycles until first service	3 million at T _{max} 80°C	
Position indicator contact rating	voltage	50 V AC / DC
	current	0,1 A
	power	1,0 W
Position indicator cable	standard 500 mm, no plug	
Solenoid	voltage	see label on solenoid

Technical data for valve with specific options according to «product data sheet».

Product data sheet on request.



2 Installation

2.1 Unpacking

Before unpacking the valve, make sure that the packaging is in impeccable condition and the valve has not suffered damage.

Note! The plastic packing material and/or protective covers may only be removed immediately before the valve is mounted into the system. Unprotected sealing surfaces must be treated with care and kept clean.

2.2 Installation into the system

DN (nom. I.D.)		Axial tensile or compressive force «F _A »		Bending moment «M»	
mm	inch	N	lbf	Nm	lbf · ft
63	2 1/2	200	45	18	13
80	3	225	50	22	16

A combination of both forces «F_A» and «M» is prohibited. Please contact VAT.

2.3 Connections

2.3.1 Compressed air connection



- Connect compressed air only when
- valve is installed into the system
 - moving parts cannot be touched

The valve is closed by a spring at compressed air failure.

Connection: Internal thread 1/8" ISO/NPT (adapter as option)

Compressed air pressure (min. - max. overpressure): 4 - 8 bar / 60 - 115 psi

Use clean, dry or slightly oiled air only!



2.3.2 Electrical connection



Do not touch parts under voltage!



Hot surfaces; do not touch!



Connect electrical power only when
- valve is installed into the system
- moving parts cannot be touched

Make sure that the control voltage is in accordance with the voltage stated on the solenoid!

Plug for the solenoid is supplied with the valve.

Connections:

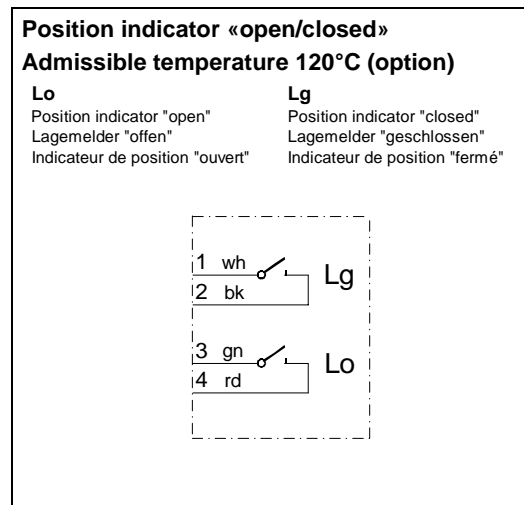
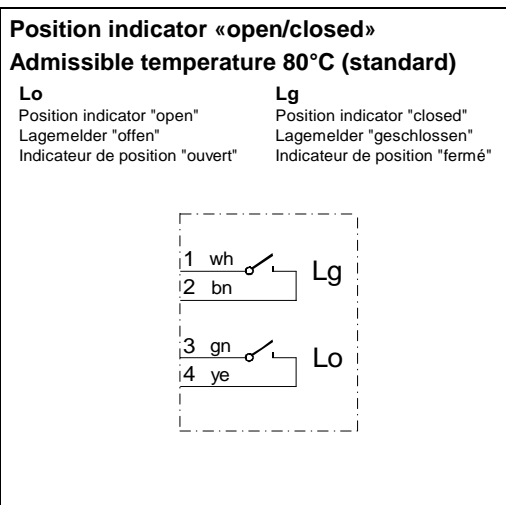
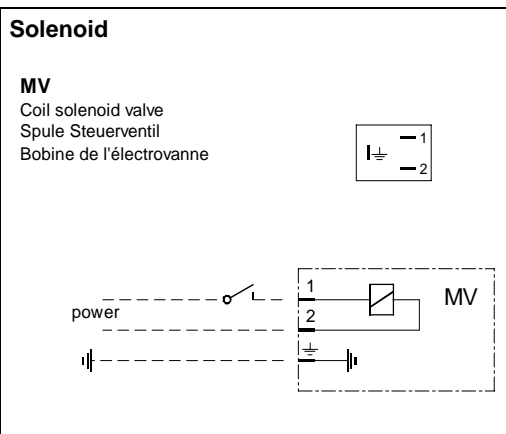



Installation, Operating & Maintenance Instructions

Series 264, DN 63 - 80 (I.D. 2 1/2" - 3")

Series 265, DN 63 - 80 (I.D. 2 1/2" - 3")

Position indicator with plug (option)

Plug 7 pin (standard wiring)

Lo Position indicator "open" Lagemelder "offen" Indicateur de position "ouvert"	Lg Position indicator "closed" Lagemelder "geschlossen" Indicateur de position "fermé"
---	--

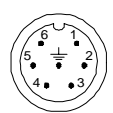
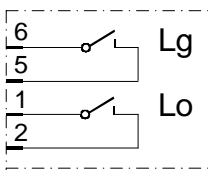
D-sub plug 9 pin

Lo Position indicator "open" Lagemelder "offen" Indicateur de position "ouvert"	Lg Position indicator "closed" Lagemelder "geschlossen" Indicateur de position "fermé"
---	--

Betriebsspannung
max. 50 V DC



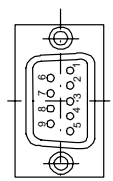
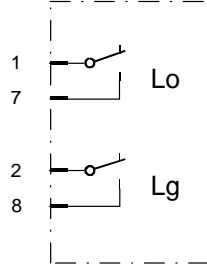

M8 plug 4 pin

Lo Position indicator "open" Lagemelder "offen" Indicateur de position "ouvert"	Lg Position indicator "closed" Lagemelder "geschlossen" Indicateur de position "fermé"
---	--

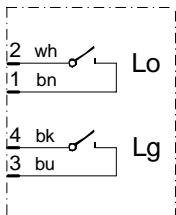

male-view on pins



Common connector for solenoid and position indicator (option)

Plug 7 pin (standard wiring)

Lo Position indicator "open" Lagemelder "offen" Indicateur de position "ouvert"	Lg Position indicator "closed" Lagemelder "geschlossen" Indicateur de position "fermé"
---	--

MV
Coil solenoid valve
Spule Steuerventil
Bobine de l'électrovanne

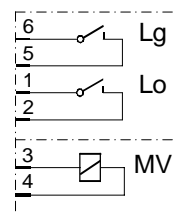

3 Operation

3.1 Normal operation

Valve with pneumatic actuator: - valve is closed by a spring (NC)
- valve is opened pneumatically

3.2 Operation under increased temperature

See «1.1 Technical data»

3.3 Behavior in case of compressed air pressure failure

Valve closed: valve remains closed and leaktight
Valve open: valve closes leaktight

3.4 Behavior in case of power failure

Valve with solenoid valve:
Valve is closed leak tight by a spring

Valve without solenoid valve:
Depending on the installation of the customer

4 Trouble shooting

Failure	Check	Action
Valve does not open	Power available?	Connect correct voltage
	Compressed air available?	Connect correct air pressure

If you need any further information, please contact one of our service centers. You can find the addresses on our website:
<http://www.vat.ch>



5 Maintenance & repairs

Under clean operating conditions, the valve does not require any maintenance during the specified cycle life. Contamination from the process may influence the function and requires more frequent maintenance.

Before carrying out any maintenance or repairs, please contact VAT. It has to be individually decided whether the maintenance/repair can be performed by the customer or has to be carried out by VAT. The fabrication number on the valve

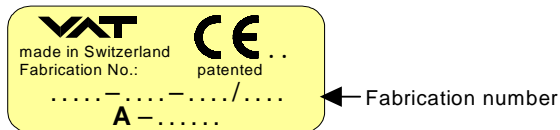

has always to be specified.

All supplies (e. g. compressed air, electrical power) must be disconnected for removal/installation of the valve from/into the system and for maintenance work.



Even with disconnected supply, loaded springs and/or air cushions in cylinders can be potential hazards.



Keep fingers and objects away from the valve opening!

Products returned to VAT must be free of harmful substances such as e.g. toxic, caustic or microbiological ones. If products are radioactively contaminated, fill in the VAT form «Contamination and Radiation Report» and send it with the product. The form is available at VAT. The maximum values indicated in the form must not be exceeded.

5.1 Replacement of vacuum seals

The item numbers in brackets refer to the drawing on page 10

5.1.1 Dismount "actuator/gate assembly"



- Remove 4 screws (60) uniformly and crosswise
Attention: Loaded spring!
- Withdraw "actuator/gate assembly" carefully from body (pneumatic actuator)
- Remove bonnet seal (O-ring, 62) from groove

5.1.2 Replacement of plate seal



- Stick a needle into the O-ring (61) and pull it out of groove
Attention: Do not damage the sealing surface!
- Check sealing surface and clean it with alcohol
- Put new O-ring (61) on plate groove and press it crosswise into groove at 4 points
- Press O-ring uniformly into groove

5.1.3 Mount "actuator/plate assembly"

- Check and clean sealing surfaces of bonnet flange and valve seat
- Put bonnet seal (O-ring, 62) into body
- Insert "actuator/plate assembly" carefully. Do not cant!
- Fasten 4 screws (60) uniformly and crosswise in 2 to 3 steps
- Perform function and leak test

6 Drawing

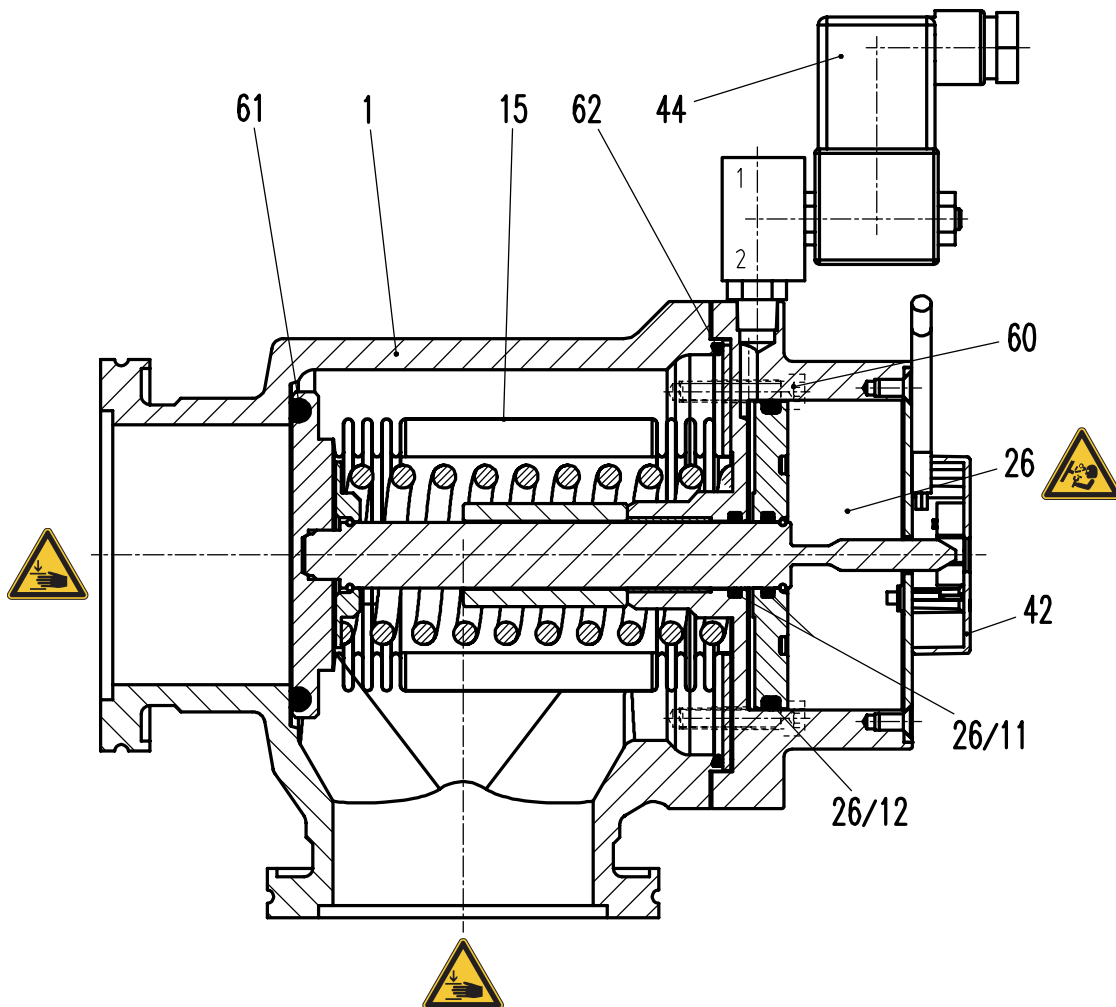



7 Spare parts



Please specify the **fabrication number of the valve** (see yellow label on valve) when ordering spare parts. This is to ensure that the appropriate spare parts are supplied.

Item	Description	Extras
1	Body	
15	Bellows feedthrough complete	
26	Actuator complete	
26/11	O-rings for pneumatic actuator	
26/12	O-ring for pneumatic actuator	
42	Position indicator complete	
44	Solenoid valve	
61	Plate seal (O-ring)	
62	Bonnet seal (O-ring)	
61/62	Sealing kit vacuum	
	VAT high temperature pneumatic grease	12 g

Solenoid	Item	Description	Voltage (±10 %)
	44	solenoid	12 VDC
			24 VDC
			48 VDC
			110 VDC
			24 VAC / 50 Hz
			24 VAC / 60 Hz
			48 VAC / 50 Hz
			100 VAC / 50-60 Hz
			110-115 VAC / 50 Hz
			110-115 VAC / 60 Hz
			200 VAC / 50-60 Hz
			220-230 VAC / 50 Hz
			220-230 VAC / 60 Hz



8 Warranty

Each product sold by VAT Vakuumventile AG (VAT) is warranted to be free from the manufacturing defects that adversely affect the normal functioning thereof during the warranty period stated in VAT's «Terms of Sale» immediately following delivery thereof by VAT, provided that the same is properly operated under conditions of normal use and that regular, periodic maintenance and service is performed or replacements made, in accordance with the instructions provided by VAT. The foregoing warranty shall not apply to any product or component that has been repaired or altered by anyone other than an authorized VAT representative or that has been subject to improper installation or abuse, misuse, negligence or accident. VAT shall not be liable for any damage, loss, or expense, whether consequential, special, incidental, direct or otherwise, caused by, arising out of or connected with the manufacture, delivery (including any delay in or failure to deliver), packaging, storage or use of any product sold or delivered by VAT shall fail to conform to the foregoing warranty or to the description thereof contained herein, the purchaser thereof, as its exclusive remedy, shall upon prompt notice to VAT of any such defect or failure and upon the return of the product, part or component in question to VAT at its factory, with transportation charges prepaid, and upon VAT's inspection confirming the existence of any defect inconsistent with said warranty or any such failure, be entitled to have such defect or failure cured at VAT's factory and at no charge therefor, by replacement or repair of said product, as VAT may elect. VAT MAKES NO WARRANTY OR REPRESENTATION OF ANY KIND, EXPRESS OR IMPLIED, (INCLUDING NO WARRANTY OR MERCHANTABILITY), EXCEPT FOR THE FOREGOING WARRANTY AND THE WARRANTY THAT EACH PRODUCT SHALL CONFORM TO THE DESCRIPTION THEREOF CONTAINED HEREIN, and no warranty shall be implied by law.

Furthermore, the «Terms of sale» at the back of the price list are applicable.