

This drawing is the property of VAT.

Revision

Customer number

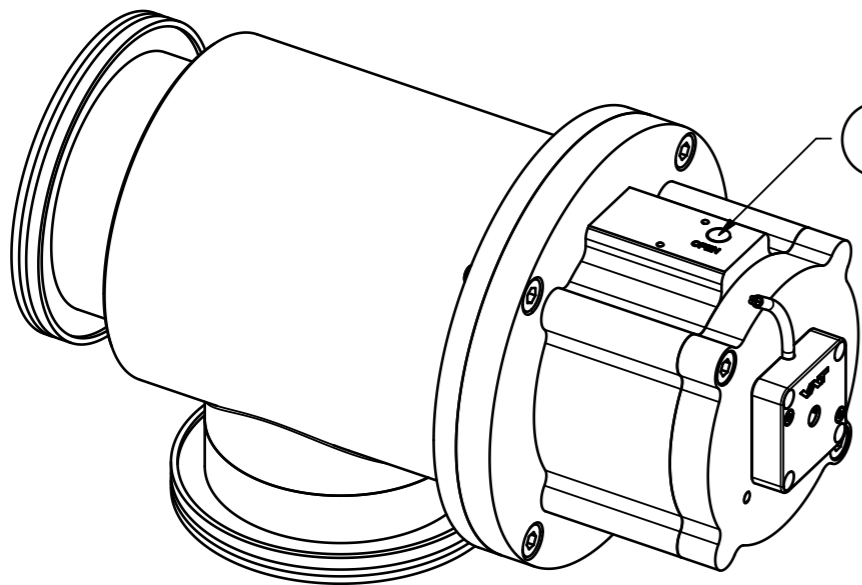
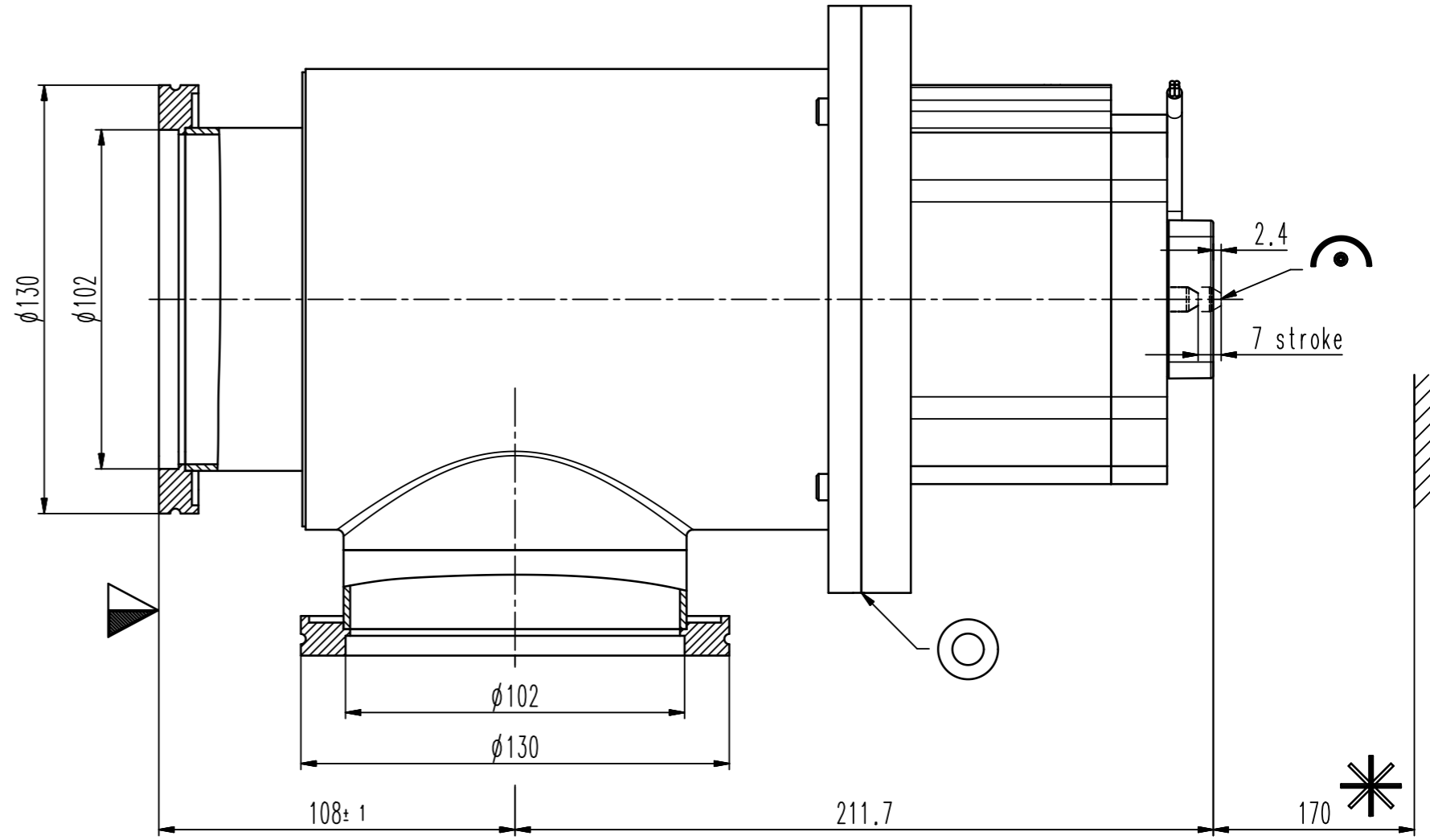
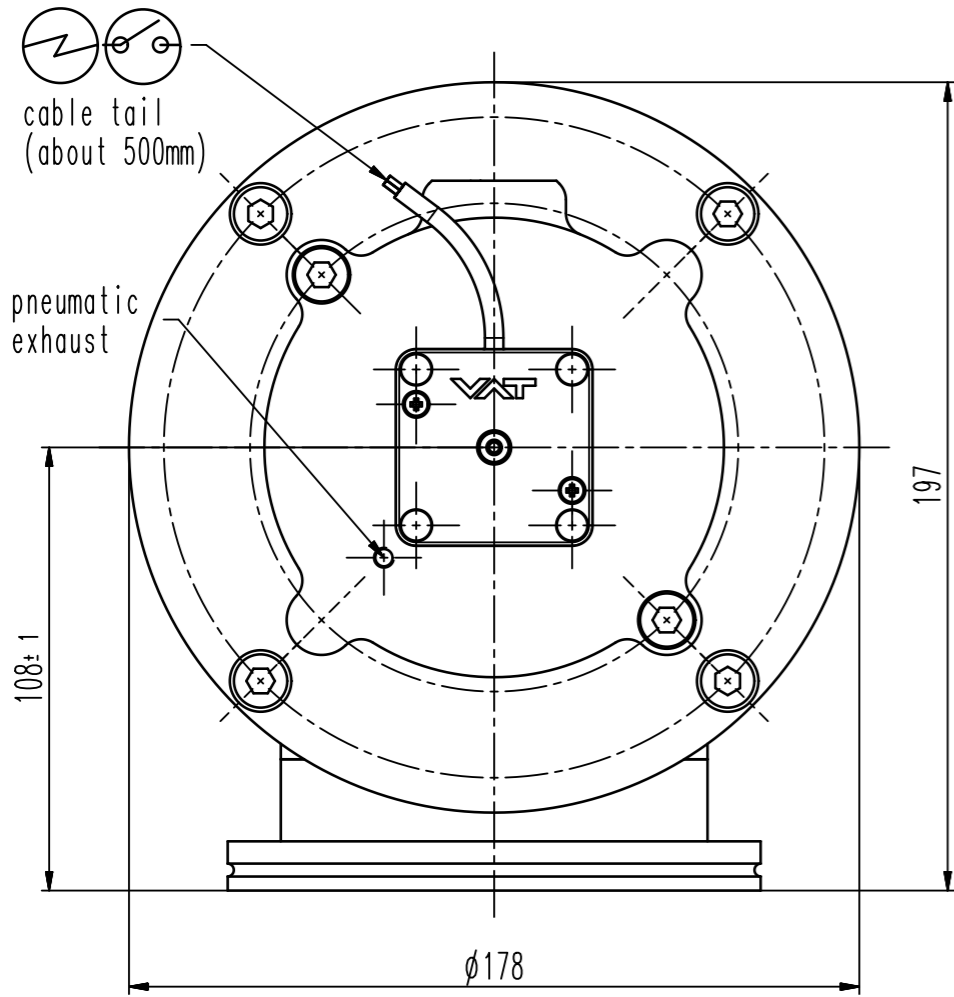

female
1/8" ISO/NPT
4.5-7 bar

- ▼ Seat side
- ⊙ Comp. air connection
- ⊙ Electrical connection
- ⊙ Leak detection port
- ⊙ Mech. pos. indication
- ⊙ Position indicator
- ⊙ Required for dismantling
- ⊙ Emergency actuation
- ⊙ For attachment
- ⊙ Bake-out area
- ⊙ Differential pumping port

HV angle valve



VAT Vakuumventile AG
CH-9469 Haag, Switzerland
Tel ++41 81 7716161 Fax ++41 81 7714830

Rev.-Date: 02.02.15
Visa: SLU

Series	264	Ordering No.	26440-QE21-0001
Projection E	DN	Flange	ISO-K
	100		
Dimensional Drawing	563621	Rev.	A