

HV angle valve with pneumatic actuator single acting with closing spring (NC)

Series 264
DN 10 – 50 mm (I. D. $\frac{3}{8}$ " – 2")

HV inline valve with pneumatic actuator single acting with closing spring (NC)

Series 265
DN 10 – 50 mm (I. D. $\frac{3}{8}$ " – 2")

This manual is valid for the following product ordering numbers:

264 .. - -

265 .. - -



Sample picture



Imprint

Manufacturer VAT Vakuumentile AG, CH-9469 Haag, Switzerland

Website: www.vatvalve.com
Phone: +41 81 771 61 61
Fax: +41 81 771 48 30
Email: CH@vatvalve.com

Publisher VAT Vakuumentile AG, CH-9469 Haag, Switzerland

Editor VAT Vakuumentile AG, CH-9469 Haag, Switzerland

Print VAT Vakuumentile AG, CH-9469 Haag, Switzerland

Copyright © VAT Vakuumentile AG 2013

No part of these instructions may be reproduced in any way (photocopies, microfilms or any other reproduction processes) nor may it be manipulated with electronic systems, duplicated or distributed without written permission from VAT. Offenders are liable to pay damages.

The original VAT firmware and updated state of the art versions of the VAT firmware are intended for use with VAT products. The VAT firmware contains a limited, time unlimited user license. The VAT firmware may not be used for purposes other than those intended nor is it permitted to make copies of the VAT firmware. In particular, it is strictly forbidden to give copies of the VAT firmware to other people.

The use of trade names, brand names, trademarks, etc. in these Instructions does not entitle third parties to consider these names to be unprotected and to use them freely. This is in accordance with the meaning of the laws and acts covering brand names and trademarks.

Contents

1	Description of product.....	5
1.1	Identification of product.....	5
1.2	Use of product.....	5
1.3	Related documents	5
1.4	Important information	5
1.5	Technical data.....	5
2	Safety	6
2.1	Compulsory reading material.....	6
2.2	Danger levels	6
2.3	Personnel qualifications	7
2.4	Safety labels.....	7
3	Design and Function.....	8
3.1	Design	8
3.2	Function	8
4	Installation	9
4.1	Unpacking	9
4.2	Installation into the system.....	10
4.2.1	Admissible forces and bending moments	11
4.3	Compressed air connection	11
4.4	Electrical connection	12
5	Operation	13
5.1	Normal operation.....	13
5.2	Operation under increased temperature	13
5.3	Behavior in case of compressed air pressure drop	13
5.4	Behavior in case of power failure.....	13
5.5	Trouble shooting	14
6	Maintenance	15
6.1	Maintenance intervals	16
6.2	Required tools	16
6.3	Replacement of vacuum seals.....	17
6.3.1	Dismount actuator / plate assembly.....	18
6.3.2	Replacement of plate seal	18
6.3.3	Mount actuator / plate assembly	18
7	Repairs	19
8	Dismounting and Storage.....	20
8.1	Dismounting	21
8.2	Storage.....	21
9	Packaging and Transport	22
9.1	Packaging	23
9.2	Transport.....	23

10	Disposal.....	24
11	Spare parts.....	25

1 Description of product

1.1 Identification of product

The fabrication number and order number are fixed on the product directly or by means of an identification plate.



← Fabrication number
← Order number

1.2 Use of product

Use product for clean and dry vacuum applications only. Other applications are only allowed with the written permission of VAT.

1.3 Related documents

- Product data sheet
- Dimensional drawing

1.4 Important information



This symbol points to a very important statement that requires particular attention.

Example:



VAT disclaims any liability for damages resulting from inappropriate packaging.

1.5 Technical data

See product data sheet and dimensional drawing.

2 Safety

2.1 Compulsory reading material

Read this chapter prior to performing any work with or on the product. It contains important information that is significant for your own personal safety. This chapter must have been read and understood by all persons who perform any kind of work with or on the product during any stage of its serviceable life.

	NOTICE
	<p>Lack of knowledge Failing to read this manual may result in property damage. Firstly, read manual.</p>



These Installation, Operating & Maintenance Instructions are an integral part of a comprehensive documentation belonging to a complete technical system. They must be stored together with the other documentation and accessible for anybody who is authorized to work with the system at any time.

2.2 Danger levels



	⚠ DANGER
	<p>High risk Indicates a hazardous situation which, if not avoided, will result in death or serious injury.</p>

	⚠ WARNING
	<p>Medium risk Indicates a hazardous situation which, if not avoided, could result in death or serious injury.</p>

	⚠ CAUTION
	<p>Low risk Indicates a hazardous situation which, if not avoided, may result in minor or moderate injury.</p>

	NOTICE
	<p>Command Indicates a hazardous situation which, if not avoided, may result in property damage.</p>

2.3 Personnel qualifications

	 WARNING
	<p>Unqualified personnel Inappropriate handling may cause serious injury or property damage. Only qualified personnel are allowed to carry out the described work.</p>

2.4 Safety labels



Label	Part No.	Location on valve
	T-9001-155	On protective covers of flanges
	253198	On valve body or actuators

Table 2-1

3 Design and Function

3.1 Design

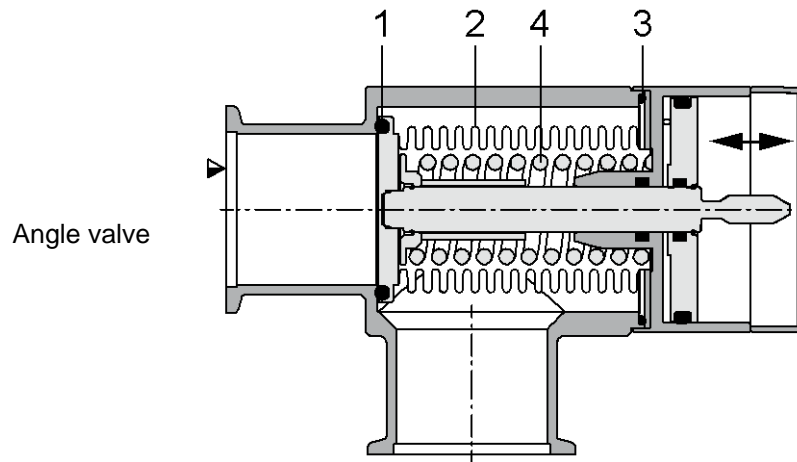

Figure 3-1

- 1 Plate seal
- 2 Bellows
- 3 Bonnet seal
- 4 Closing spring

▼ Valve seat side

- Valve body
- Actuator / plate assembly

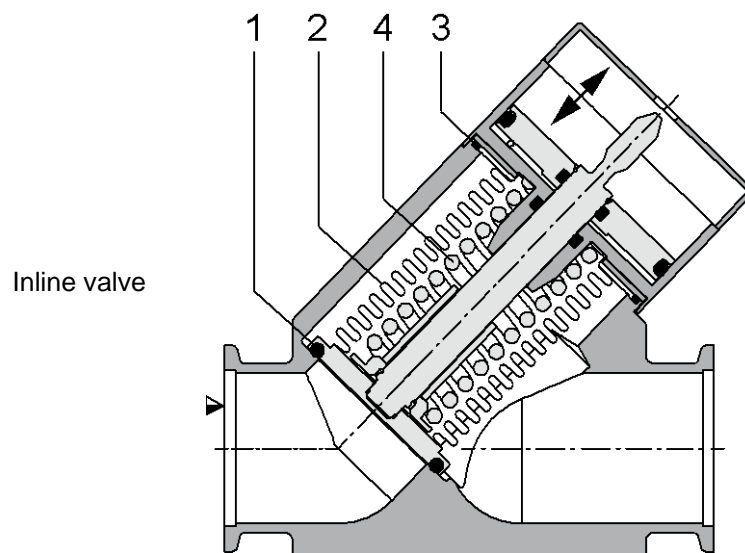



Figure 3-2

3.2 Function

Valve closes by a spring (NC) and opens pneumatically.

4 Installation

	⚠ WARNING
	<p>Unqualified personnel Inappropriate handling may cause serious injury or property damage. Only qualified personnel are allowed to carry out the described work.</p>

4.1 Unpacking







- Make sure that the supplied products are in accordance with your order.
- Inspect the quality of the supplied products visually. If it does not meet your requirements, please contact VAT immediately.
- Store the original packaging material. It may be useful if products must be returned to VAT.



Remove the protective covers from the valve only at the moment when the valve is being installed into the system. Keep unprotected sealing surfaces clean and do not damage them.

4.2 Installation into the system

	<p style="text-align: center;">⚠ CAUTION</p> <p>Valve openings Human body parts may get jammed and severely injured. Do not connect or supply electrical power and compressed air before the product is completely mounted in the system.</p>
	<p style="text-align: center;">⚠ CAUTION</p> <p>Hot surfaces Risk of burning when touching hot surfaces. Take safety measures in order that the valve cannot be touched during operation. Ensure air circulation of coil.</p>
	<p style="text-align: center;">NOTICE</p> <p>Contamination Product may get contaminated. Always wear cleanroom gloves when handling the product.</p>
	<p style="text-align: center;">NOTICE</p> <p>Inappropriate tools Sealing surfaces may get damaged. Do not use sharp-edged tools.</p>

1. Check and carefully clean sealing surfaces of valve flanges and counter flanges.
2. Install valve with connection components appropriate for ISO-KF flanges according the specification of «Table 4-1» on page 11 into account.

4.2.1 Admissible forces and bending moments

DN (nom. I. D.)		Axial tensile or compressive force «F _A »		Bending moment «M»	
mm	inch	N	lbf	Nm	lbf · ft
10	3/8	25	6	1	0.8
16	5/8	25	6	1	0.8
25	1	70	16	3	2.2
40	1½	100	22	6	4.5
50	2	150	34	11	8

A combination of both forces «F_A» and «M» is not allowed. Please contact VAT.

Angle valve

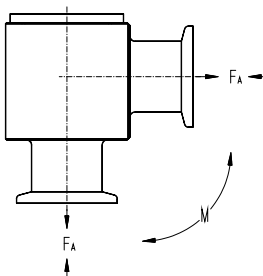

Inline valve

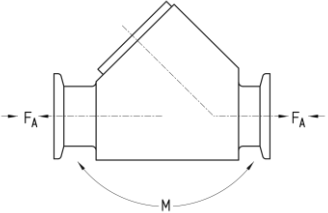



Table 4-1

4.3 Compressed air connection

⚠ CAUTION	
	<p>Valve in open position Risk of injury when connecting compressed air to the valve.</p> <p>Connect compressed air only when:</p> <ul style="list-style-type: none"> – valve is installed in the vacuum system – moving parts cannot be touched





Use clean, dry or slightly oiled air only.



Admissible air pressure range, see product data sheet.



1. Connect compressed air according to the product data sheet and dimensional drawing.

4.4 Electrical connection

	<p style="text-align: center;">⚠ DANGER</p> <p>Electric shock Parts being under voltage will result in serious injury or death. Do not touch parts being under voltage.</p>
	<p style="text-align: center;">⚠ CAUTION</p> <p>Valve in open position Risk of injury when connecting electrical power to the valve. Connect electrical power only when: – valve is installed in the vacuum system – moving parts cannot be touched.</p>
	<p style="text-align: center;">NOTICE</p> <p>Wrong voltage Electrical components may get damaged. Supply electrical components with the correct voltage.</p>

1. Connect solenoid valve according to the product data sheet and dimensional drawing.
2. Connect position indicator according to the product data sheet and dimensional drawing.
3. Connect heater (option) according to the product data sheet and dimensional drawing.

5 Operation

	<p style="text-align: center;">⚠ WARNING</p> <p>Unqualified personnel Inappropriate handling may cause serious injury or property damage. Only qualified personnel are allowed to carry out the described work.</p>
	<p style="text-align: center;">⚠ CAUTION</p> <p>Valve openings Human body parts may get jammed and severely injured. Do not operate before product is installed completely into the vacuum system.</p>
	<p style="text-align: center;">⚠ CAUTION</p> <p>Hot surfaces Risk of burning at valve with heater. Do not touch hot surfaces.</p>

5.1 Normal operation

Valve closes by a spring (NC) and opens pneumatically.

5.2 Operation under increased temperature

Maximum allowed temperature, see product data sheet.

5.3 Behavior in case of compressed air pressure drop

Valve open: Valve closes leaktight
Valve closed: Valve remains closed and leaktight

5.4 Behavior in case of power failure

Valve closes leaktight by a spring (only monostable solenoid valve).







5.5 Trouble shooting

Failure	Check	Action	See
Valve does not close / open	Compressed air connected correctly?	Check air pressure	Product data sheet
	Solenoid valve connected correctly?	Check electrical power supply and wiring	Product data sheet
No or wrong position indicator signal	Position indicator connected correctly?	Check electrical power supply and wiring	Product data sheet
Leak at plate or body	Contamination?	Clean or replace seals	Chapter «6.3 Replacement of vacuum seals»

Table 5-1

If you need any further information, please contact one of our service centers. You will find the addresses on our website www.vatvalve.com.

6 Maintenance

	<p style="text-align: center;">⚠ WARNING</p> <p>Unqualified personnel Inappropriate handling may cause serious injury or property damage. Only qualified personnel are allowed to carry out the described work.</p>
	<p style="text-align: center;">⚠ CAUTION</p> <p>Hazardous components Human body parts may get jammed and easily injured. Before starting maintenance: – disconnect compressed air supply – disconnect electrical power supply</p>
	<p style="text-align: center;">⚠ CAUTION</p> <p>Valve openings Human body parts may get jammed or easily injured. Keep human body parts away from valve openings.</p>
	<p style="text-align: center;">⚠ CAUTION</p> <p>Hot surfaces Risk of burning at valve with heater. Touch hot surfaces only if the valve has cooled down.</p>
	<p style="text-align: center;">NOTICE</p> <p>Contamination Product may get contaminated. Always wear cleanroom gloves when handling the product.</p>
	<p style="text-align: center;">NOTICE</p> <p>Inappropriate tools Sealing surfaces and valve plate may get damaged. Do not use sharp-edged tools.</p>

6.1 Maintenance intervals

Under clean operating conditions the valve does not require any maintenance during the specified cycles.

For more information or a general overhaul please contact one of our service centers. You will find the addresses on our website www.vatvalve.com.



Contamination resulting from the process may impair the function of the valve and require more frequent maintenance.

6.2 Required tools

- Allen wrench size 2.5, 3 and 5 depending on valve size
- Torque wrench according «Table 6-1» on page 18
- Cleanroom wiper soaked with alcohol (2% methyl ethyl ketone)
- O-Ring removal tool; see «Table 11-1» on page 25

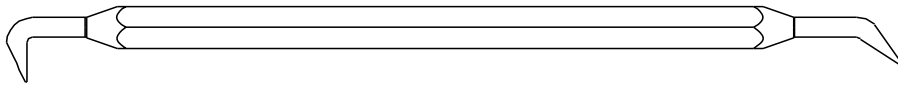

Figure 6-1

6.3 Replacement of vacuum seals

This illustration shows an angle valve. The inline valve has a different body; see «Figure 3-2» on page 8.

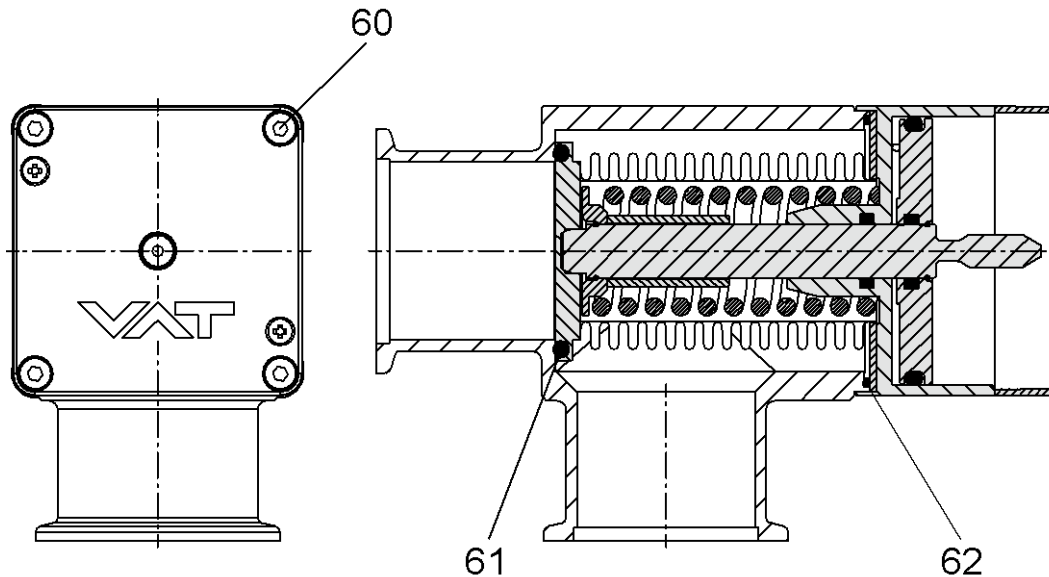



Figure 6-2

- 60 Screw
- 61 Plate seal
- 62 Bonnet seal

■ Actuator / plate assembly

6.3.1 Dismount actuator / plate assembly

	 CAUTION
	<p>Valve openings Human body parts may get jammed or easily injured. Keep human body parts away from valve openings.</p>

The item numbers in brackets refer to «Figure 6-2» on page 17.

1. Loosen and remove screws (60) uniformly and in crosswise order.
2. Withdraw actuator / plate assembly carefully from body.
3. Remove bonnet seal (62) from groove by using an O-ring removal tool.

6.3.2 Replacement of plate seal

1. Remove plate seal (61) from groove by using an O-ring removal tool.
2. Check sealing surface and clean it with a cleanroom wiper.
3. Put new plate seal (61) on groove and press it into groove at 4 opposite spots.
4. Press remaining sections uniformly into groove.

6.3.3 Mount actuator / plate assembly

1. Check sealing surfaces of bonnet flange / valve seat and clean it with a cleanroom wiper.
2. Put bonnet seal (62) into body.
3. Insert actuator / plate assembly carefully.



Do not cant.

4. Fasten screws (60) uniformly and in crosswise order, in 2 to 3 rounds.

	DN 10	DN 16	DN 25	DN 40	DN 50
Torque [Nm]	1	1	1.7	1.7	3.4

Table 6-1

Valve is ready for use.







7 Repairs

Repairs may only be carried out by the VAT service staff. In exceptional cases, the customer is allowed to carry out the repairs, but only with the prior consent of VAT.

Please contact one of our service centers. You will find the addresses on our website www.vatvalve.com.

8 Dismounting and Storage

	<p style="text-align: center;">⚠ WARNING</p> <p>Unqualified personnel Inappropriate handling may cause serious injury or property damage. Only qualified personnel are allowed to carry out the described work.</p>
	<p style="text-align: center;">⚠ CAUTION</p> <p>Hazardous components Human body parts may get jammed and easily injured. Before dismounting the product:</p> <ul style="list-style-type: none"> – disconnect compressed air supply – disconnect electrical power supply
	<p style="text-align: center;">⚠ CAUTION</p> <p>Valve openings Human body parts may get jammed or easily injured. Keep human body parts away from valve openings.</p>
	<p style="text-align: center;">⚠ CAUTION</p> <p>Hot surfaces Risk of burning at valve with heater. Touch hot surfaces only if the valve has cooled down.</p>
	<p style="text-align: center;">NOTICE</p> <p>Contamination Product may get contaminated. Always wear cleanroom gloves when handling the product.</p>

8.1 Dismounting

	NOTICE
	<p>Valve in open position Valve body and plate may get damaged if valve is in open position. Close the valve before dismantling the valve from the system.</p>

1. Disconnect compressed air supply.
2. Disconnect electrical power supply.
3. Dismount valve from system.

8.2 Storage

	NOTICE
	<p>Wrong storage Inappropriate temperatures and humidity may cause damage to the product. Valve must be stored at: – relative humidity between 10% and 70% – temperature between +10 °C and +50 °C – non-condensing environment</p>

	NOTICE
	<p>Inappropriate packaging Product may get damaged if inappropriate packaging material is used. Always use the original packaging material and handle product with care.</p>

1. Clean / decontaminate valve.
2. Cover all valve openings with protective covers or foils.
3. Pack valve appropriately, by using the original packaging material.

9 Packaging and Transport

	⚠ WARNING
	Unqualified personnel Inappropriate handling may cause serious injury or property damage. Only qualified personnel are allowed to carry out the described work.

	⚠ WARNING
	Harmful substances Risk of injury in case of contact with harmful substances. Remove harmful substances (e. g. toxic, caustic or microbiological ones) from valve before you return the valve to VAT.

	NOTICE
	Inappropriate packaging Product may get damaged if inappropriate packaging material is used. Always use the original packaging material and handle product with care.



- When returning products to VAT, please fill out the VAT form «Declaration of Chemical Contamination» and send it to VAT in advance. The form can be downloaded from our website www.vatvalve.com.
- If products are radioactively contaminated, the VAT form «Contamination and Radiation Report» must be filled out. Please contact VAT in advance.
- If products are sent to VAT in contaminated condition, VAT will carry out the decontamination procedure at the customer's expense.

9.1 Packaging

	NOTICE
	<p>Valve in open position Valve body and plate may get damaged if valve is in open position. Make sure that the valve is closed.</p>

1. Cover all valve openings with protective covers or foils.
2. Pack valve appropriately, by using the original packaging material.



VAT disclaims any liability for damages resulting from inappropriate packaging.

9.2 Transport

	NOTICE
	<p>Inappropriate packaging Product may get damaged if inappropriate packaging material is used. Always use the original packaging material and handle product with care.</p>



VAT disclaims any liability for damages resulting from inappropriate packaging.

10 Disposal

	⚠ WARNING
	Harmful substances Environmental pollution. Discard products and parts according to the local regulations.

11 Spare parts



NOTICE

Non-original spare parts

Non-original spare parts may cause damage to the product.
Use original spare parts from VAT only.



- Please specify the fabrication number of the product when you place an order for spare parts; see chapter «1.1 Identification of product». This is to ensure that the appropriate spare parts are supplied.
- VAT makes a difference between spare parts that may be replaced by the customer and those that need to be replaced by the VAT service staff.
- «Table 11-1» only contains spare parts that may be replaced by the customer. If you need any other spare parts, please contact one of our service centers. You will find the addresses on our website www.vatvalve.com.

Item	Description	Part No.	Quantity per valve	Maintenance procedure see chapter
61	Plate seal	on request	1	«6.3 Replacement of vacuum seals»
62	Bonnet seal	on request	1	
61 + 62	Seal kit	on request	1	
–	O-ring removal tool	234859	1	

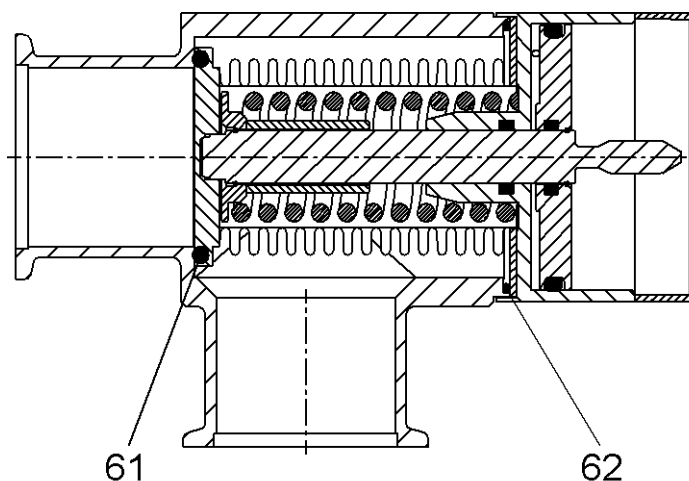

Table 11-1