



VAT Vakuumventile AG
CH-9469 Haag, Schweiz

Product data sheet

Angle valve with soft-pump function Series 290, DN 50 (ID 2") Ordering No. 29034-KA41-0003

Description

Flange		ISO-KF 50
Actuator		Pneumatic, single acting with closing spring – with solenoid valve – with position indicator
Feedthrough	– Main	Bellows
	– Soft-pump	Shaft feedthrough

Technical data

Leak rate	– Valve Body	$< 1 \cdot 10^{-9}$ mbar ls ⁻¹
	– Valve seat	$< 1 \cdot 10^{-9}$ mbar ls ⁻¹
Pressure range		$1 \cdot 10^{-8}$ mbar to 1.2 bar (abs)
Differential pressure on the plate	– In opening direction	≤ 1.2 bar
	– In closing direction	≤ 1.2 bar
Differential pressure at opening		≤ 1 bar
Conductance (molecular flow)		80 ls ⁻¹
Cycles until first service (Tmax 80 °C, under clean conditions)		2 million
Temperature (Maximum values: depending on operating conditions and sealing materials)	– Valve Body	≤ 150 °C
	– Actuator	≤ 120 °C
	– Solenoid valve	≤ 80 °C
	– Position indicator	≤ 80 °C
Material	– Valve body	Aluminum (EN AW-6082)
	– Actuator	Aluminum
	– Plate	AISI 316L (1.4435 ESU)
	– Bellows	AISI 316L (1.4404, 1.4435), AISI 316 Ti (1.4571)
Seal	– Bonnet O-ring	FKM (Viton®)
	– Plate O-ring	FKM (Viton®)
	– Feedthrough O-ring	FKM (Viton®)
	– Actuator O-ring	FKM (Viton®)
Mounting position		any
Volume of pneumatic actuator		0.047 l / 0.0017 ft ³
Compressed air min. – max. overpressure		4 – 8 bar / 58 – 116 psi
Compressed air connection		M5 female (10-32 UNF suitable)
Actuation time	– Closing	≤ 0.65 sec.
Weight		2.05 kg / 4.52 lbs

Created by: WARO	Release date: 25.08.2014	1/3
Modified by:	Release date:	765398EA



VAT Vakuumventile AG
CH-9469 Haag, Schweiz

Product data sheet

Angle valve with soft-pump function
Series 290, DN 50 (ID 2")
Ordering No. 29034-KA41-0003

Behavior in case of compressed air pressure drop

- Valve closed
- Valve opened
- During actuation

valve remains closed and leaktight
valve closes leaktight
valve closes leaktight

Behavior in case of power failure

- Valve closed
- Valve opened
- During actuation

valve remains closed and leaktight
valve closes leaktight
valve closes leaktight

Electrical connections

Solenoid valve

Type 3/2-way
Voltage See solenoid
Power See solenoid
Connector Rectangle plug, Type B (DIN standard)
Cable Ø6 – 8 mm

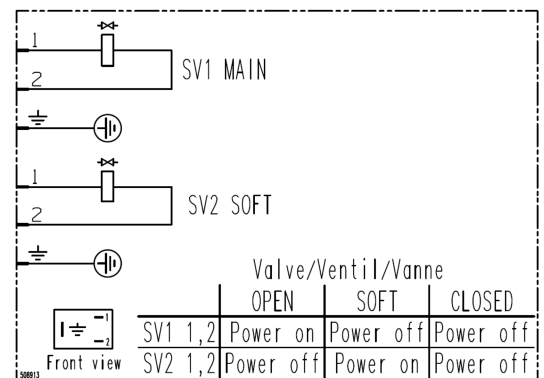

Wiring diagram

Position indicator

Type Micro switch
Voltage ≤ 50 V AC / DC
Current 5 – 100 mA
Short circuit protected No
Connection Cable, 4 wires
Cable length 500 mm
Cable cross section 0.25 mm²

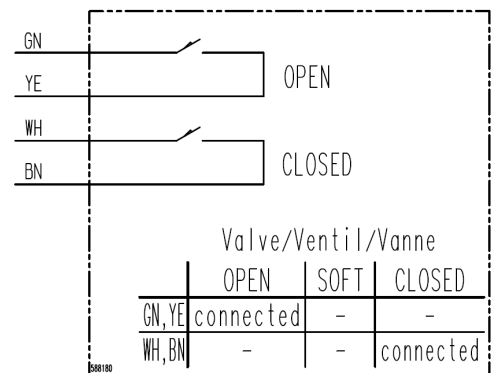

Wiring diagram



VAT Vakuumventile AG
CH-9469 Haag, Schweiz

Product data sheet

Angle valve with soft-pump function

Series 290, DN 50 (ID 2")

Ordering No. 29034-KA41-0003

conductance diagram

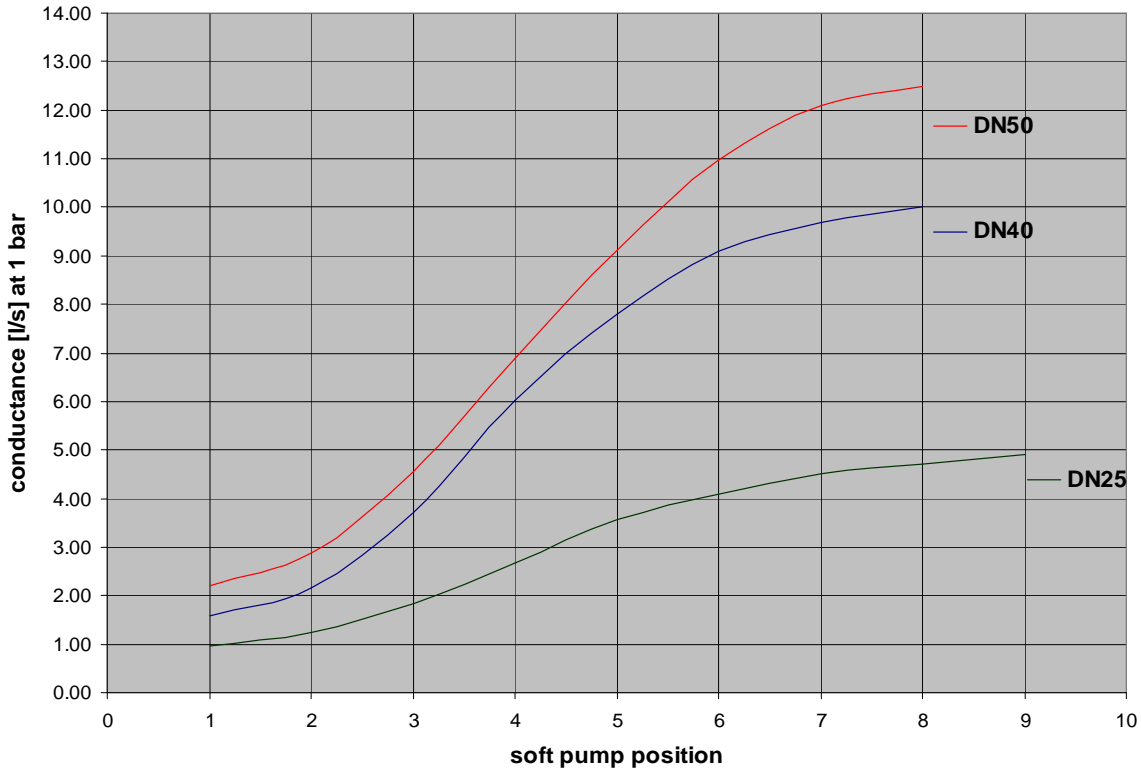

Created by: WARO	Release date: 25.08.2014	3/3
Modified by:	Release date:	765398EA