

## Angle & Inline Valve with soft-pump function with pneumatic actuator, single acting with closing spring (NC)

This manual is valid for the valve ordering number(s):

Angle valves:

29028-KA/H/E/11/21/31/41

29032-KA/H/E/11/21/31/41

29034-KA/H/E/11/21/31/41

Inline valves:

29128-KA/H/E/11/21/31/41

29132-KA/H/E/11/21/31/41

29134-KA/H/E/11/21/31/41

The fabrication number is indicated on each product as per the label below (or similar):

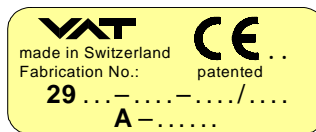
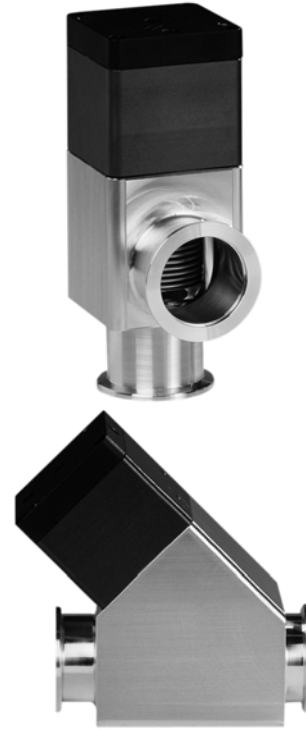

← Fabrication number

Explanation of symbols:



Read declaration carefully before you start any other action!



Keep body parts and objects away from the valve opening!



Attention!



Hot surfaces; do not touch!



Product is in conformity with EC guidelines, if applicable!



Loaded springs and/or air cushions are potential hazards!



Disconnect electrical power and compressed air lines. Do not touch parts under voltage!



Wear gloves!



Read these «**Installation, Operating & Maintenance Instructions**» and the enclosed «**General Safety Instructions**» carefully before you start any other action!



**Installation, Operating & Maintenance Instructions**  
**Series 29, DN 25 - 50 (I.D. 1" - 2")**

---

**Imprint:**

**Manufacturer** VAT Vakuumventile AG, CH-9469 Haag, Switzerland

Website  
www.vatvalve.com

Phone  
+41 81 771 61 61

Fax  
+41 81 771 48 30

Email  
CH@vatvalve.com

**Publisher** VAT Vakuumventile AG, CH-9469 Haag, Switzerland

**Editor** VAT Vakuumventile AG, CH-9469 Haag, Switzerland

**Print** VAT Vakuumventile AG, CH-9469 Haag, Switzerland

**Copyright** © VAT Vakuumventile AG 2008

No part of these Instructions may be reproduced in any way (photocopies, microfilms or any other reproduction processes) nor may it be manipulated with electronic systems, duplicated or distributed without written permission from VAT. Offenders are liable to pay damages.

The original VAT firmware and updated state of the art versions of the VAT firmware are intended for use with VAT products. The VAT firmware contains a limited, time unlimited user license. The VAT firmware may not be used for purposes other than those intended nor is it permitted to make copies of the VAT firmware. In particular, it is strictly forbidden to give copies of the VAT firmware to other people.

The use of trade names, brand names, trademarks, etc. in these Instructions does not entitle third parties to consider these names to be unprotected and to use them freely. This is in accordance with the meaning of the laws and acts covering brand names and trademarks.



**Contents:**

1	Use of product .....	4
1.1	Technical data .....	4
2	Installation .....	5
2.1	Unpacking .....	5
2.2	Installation into the system .....	5
2.3	Connections .....	5
2.3.1	Compressed air connection .....	5
2.3.2	Electrical connection .....	6
2.3.3	Position indicator options .....	7
3	Operation .....	8
3.1	Normal operation .....	8
3.2	Operating states .....	8
3.3	Operation under increased temperature .....	8
3.4	Behavior in case of compressed air pressure drop .....	8
3.5	Behavior in case of power failure .....	8
3.6	Adjustment of the soft-pump opening (intermediate position) .....	8
4	Trouble shooting .....	9
5	Maintenance & repairs .....	9
5.1	Replacement of vacuum seals .....	10
5.1.1	Dismounting of "actuator/plate assembly" .....	10
5.1.2	Replacement of plate seal .....	10
5.1.3	Replacement of plate seal (intermediate position) .....	10
5.1.4	Mounting of "actuator/plate assembly" .....	10
6	Drawing .....	11
7	Spare parts .....	12
8	Warranty .....	13



## 1 Use of product

Use product for clean and dry indoor vacuum applications under the conditions indicated in chapter «Technical data» only!  
Other applications are only allowed with the written permission of VAT.

### 1.1 Technical data

Leak rate	1 x 10 <sup>-9</sup> mbar l / s
Pressure range: valve open	1 x 10 <sup>-8</sup> mbar to 1.2 bar (abs)
Molecular flow conductance	DN 25: 14 l s <sup>-1</sup> DN 40: 45 l s <sup>-1</sup> DN 50: 80 l s <sup>-1</sup>
Differential pressure on the plate	
- in opening direction	≤ 1,2 bar
- in closing direction	≤ 1.2 bar
Differential pressure at opening	≤ 1 bar in either direction
Admissible temperature	Valve body 0° - 150°C Actuator 0° - 120°C Position indicator 0° - 80°C (Option: 120°C) Solenoid 0° - 80°C
Cycles until first service	2 million at T <sub>max</sub> 80°C
Position indicator: contact rating	Voltage 50 V AC / DC Current 0.1 A Power 1.0 VA / W
Solenoid	Voltage see specification tag on solenoid

#### Technical data for valves with options:

The appropriate «Product Data Sheet» is supplied on request

## 2 Installation

### 2.1 Unpacking

Before unpacking the valve, make sure that the packaging is in impeccable condition and the valve has not suffered damage.

**Note!** The plastic packing material and/or protective covers may only be removed immediately before the valve is mounted into the system. Unprotected sealing surfaces must be treated with care and kept clean.

### 2.2 Installation into the system

DN (nom. I.D.)		Axial tensile or compressive force «F <sub>A</sub> »		Torque moment «M»	
mm	inch	N	lbf	Nm	lbf · ft
25	1	70	16	3	2.2
40	1½	100	22	6	4.5
50	2	150	34	11	8

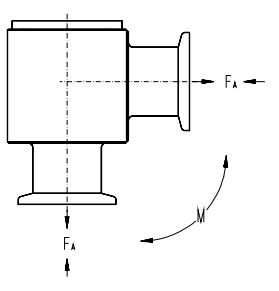
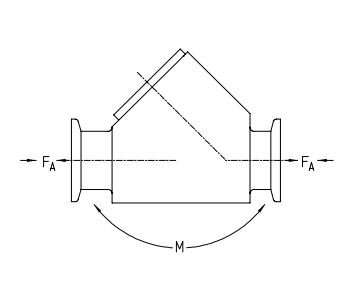
A combination of both forces «F<sub>A</sub>» and «M» is prohibited. Please contact VAT.

### 2.3 Connections

#### 2.3.1 Compressed air connection



Connect compressed air only when

- valve is installed into the system
- moving parts cannot be touched

The valve is closed by a spring when compressed air supply fails.

Connection: Internal thread M5 (Optional: R<sup>1</sup>/<sub>8</sub>" adapter or other plug connections)

Compressed air pressure (min. – max. overpressure)

DN 25: 4.5 – 7 bar / 65 – 100 psig

DN 40: 4.0 – 8 bar / 60 – 115 psig

DN 50: 4.0 – 8 bar / 60 – 115 psig

Use clean, dry or slightly oiled air only!

### 2.3.2 Electrical connection



Do not touch parts under voltage!



Hot surfaces; do not touch!



Connect electrical power only when  
 - valve is installed into the system  
 - moving parts cannot be touched

Make sure that the control voltage is in accordance with the voltage stated on the solenoid!

The plug for the solenoid is supplied with the valve.

Connections:

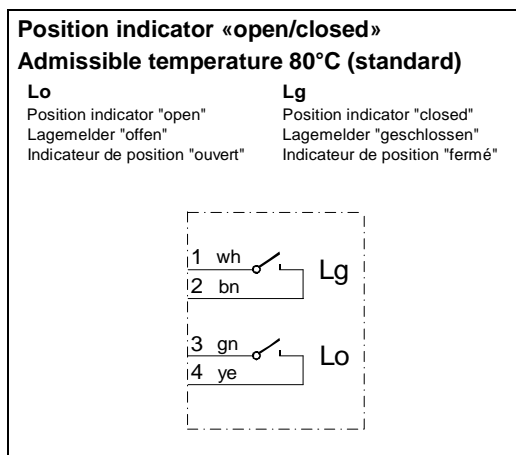
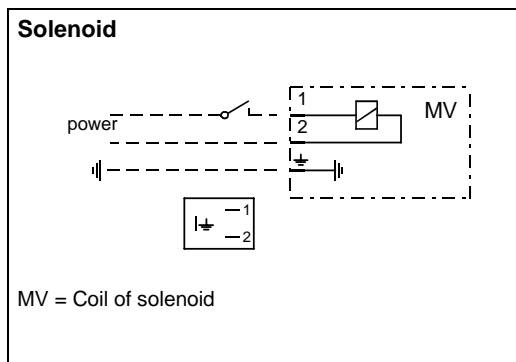

Limit switch	Lo	Lg
valve open	1	0
valve in soft pump position	0	0
valve in closed position	0	1

0 = contact open  
 1 = contact closed

2.3.3 Position indicator options

**Position indicator «open/closed»**  
**Admissible temperature 120°C (option)**

<b>Lo</b> Position indicator "open" Lagemelder "offen" Indicateur de position "ouvert"	<b>Lg</b> Position indicator "closed" Lagemelder "geschlossen" Indicateur de position "fermé"
---	--

**Plug 7 pin (standard wiring)**

<b>Lo</b> Position indicator "open" Lagemelder "offen" Indicateur de position "ouvert"	<b>Lg</b> Position indicator "closed" Lagemelder "geschlossen" Indicateur de position "fermé"
---	--

**D-sub plug 9 pin**

<b>Lo</b> Position indicator "open" Lagemelder "offen" Indicateur de position "ouvert"	<b>Lg</b> Position indicator "closed" Lagemelder "geschlossen" Indicateur de position "fermé"
---	--

Betriebsspannung  
max. 50 V DC

**M8 plug 4 pin**

<b>Lo</b> Position indicator "open" Lagemelder "offen" Indicateur de position "ouvert"	<b>Lg</b> Position indicator "closed" Lagemelder "geschlossen" Indicateur de position "fermé"
---	--

### 3 Operation

#### 3.1 Normal operation

Valve is closed by a spring (NC)  
 Valve is opened pneumatically

#### 3.2 Operating states

- No compressed air pressure: Valve is closed
- Compressed air pressure to «S»: Bypass (soft-pump opening) is open, main valve is closed
- Compressed air pressure to «M»: Main valve is open

#### 3.3 Operation under increased temperature

See «1.1 Technical data»

#### 3.4 Behavior in case of compressed air pressure drop

Valve closed: Valve remains closed and leaktight  
 Valve open: Valve closes leaktight

#### 3.5 Behavior in case of power failure

Valve with solenoid: Valve closes leaktight with of a spring  
 Valve without solenoid: Behavior is undefined — depending on the customer's installation

#### 3.6 Adjustment of the soft-pump opening (intermediate position)

The compressed air pressure at «M» and «S» must be switched off.

The rod can be turned to the desired position with an Allen wrench (Allen key).

At the lowest scale value, the conductance is minimal. By turning the rod counter-clockwise the conductance of the soft-pump opening increases. At the highest scale value, the conductance is maximal.

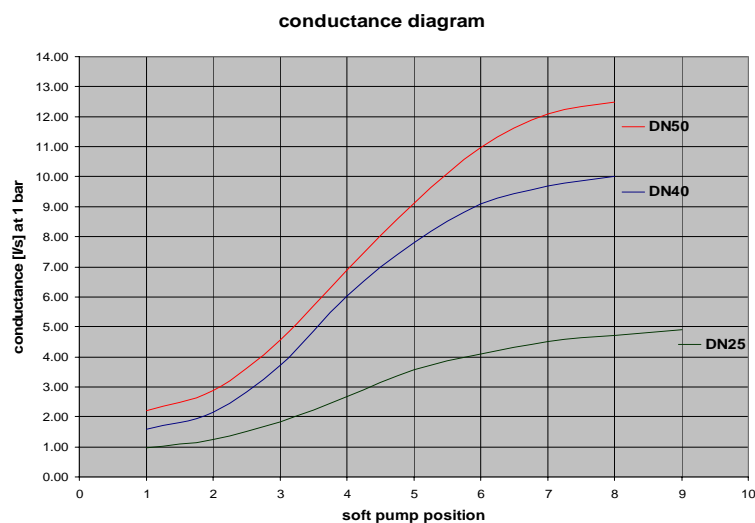





## 4 Trouble shooting

Failure	Check	Action
Valve does not open	Power available?	Connect correct voltage
	Compressed air available?	Connect correct air pressure

If you need any further information, please contact one of our service centers. You can find the addresses on our website: <http://www.vat.ch>

## 5 Maintenance & repairs

Under clean operating conditions, the valve does not require any maintenance during the specified cycle life. Contamination from the process may influence the function and requires more frequent maintenance.

Before carrying out any maintenance or repairs, please contact VAT. It has to be individually decided whether the maintenance/repair can be performed by the customer or has to be carried out by VAT. The fabrication number on the valve

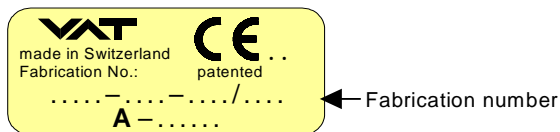

has always to be specified.

All supplies (e. g. compressed air, electrical power) must be disconnected for removal/installation of the valve from/into the system and for maintenance work.



Even with disconnected supply, loaded springs and/or air cushions in cylinders can be potential hazards.



Keep fingers and objects away from the valve opening!

Products returned to VAT must be free of harmful substances such as e.g. toxic, caustic or microbiological ones. If products are radioactively contaminated, fill in the VAT form «Contamination and Radiation Report» and send it with the product. The form is available at VAT. The maximum values indicated in the form must not be exceeded.

## 5.1 Replacement of vacuum seals

The item numbers in brackets refer to the drawing on page 11

### 5.1.1 Dismounting of "actuator/plate assembly"



- Remove 4 screws (7) uniformly and crosswise  
**Attention:** Loaded spring!
- Withdraw "actuator/plate assembly" carefully from body
- Remove bonnet seal (O-ring, 6) from groove

### 5.1.2 Replacement of plate seal

- Stick a needle into the O-ring (1) and pull it out of groove  
**Attention:** Do not damage the sealing surface!
- Check sealing surface and clean it with alcohol
- Put new O-ring (1) on plate groove and press it crosswise at 4 points into the groove
- Press O-ring uniformly into groove

### 5.1.3 Replacement of plate seal (intermediate position)

- Remove bottom plate (4)
  - DN 40 and DN 50: by removing the screws (2)
  - DN 25: by turning the bottom plate (4) with an Allen wrench (Allen key)
- Stick a needle into the O-ring (3) and pull it out of groove  
**Attention:** Do not damage the sealing surface!
- Pull O-ring (5) out of groove
- Insert new O-rings (3 + 5)
- Mount bottom plate (4)
  - DN 40 and DN 50: by inserting the screws (2)
  - DN 25: by turning the bottom plate (4) with an Allen wrench (Allen key)

### 5.1.4 Mounting of "actuator/plate assembly"

- Check and clean sealing surfaces of bonnet flange and valve seat
- Put bonnet seal (O-ring, 6) into groove
- Insert "actuator/plate assembly" carefully into body. Do not cant!
- Fasten 4 screws (7) uniformly and crosswise, in 2 to 3 steps
- Perform function and leak test

**Drawing**

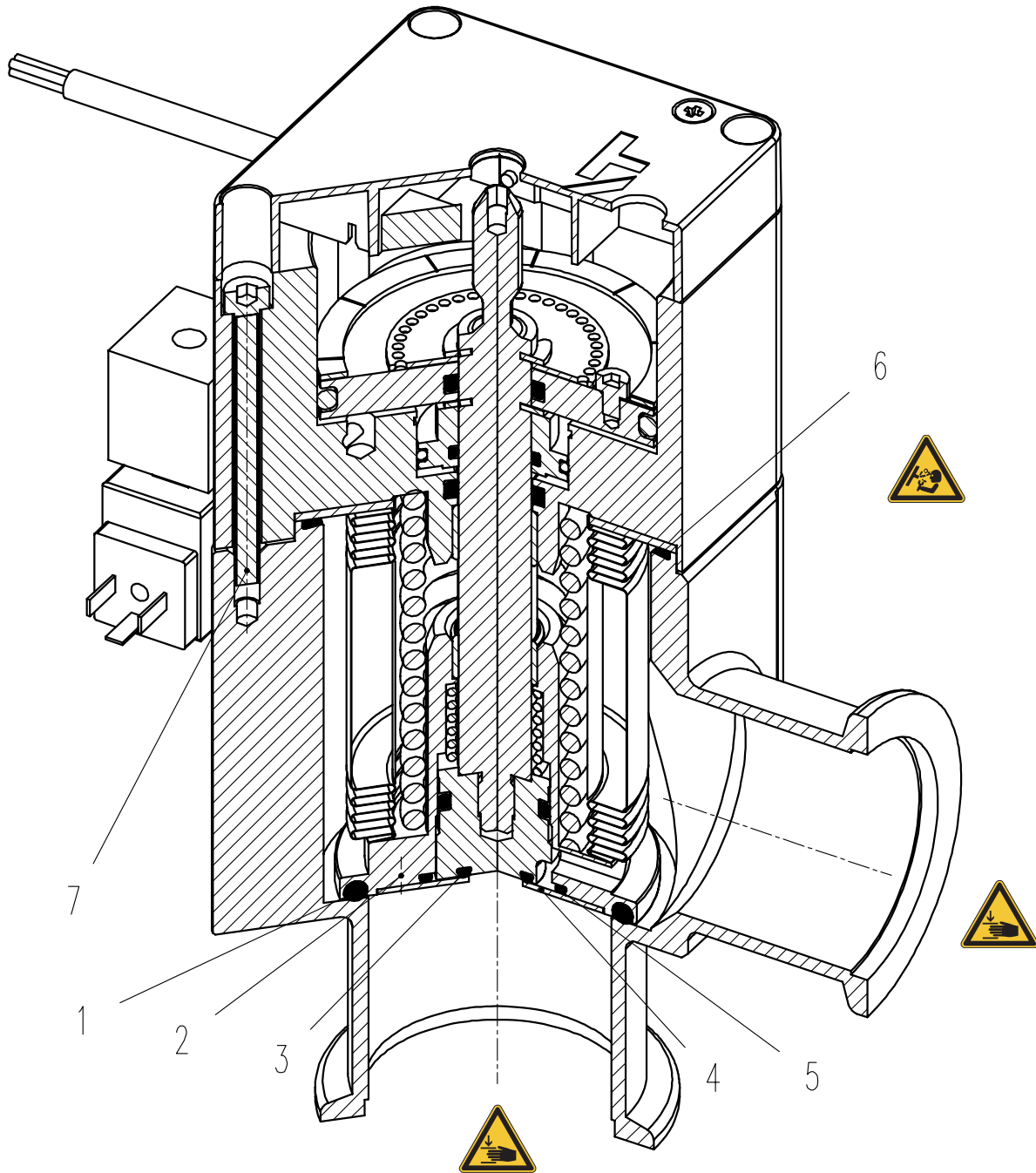

## 6 Spare parts



Please specify the **fabrication number of the valve** (see yellow label on valve) when ordering spare parts. This is to ensure that the appropriate spare parts are supplied.

Item	Description	Additional information	
1	Plate seal (O-ring)		
3	Plate seal (O-ring) for intermediate position		
4	Bottom plate		
5	Bottom seal (O-ring)		
6	Bonnet seal (O-ring)		
1, 3, 5, 6	Seal kit vacuum		
	VAT vacuum grease	N-6951-011	10 g

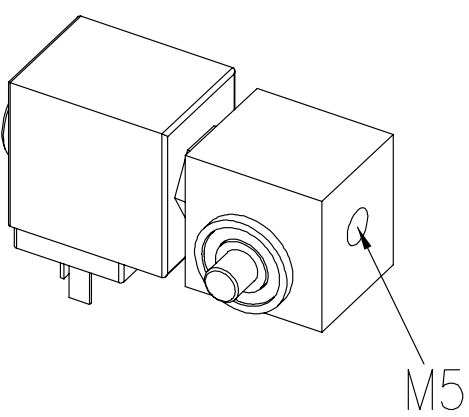
Solenoid	Item	Description	Voltage ( $\pm 10\%$ )	Ordering No.
	44	Solenoid	12 VDC	244106
			24 VDC	235683
			48 VDC	244108
			110 VDC	244118
			24 VAC / 50-60 Hz	244120
			48 VAC / 50-60 Hz	244122
			100 VAC / 50-60 Hz	244125
			115 VAC / 50-60 Hz	244127
			200 VAC / 50-60 Hz	245808
			230 VAC / 50-60 Hz	244129



## 7 Warranty

Each product sold by VAT Vakuumventile AG (VAT) is warranted to be free from the manufacturing defects that adversely affect the normal functioning thereof during the warranty period stated in VAT's «Terms of Sale» immediately following delivery thereof by VAT, provided that the same is properly operated under conditions of normal use and that regular, periodic maintenance and service is performed or replacements made, in accordance with the instructions provided by VAT. The foregoing warranty shall not apply to any product or component that has been repaired or altered by anyone other than an authorized VAT representative or that has been subject to improper installation or abuse, misuse, negligence or accident. VAT shall not be liable for any damage, loss, or expense, whether consequential, special, incidental, direct or otherwise, caused by, arising out of or connected with the manufacture, delivery (including any delay in or failure to deliver), packaging, storage or use of any product sold or delivered by VAT shall fail to conform to the foregoing warranty or to the description thereof contained herein, the purchaser thereof, as its exclusive remedy, shall upon prompt notice to VAT of any such defect or failure and upon the return of the product, part or component in question to VAT at its factory, with transportation charges prepaid, and upon VAT's inspection confirming the existence of any defect inconsistent with said warranty or any such failure, be entitled to have such defect or failure cured at VAT's factory and at no charge therefor, by replacement or repair of said product, as VAT may elect. VAT MAKES NO WARRANTY OR REPRESENTATION OF ANY KIND, EXPRESS OR IMPLIED, (INCLUDING NO WARRANTY OR MERCHANTABILITY), EXCEPT FOR THE FOREGOING WARRANTY AND THE WARRANTY THAT EACH PRODUCT SHALL CONFORM TO THE DESCRIPTION THEREOF CONTAINED HEREIN, and no warranty shall be implied by law.

Furthermore, the «Terms of sale» at the back of the price list are applicable.