



VAT Vakuumventile AG  
CH-9469 Haag, Schweiz

## Product data sheet No 269092EG

### Angle valve with soft-pump function DN 63-80 (4"-6")

#### Series 29

### Ordering No:

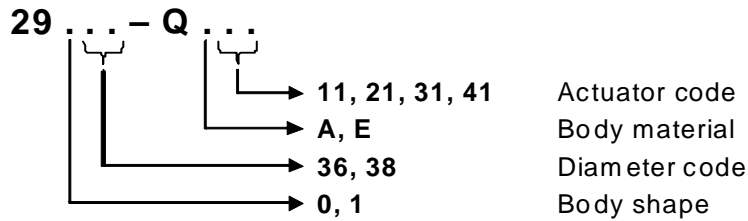

### Description

Body shape (Angle valve = 0 / Inline valve = 1)	according to dimensional drawing
Flanges	ISO-K / DN63 / DN80
Actuator	pneumatic, single acting with closing spring NC,
Feedthrough	Bellows (option: shaft feedthrough)

### Technical data

Leak rate: body and valve seat	$< 1 \cdot 10^{-9} \text{ mbar ls}^{-1}$	
Molecular flow conductance	DN 63:	$160 \text{ ls}^{-1}$
	DN 80:	$200 \text{ ls}^{-1}$
Pressure range: open and closing direction (with option: shaft feedthrough)	$1 \cdot 10^{-8} \text{ mbar}$ to 4 bar, abs $1 \cdot 10^{-7} \text{ mbar}$	
Differential pressure on the plate: in opening direction	$\leq 1.2 \text{ bar}$	
in closing direction	$\leq 4 \text{ bar}$	
Differential pressure at opening	$\leq 1 \text{ bar}$ in either direction	
Closing time	Soft pump valve	0.2 s
	Main valve	0.7 s
Admissible temperature:	-body	$\leq 120^\circ\text{C}$
	-actuator	$\leq 120^\circ\text{C}$
	-position indicator	$\leq 80^\circ\text{C}$ (option $120^\circ\text{C}$ )
Cycles until first service	3 million ( $T_{\text{max}} 80^\circ\text{C}$ , differential pressure max. 1 bar)	

Created by: G. Lutz	Release date: 2006-10-19	Page 1 of 3
Modified by: R. Walser	Release date: 2011-10-11	<b>269092EG</b>



VAT Vakuumventile AG  
CH-9469 Haag, Schweiz

## Product data sheet No 269092EG

### Angle valve with soft-pump function DN 63-80 (4"-6")

#### Series 29

Material	- Body	Soft pump valve	Aluminum Version	Stainless Steel Version
	- Plate	Main valve	AlMgSi	AISI 304 (1.4301, 1.4306)
	- Bellows		G-AlSi7Mg / AlMgSi	AISI 304 (1.4301, 1.4306)
	(option: shaft feedthrough		AISI 316L (1.4435) or AISI 304L (1.4306)	
	- Seals		AISI 316L (1.4404, 1.4435)	
			AISI 316 Ti (1.4571)	
			Aluminium)	
			Viton®	
Compressed air pressure for pneumatic			4 - 8 bar / 60 - 115 psi	
Volume of air cylinder	Soft pump valve		0.011 l / 0.0004 ft <sup>3</sup>	
	Main valve		0.112 l / 0.0040 ft <sup>3</sup>	
Mounting position			any	
Position indicator open / closed				
Contact rating			≤ 50V; ≤ 0.1A, ≤ 1.0W	
proximity switches,				
one closing contact each for the open				
and closed valve position				
Solenoid			24V / DC (option others)	
Weight	DN 63:	Aluminum Version	4.3 kg / 8.2 lbs	Stainless Steel Version
	DN 80:		3.9 kg / 8.6 lbs	6.2 kg / 13.7 lbs
				3.6 kg / 8 lbs

#### Wiring Diagrams:

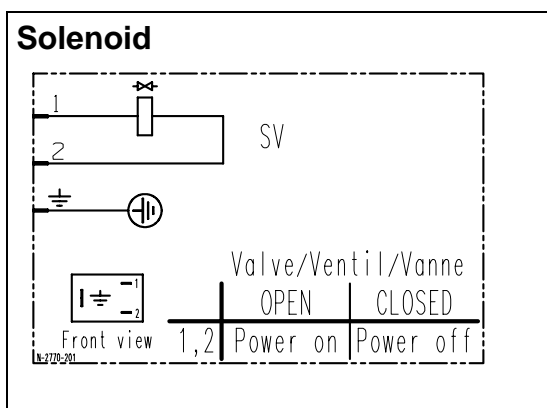

Created by: G. Lutz	Release date: 2006-10-19	Page 2 of 3
Modified by: R. Walser	Release date: 2011-10-11	<b>269092EG</b>



VAT Vakuumventile AG  
CH-9469 Haag, Schweiz

# Product data sheet No 269092EG

## Angle valve with soft-pump function DN 63-80 (4"-6")

### Series 29

#### Position indicator "open/closed", temperature resistance 80°C (standard)

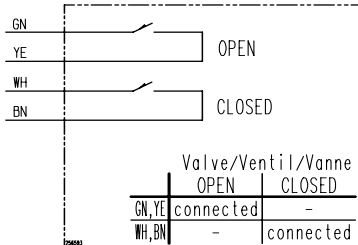

#### Position indicator "open/closed", temperature resistance 120°C (option)

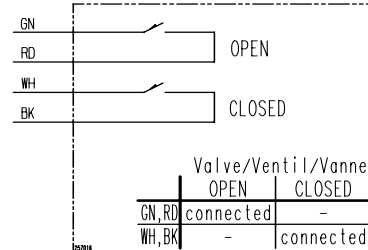

#### Position indicator with plug (option)

##### 7-pole plug (standard wiring)

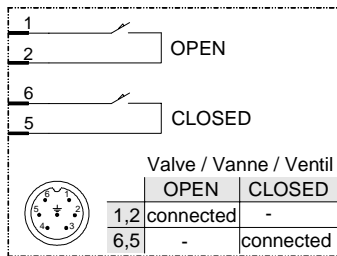

##### 9-pole D-Sub plug

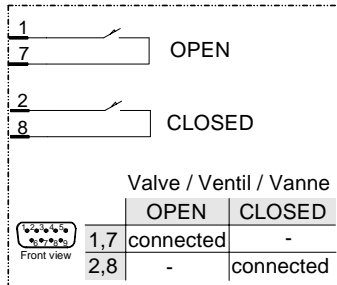

##### 4-pole plug M8

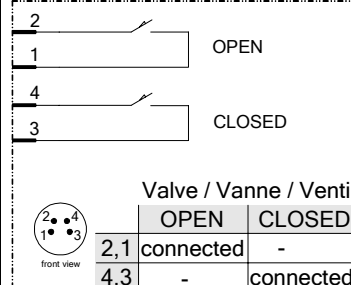

#### Common connector for solenoid and position indicator (option)

##### 7-pole plug (standard wiring)

