

This drawing is the property of VAT.

Revision

Customer number

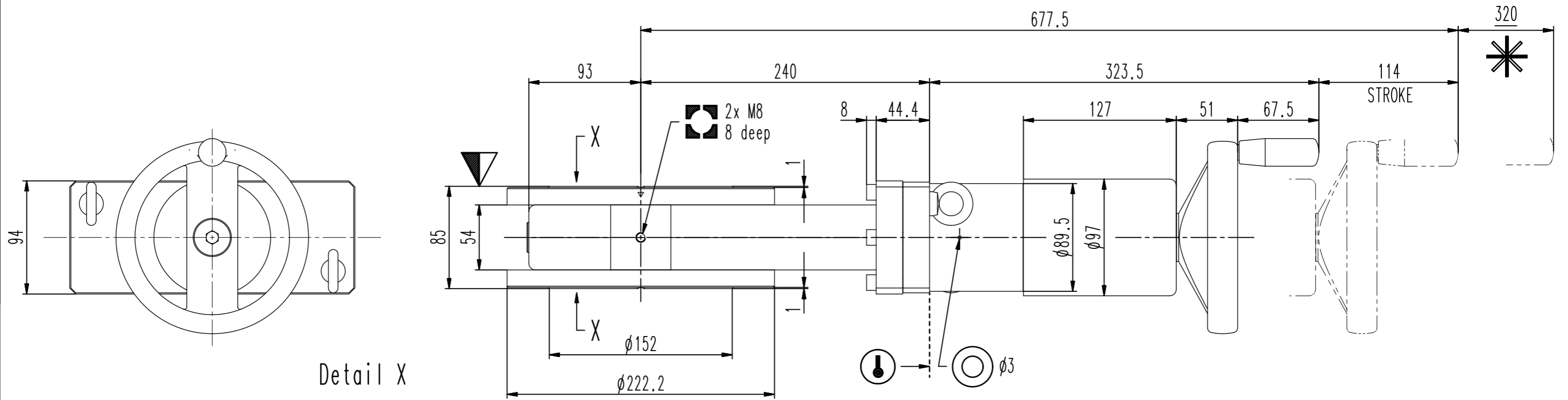

Detail X

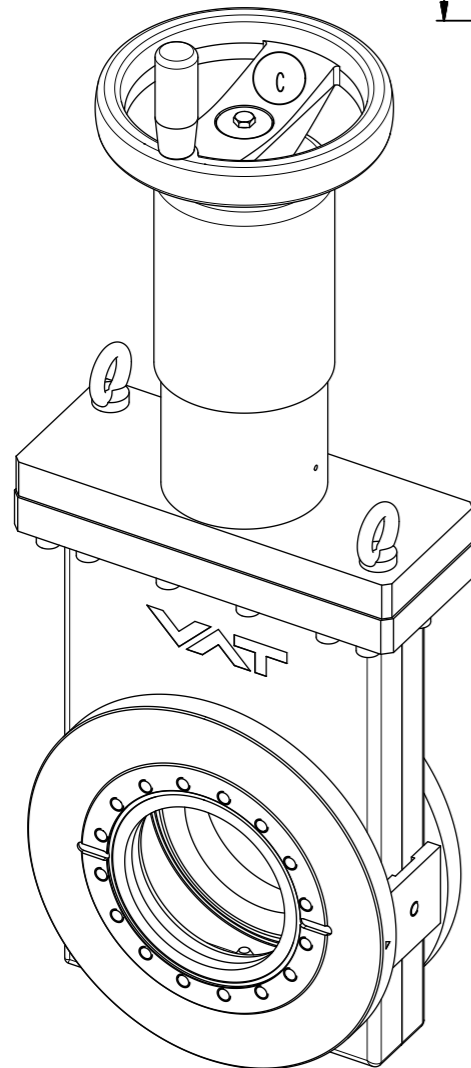
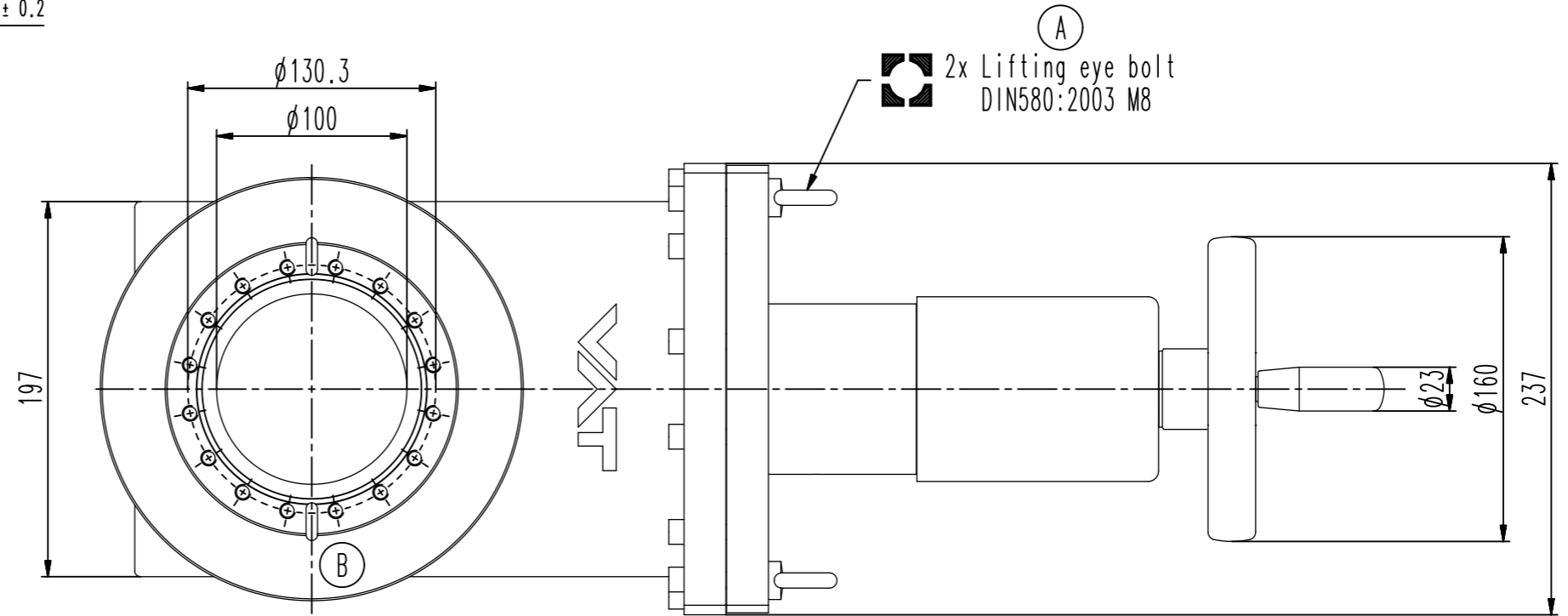
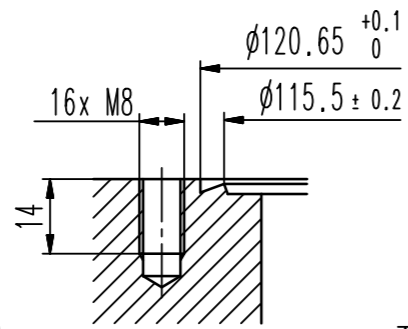

- ▼ Seat side
- ⊙ Comp. air connection
- ⊙ Electrical connection
- ⊙ Leak detection port
- ⊙ Mech. pos. indication
- ⊙ Position indicator
- ⊙ Required for dismantling
- ⊙ Emergency actuation
- ⊙ For attachment
- ⊙ Bake-out area
- ⊙ Differential pumping port

All-metal gate valve



VAT Vakuumentile AG
CH-9469 Haag, Switzerland
Tel ++41 81 7716161 Fax ++41 81 7714830

Rev.-Date: 24.09.15
Visa: MPA

Series	482	Ordering No.	48240-CE01-0003
Projection E	DN	Flange	
	100	CF-F m	
Dimensional Drawing	351275	Rev.	C