

## All-metal gate valve with compact or extended pneumatic actuator

**Series 48**  
**DN 16–320 mm (I.D. 5/8"–12")**

This manual is valid for the following product ordering numbers:

With compact actuator

48146- . E7 . - ....  
48148- . E7 . - ....  
48150- . E7 . - ....  
48236- . E7 . - ....  
48240- . E7 . - ....  
48244- . E7 . - ....

With extended actuator

48124- . E .. - ....  
48132- . E .. - ....  
48146- . E .. - ....  
48148- . E .. - ....  
48150- . E .. - ....  
48236- . E .. - ....  
48240- . E .. - ....  
48244- . E .. - ....

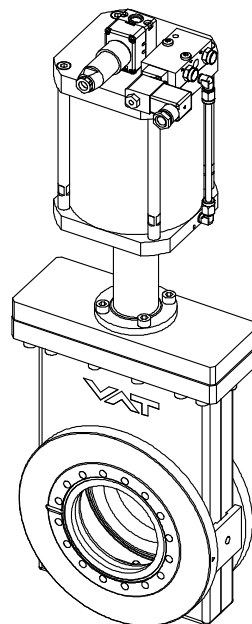
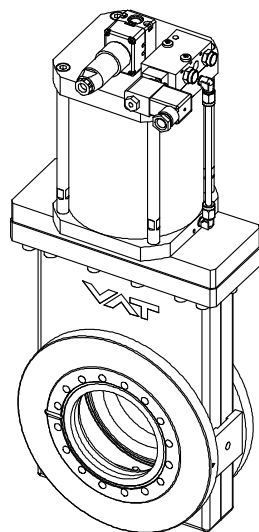

Sample pictures

## Imprint

Manufacturer VAT Vakuumventile AG, CH-9469 Haag, Switzerland

Website: [www.vatvalve.com](http://www.vatvalve.com)  
Phone: +41 81 771 61 61  
Fax: +41 81 771 48 30  
Email: [CH@vatvalve.com](mailto:CH@vatvalve.com)

Publisher VAT Vakuumventile AG, CH-9469 Haag, Switzerland

Editor VAT Vakuumventile AG, CH-9469 Haag, Switzerland

Print VAT Vakuumventile AG, CH-9469 Haag, Switzerland

Copyright © VAT Vakuumventile AG 2018

No part of these Instructions may be reproduced in any way (photocopies, microfilms or any other reproduction processes) nor may it be manipulated with electronic systems, duplicated or distributed without written permission from VAT. Offenders are liable to pay damages.

The original VAT firmware and updated state of the art versions of the VAT firmware are intended for use with VAT products. The VAT firmware contains a limited, time unlimited user license. The VAT firmware may not be used for purposes other than those intended nor is it permitted to make copies of the VAT firmware. In particular, it is strictly forbidden to give copies of the VAT firmware to other people.

The use of trade names, brand names, trademarks, etc. in these Instructions does not entitle third parties to consider these names to be unprotected and to use them freely. This is in accordance with the meaning of the laws and acts covering brand names and trademarks.

## Contents

<b>1</b>	<b>Description of product</b> .....	<b>4</b>
1.1	Identification of product.....	4
1.2	Use of product.....	4
1.3	Related documents.....	4
1.4	Important information.....	4
1.5	Technical data.....	4
<b>2</b>	<b>Safety</b> .....	<b>5</b>
2.1	Compulsory reading material.....	5
2.2	Danger levels .....	5
2.3	Personnel qualifications.....	6
2.4	Safety labels.....	6
<b>3</b>	<b>Design and Function</b> .....	<b>7</b>
3.1	Design.....	7
3.2	Function .....	8
<b>4</b>	<b>Installation</b> .....	<b>9</b>
4.1	Unpacking .....	9
4.2	Installation into the system.....	10
4.2.1	Preparation for installation .....	11
4.2.2	Mounting to the system.....	12
4.3	Compressed air connection .....	13
4.4	Electrical connection.....	14
<b>5</b>	<b>Operation</b> .....	<b>15</b>
5.1	Normal operation.....	15
5.2	Operation under increased temperature.....	16
5.3	Bake-out.....	17
5.4	Behavior in case of air pressure drop.....	17
5.5	Behavior in case of power failure .....	17
5.5.1	Manual emergency operation.....	17
5.6	Trouble shooting.....	19
<b>6</b>	<b>Maintenance</b> .....	<b>20</b>
6.1	Maintenance intervals.....	20
<b>7</b>	<b>Repairs</b> .....	<b>21</b>
<b>8</b>	<b>Dismounting and Storage</b> .....	<b>22</b>
8.1	Dismounting .....	23
8.2	Storage .....	23
<b>9</b>	<b>Packaging and Transport</b> .....	<b>24</b>
9.1	Packaging .....	25
9.2	Transport.....	25
<b>10</b>	<b>Disposal</b> .....	<b>26</b>
<b>11</b>	<b>Spare parts</b> .....	<b>27</b>

# 1 Description of product

## 1.1 Identification of product

The fabrication number and order number are fixed on the product directly or by means of an identification plate.



← Fabrication number

← Order number

## 1.2 Use of product

Use product for clean and dry vacuum applications only. Other applications are only allowed with the written permission of VAT.

## 1.3 Related documents

- Product data sheet
- Dimensional drawing

## 1.4 Important information



This symbol points to a very important statement that requires particular attention.

Example:



VAT disclaims any liability for damages resulting from inappropriate packaging.

## 1.5 Technical data

See product data sheet.

Weights of standard valves:

DN 16: 4 kg	DN 100: 27 kg	DN 250: 157 kg
DN 40: 7.5 kg	DN 160: 45 kg	DN 320: 233 kg
DN 63: 16 kg	DN 200: 87 kg	

Weight of special valves, see product data sheet.

## 2 Safety

### 2.1 Compulsory reading material

Read this chapter prior to performing any work with or on the product. It contains important information that is significant for your own personal safety. This chapter must have been read and understood by all persons who perform any kind of work with or on the product during any stage of its serviceable life.

	NOTICE
	<p><b>Lack of knowledge</b> Failing to read this manual may result in property damage. Firstly, read manual.</p>





These Installation, Operating & Maintenance Instructions are an integral part of a comprehensive documentation belonging to a complete technical system. They must be stored together with the other documentation and accessible for anybody who is authorized to work with the system at any time.

### 2.2 Danger levels



	⚠ DANGER
	<p><b>High risk</b> Indicates a hazardous situation which, if not avoided, will result in death or serious injury.</p>

	⚠ WARNING
	<p><b>Medium risk</b> Indicates a hazardous situation which, if not avoided, could result in death or serious injury.</p>

	⚠ CAUTION
	<p><b>Low risk</b> Indicates a hazardous situation which, if not avoided, may result in minor or moderate injury.</p>

	NOTICE
	<p><b>Command</b> Indicates a hazardous situation which, if not avoided, may result in property damage.</p>

### 2.3 Personnel qualifications

	 <b>WARNING</b>
	<p><b>Unqualified personnel</b>                  Inappropriate handling may cause serious injury or property damage.                  Only qualified personnel are allowed to carry out the described work.</p>

### 2.4 Safety labels

Label	Part No.	Label size (mm)	Location on valve
	DN 16–100: T-9001-155 DN 160–320: T-9001-156	20 × 20 80 × 80	On protective covers of flanges

### 3 Design and Function

#### 3.1 Design

With compact actuator:  
type 48 ... - . E7 . - ....

With extended actuator:  
type 48 ... - . E .. - ....

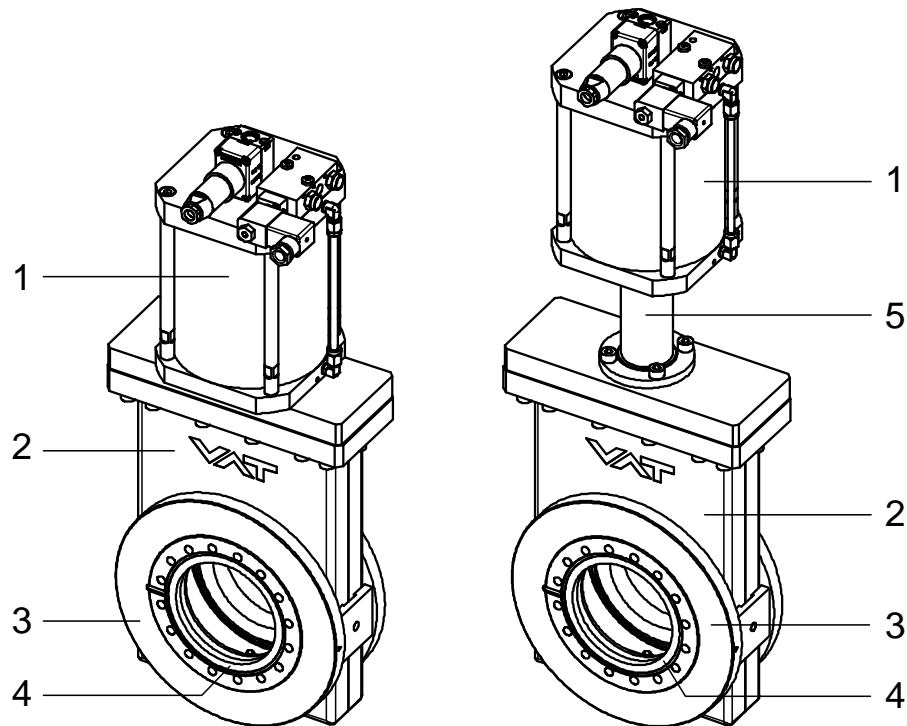

Figure 3-1

- |                     |                   |
|---------------------|-------------------|
| 1 Actuator          | 4 Sealing surface |
| 2 Valve body        | 5 Distance piece  |
| 3 Connecting flange |                   |

### 3.2 Function

Valve is closed and opened pneumatically.

Closing: The valve mechanism moves towards the valve opening until it touches the mechanical stop (4). Due to continued pressure, valve gate (1) with the assembled VATRING (7) and counter plate (2) spread apart from the guide plate (3). This effect leaktight closing.

Opening: Valve gate (1) and counter plate (2) are retracted and valve mechanism moves back into the valve body.

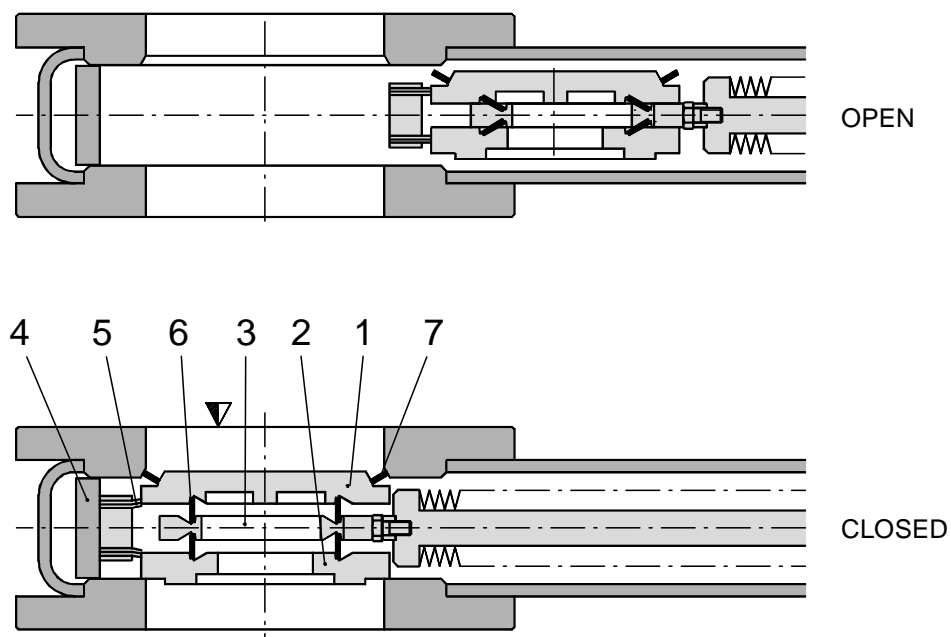



Figure 3-2

- |   |               |   |                 |
|---|---------------|---|-----------------|
| 1 | Valve gate    | 5 | Leaf spring     |
| 2 | Counter plate | 6 | Support         |
| 3 | Guide plate   | 7 | VATRING         |
| 4 | Spring stop   | ▼ | Valve seat side |



## 4 Installation

	<b>⚠ WARNING</b>
	<p><b>Unqualified personnel</b> Inappropriate handling may cause serious injury or property damage. Only qualified personnel are allowed to carry out the described work.</p>

	<b>⚠ WARNING</b>
	<p><b>Heavy weight</b> Physical overstraining. Use a crane to lift the product.</p>

### 4.1 Unpacking



- Make sure that the supplied products are in accordance with your order.
- Inspect the quality of the supplied products visually. If it does not meet your requirements, please contact VAT immediately.
- Store the original packaging material. It may be useful if products must be returned to VAT.



Open the plastic bag protecting the valve only at the points where you need access to the eyebolts (1) for fastening the crane hooks; see «Figure 4-1» on page 10. Keep valve in the plastic bag until it is being installed into the system.

	<b>NOTICE</b>
	<p><b>Wrong lifting</b> Valve may crash and get damaged. Use only the eyebolts shown in the dimensional drawing and in «Figure 4-1» on page 10 to lift the valve. Using any other components (e. g. position indicators, solenoids) to lift the valve is strictly forbidden.</p>

	<b>NOTICE</b>
	<p><b>Sensitive product</b> Valve parts may get damaged.</p> <ul style="list-style-type: none"> <li>– When lifting the valve, pay attention that the valve does not touch any solid objects.</li> <li>– Lift valve carefully and put it down on a clean surface or mount it to a clean system.</li> </ul>

Use a crane for lifting valve DN100 and higher out of the transport box; see «Figure 4-1».

Weight of standard valves; see chapter «1.5 Technical data».

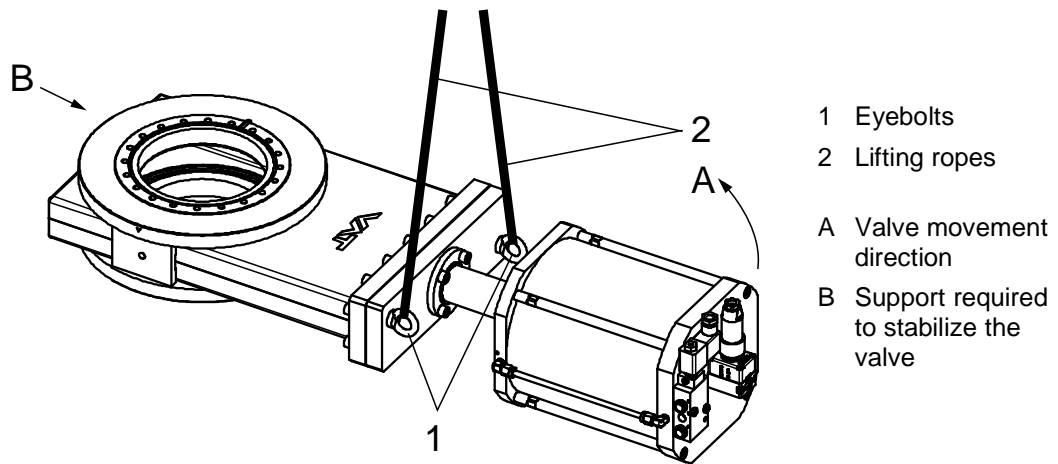



Figure 4-1

## 4.2 Installation into the system

	<p><b>⚠ WARNING</b></p>
<p><b>Movable parts</b>                  Human body parts may get jammed and severely injured.                  Do not connect or supply electrical power and compressed air before the product is completely mounted in the system.</p>	
	<p><b>NOTICE</b></p>
<p><b>Contamination</b>                  Product may get contaminated.                  Always wear cleanroom gloves when handling the product.</p>	
	<p><b>NOTICE</b></p>
<p><b>Force effect from other components of the system</b>                  Valve body may get deformed and/or malfunctions may occur.</p> <ul style="list-style-type: none"> <li>– Do not use valve to support other components.</li> <li>– Make sure that forces from other components do not impair the valve; use bellows sections, for instance.</li> </ul>	

#### 4.2.1 Preparation for installation

	<b>WARNING</b>
<p><b>Danger of injury in case of insufficient skills</b></p> <p>Inappropriate handling may cause serious injury or property damage.</p> <p>Make sure that the valve does not topple or fall down while removing the protective covers from the flanges.</p>	

	<b>NOTICE</b>
<p><b>Sensitive product</b></p> <p>Valve parts may get damaged.</p> <p>When removing the protective covers from the flanges, be careful to avoid damage to the valve.</p>	

1. Remove plastic bag.
2. Remove screws (2) and protective covers (3); see «Figure 4-2».
3. Remove O-rings (4).

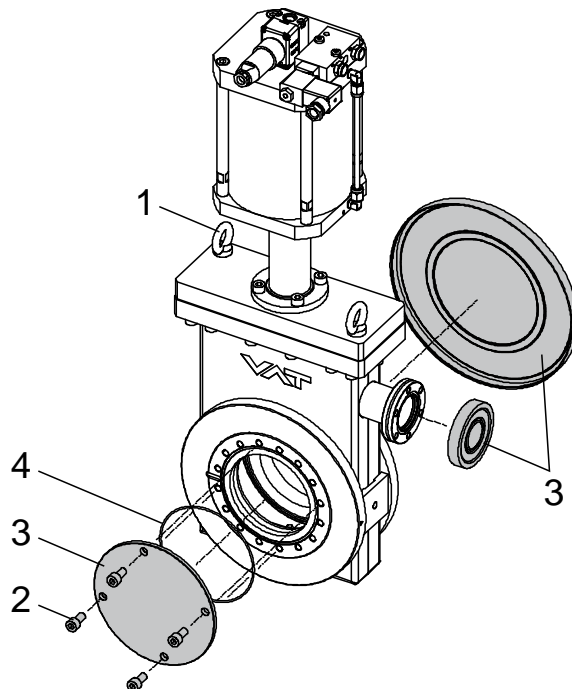

- 1 Eyebolts to fasten the crane hooks
- 2 Screws (quantity depends on valve size)
- 3 Protective covers
- 4 O-rings

Figure 4-2



Store screws, protective covers and O-rings. They may be useful when valve needs to be repacked.

4. Clean sealing surfaces; see «Figure 3-1» on page 7, with a cleanroom wiper soaked with pure alcohol (Isopropanol).
5. Clean surface with clean, oil free compressed air.

#### 4.2.2 Mounting to the system



The valve seat side is marked with the symbol «∇» on flange «A»; see «Figure 4-3».

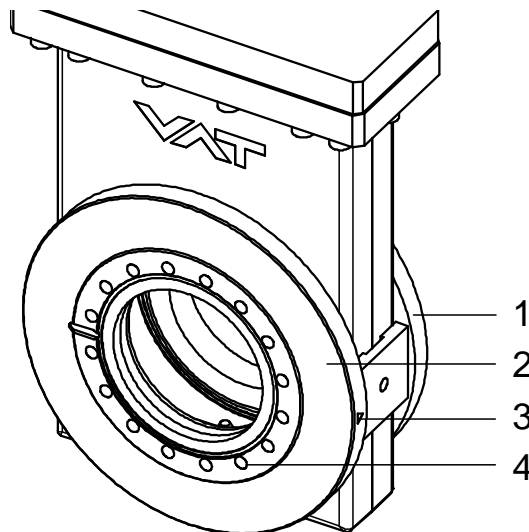

1. Mount valve to your system by using appropriate flange screws (different quantity of screws required – depending on valve size).
2. Initially, mount four screws evenly in crosswise order until the seal touches the sealing surface.
3. Afterwards, mount all screws evenly in crosswise order.
4. Tighten all screws with the torques appropriate for the property classes of the screws.



- 1 Flange B
- 2 Flange A
- 3 Marking for valve seat side (symbol «∇»)
- 4 Screw holes

Figure 4-3

### 4.3 Compressed air connection

 <b>WARNING</b>	
	<p><b>Valve in open or closed position</b></p> <p>Risk of injury when compressed air is connected to the valve.</p> <p>Connect compressed air only when:</p> <ul style="list-style-type: none"> <li>- valve is installed in the vacuum system</li> <li>- moving parts cannot be touched</li> </ul>

<b>NOTICE</b>	
	<p><b>Wrong sequence of connections</b></p> <p>Valve mechanism may get damaged when electrical power is being connected before compressed air is connected.</p> <p>Always connect compressed air before connecting electrical power.</p>



Use clean, dry or slightly oiled air only.



Admissible air pressure range, see product data sheet.



Supply compressed air pressure only after the supply line is properly mounted to the actuator.

1. Connect compressed air supply line according the specification on the product data sheet and; see «Table 4-1».

Execution	Procedure
<p><b>Without solenoid valve</b></p> <p>48 ... - . E14- ....</p> <p>48 ... - . E24- ....</p> <p>48 ... - . E72- ....</p>	<p>Connect relevant compressed air line to connection ☉ CLOSE.</p> <p>Afterwards, connect relevant compressed air line to connection ☉ OPEN.</p> <p><b>Supply admissible compressed air to connection “close” first!</b></p>
<p><b>Standard solenoid valve</b></p> <p>48 ... - . E44- ....</p> <p>48 ... - . E74- ....</p>	<p>Connect relevant compressed air supply line to connection ☉ OPEN/CLOSE.</p> <p>Supply admissible compressed air to connection “open/close”.</p>
<p><b>Impulse solenoid valve (option)</b></p> <p>48 ... - . E44- ....</p> <p>48 ... - . E74- ....</p>	<p>Connect relevant compressed air supply line to connection ☉ OPEN/CLOSE.</p> <p>Supply admissible compressed air to connection “open/close”.</p>

Table 4-1

#### 4.4 Electrical connection

	⚠ DANGER
	<p><b>Electric shock</b></p> <p>Parts being under voltage will result in serious injury or death. Do not touch parts being under voltage.</p>

	NOTICE
	<p><b>Wrong sequence of connections</b></p> <p>Valve mechanism may get damaged when electrical power is being connected before compressed air is connected. Always connect compressed air before connecting electrical power.</p>



	NOTICE
	<p><b>Wrong voltage</b></p> <p>Electrical components may get damaged. Supply electrical components with the correct voltage.</p>



1. Connect position indicator according to product data sheet.
2. Connect the contacts of the solenoid valve connector according to the wiring diagram on the product data sheet, specification on solenoid coil and; see «Table 4-2».

Execution	Procedure
<p><b>Without solenoid valve</b></p> <p>48 ... - . E14- .... 48 ... - . E24- .... 48 ... - . E72- ....</p>	n. a.
<p><b>Standard solenoid valve</b></p> <p>48 ... - . E44- .... 48 ... - . E74- ....</p>	Connect one connector to the magnetic coil.
<p><b>Impulse solenoid valve (option)</b></p> <p>48 ... - . E44- .... 48 ... - . E74- ....</p>	Connect the relevant connector to the open and close magnetic coil.

Table 4-2

## 5 Operation

	 <b>WARNING</b>
	<p><b>Unqualified personnel</b></p> <p>Inappropriate handling may cause serious injury or property damage. Only qualified personnel are allowed to carry out the described work.</p>

	 <b>WARNING</b>
	<p><b>Movable parts</b></p> <p>Human body parts may get jammed and severely injured. Do not operate before product is installed completely into the vacuum system.</p>

### 5.1 Normal operation

Valve is closed and opened pneumatically.



For technical details, see product data sheet.



Make sure that compressed air is supplied at the specified pressure; see also chapter «4.3 Compressed air connection».



Make sure that the connect voltage is supplied.  
Check voltage specification on coil; see also chapter «4.4 Electrical connection».

Action	Execution	Procedure
To open the valve	<p><b>Without solenoid valve</b></p> <p>48 ... - . E14- .... 48 ... - . E24- .... 48 ... - . E72- ....</p>	Supply compressed air to connection “open”. Release air through connection “closed”.
	<p><b>Standard solenoid valve</b></p> <p>48 ... - . E44- .... 48 ... - . E74- ....</p>	Supply specified voltage to the magnetic coil.
	<p><b>Impulse solenoid valve (option)</b></p> <p>48 ... - . E44- .... 48 ... - . E74- ....</p>	Supply an impulse of specified voltage to the coil for opening (pulse duration min. 50 ms).

Table 5-1

Action	Execution	Procedure
To close the valve	<b>Without solenoid valve</b> 48 ... - . E14- .... 48 ... - . E24- .... 48 ... - . E72- ....	Supply compressed air to connection "close". Release air through connection "open".
	<b>Standard solenoid valve</b> 48 ... - . E44- .... 48 ... - . E74- ....	Cut voltage supply to the magnetic coil.
	<b>Impulse solenoid valve (option)</b> 48 ... - . E44- .... 48 ... - . E74- ....	Supply an impulse of specified voltage to the coil for closing (pulse duration min. 50 ms).

Table 5-2

## 5.2 Operation under increased temperature

Maximum allowed temperature, see product data sheet.

<b>NOTICE</b>	
	<p><b>Inconstant temperatures</b></p> <p>Performance of the valve may deteriorate.</p> <ul style="list-style-type: none"> <li>– Actuate valve only after the bake-out temperature has been stable for two hours.</li> <li>– If valve must be actuated during bake-out, make sure that the heating or cooling rate does not exceed 10 °C per hour in the temperature range from 100 °C to 200 °C (version with compact actuator). from 100 °C to 300 °C (version with extended actuator).</li> <li>– Make sure that the temperature differences over the whole body do not exceed 30 °C.</li> </ul>



### 5.3 Bake-out



Inside under vacuum pressure  $\leq 10^{-5}$  mbar to prevent oxidation.

		compact	extended
Valve:		$\leq 200$ °C in open and closed position	$\leq 300$ °C in open and closed position
Actuator:	standard:	$\leq 200$ °C for max.100 h *	$\leq 200$ °C for max.100 h *
	option: $10^6$ Gy ( $10^8$ rad)	$\leq 140$ °C for max.100 h *	$\leq 140$ °C for max.100 h *
	option: $10^8$ Gy ( $10^{10}$ rad)	$\leq 200$ °C *	$\leq 200$ °C *
Position indicator:	standard:	$\leq 80$ °C	$\leq 80$ °C
	option: 200 °C	$\leq 200$ °C	$\leq 200$ °C
Solenoid:		$\leq 80$ °C	$\leq 80$ °C
Heating and cooling rate:			
DN 16– 40		–	$\leq 80$ °C / h
DN 63–160		$\leq 50$ °C / h	$\leq 50$ °C / h
DN 200–320		$\leq 25$ °C / h	$\leq 25$ °C / h

Table 5-3

\* Applied high temperatures and radiation exposure are weakening the sealing materials of the actuator. A combination of both will shorten the lifetime.

### 5.4 Behavior in case of air pressure drop

Valve closed: Valve remains closed and leaktight.

Valve open: Valve position is undefined.  
Option – actuator mechanically locked in position open:  
Valve remains open.

### 5.5 Behavior in case of power failure

Standard solenoid: Valve closes.

Impulse solenoid (option): Valve position does not change. A started movement will continue to the end.

#### 5.5.1 Manual emergency operation



#### **WARNING**

##### **Movable parts**

Human body parts may get jammed and severely injured.

Keep human body parts away from movable parts.

The solenoids are provided with manual emergency operation (slotted screw). This screw allows actuating the valve in case of a power failure. Compressed air must be supplied!

**Standard solenoid**

To close the valve: Turn the slotted screw (1) counter-clockwise to its stop.

To open the valve: Turn the slotted screw (1) clockwise to its stop.

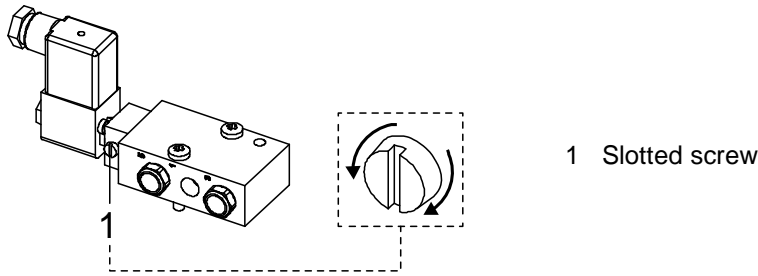

Figure 5-1

For remote operation make sure that the slotted screw is turned counter-clockwise to its stop.

**Impulse solenoid**

To close the valve: Turn the slotted screw (3) – coil CLOSE – clockwise to its stop. As soon as valve is closed, turn screw back to its original position.

To open the valve: Turn the slotted screw (2) – coil OPEN – clockwise to its stop. As soon as valve is open, turn screw back to its original position.

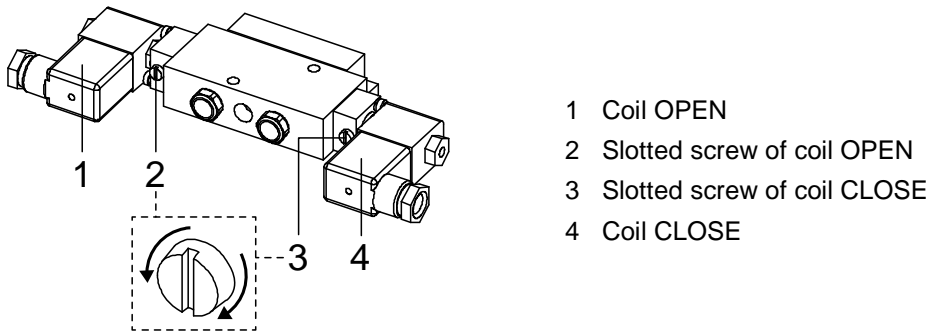

Figure 5-2

For remote operation make sure that both slotted screws are turned counter-clockwise to their stop (original position).

## 5.6 Trouble shooting

Failure	Check	Action	See
Valve mechanism does not move	Air pressure	Connect compressed air	«4.3 Compressed air connection»
	Electrical power	Connect electrical power	«4.4 Electrical connection»
	Operating pressure	Adjust operating pressure	«4.3 Compressed air connection»
	Position of slotted screw	Turn slotted screw to the correct position	«5.5.1 Manual emergency operation»
Leak at gate	Condition of gate seal	Please contact VAT	<a href="http://www.vatvalve.com">www.vatvalve.com</a>
	Condition of valve gate	Please contact VAT	<a href="http://www.vatvalve.com">www.vatvalve.com</a>
	Operating pressure	Adjust operating pressure	«4.3 Compressed air connection»
Leak at body	Condition of bonnet seal and sealing surface	Please contact VAT	<a href="http://www.vatvalve.com">www.vatvalve.com</a>
	Condition of bellows	Please contact VAT	<a href="http://www.vatvalve.com">www.vatvalve.com</a>
Whistling sound during opening or closing	–	No action required when valve is actuated at atmosphere	–
	–	No action required when valve is actuated in vacuum as long as the sound is not excessive	–

Table 5-4

If you need any further information, please contact one of our service centers. You will find the addresses on our website [www.vatvalve.com](http://www.vatvalve.com).

## 6 Maintenance

	<b>⚠ WARNING</b>
	<b>Unqualified personnel</b> Inappropriate handling may cause serious injury or property damage. Only qualified personnel are allowed to carry out the described work.

### 6.1 Maintenance intervals

Under clean operating conditions the valve does not require any maintenance during the specified life cycle.







- Impacts from the process may require more frequent maintenance.
- When the valve has reached the specified life cycle; see product data sheet, we recommend to have it serviced by VAT. Please contact your nearest VAT service center to get recommendations and an offer. You will find the addresses on our website [www.vatvalve.com](http://www.vatvalve.com).

## 7 Repairs

Repairs may only be carried out by the VAT service staff. In exceptional cases, the customer is allowed to carry out the repairs, but only with the prior consent of VAT.

Please contact one of our service centers. You will find the addresses on our website [www.vatvalve.com](http://www.vatvalve.com).

## 8 Dismounting and Storage

	<p style="text-align: center;"><b>⚠ WARNING</b></p> <p><b>Unqualified personnel</b>          Inappropriate handling may cause serious injury or property damage.          Only qualified personnel are allowed to carry out the described work.</p>
	<p style="text-align: center;"><b>⚠ WARNING</b></p> <p><b>Heavy weight</b>          Physical overstraining.          Use a crane to lift the product.</p>
	<p style="text-align: center;"><b>⚠ WARNING</b></p> <p><b>Hazardous components</b>          Human body parts may get jammed and severely injured.          Before dismounting the product:</p> <ul style="list-style-type: none"> <li>– disconnect compressed air supply</li> <li>– disconnect electrical power supply</li> </ul>
	<p style="text-align: center;"><b>⚠ WARNING</b></p> <p><b>Movable parts</b>          Human body parts may get jammed and severely injured.          Keep human body parts away from movable parts.</p>
	<p style="text-align: center;"><b>NOTICE</b></p> <p><b>Contamination</b>          Product may get contaminated.          Always wear cleanroom gloves when handling the product.</p>

## 8.1 Dismounting

<b>NOTICE</b>	
	<p><b>Valve in open position</b> Valve mechanism may get damaged if valve is in open position. Close valve before dismounting the valve from the system.</p>

1. Close valve.
2. Disconnect compressed air supply.



After disconnecting the compressed air, make sure that the actuator is depressurized!

3. Disconnect electrical power supply.
4. Dismount valve according chapter «4 Installation», however in reverse order.



Observe safety instruction of chapter «4 Installation».





## 8.2 Storage

<b>NOTICE</b>	
	<p><b>Wrong storage</b> Inappropriate temperatures and humidity may cause damage to the product. Valve must be stored at: – relative humidity between 10% and 70% – temperature between +10 °C and +50 °C – non-condensing environment</p>

<b>NOTICE</b>	
	<p><b>Inappropriate packaging</b> Product may get damaged if inappropriate packaging material is used. Always use the original packaging material and handle product with care.</p>

1. Clean / decontaminate valve.
2. Mount protective covers on flanges; see chapter «4.2.1 Preparation for installation».
3. Pack valve appropriately, by using the original packaging material.

## 9 Packaging and Transport

	<p style="text-align: center;"><b>⚠ WARNING</b></p> <p><b>Unqualified personnel</b>                  Inappropriate handling may cause serious injury or property damage.                  Only qualified personnel are allowed to carry out the described work.</p>
	<p style="text-align: center;"><b>⚠ WARNING</b></p> <p><b>Harmful substances</b>                  Risk of injury in case of contact with harmful substances.                  Remove harmful substances (e. g. toxic, caustic or microbiological ones) from valve before you return the valve to VAT.</p>
	<p style="text-align: center;"><b>⚠ WARNING</b></p> <p><b>Heavy weight</b>                  Physical overstraining.                  Use a crane to lift the product.</p>
	<p style="text-align: center;"><b>NOTICE</b></p> <p><b>Inappropriate packaging</b>                  Product may get damaged if inappropriate packaging material is used.                  Always use the original packaging material and handle product with care.</p>



- When returning products to VAT, please fill out the VAT form «Declaration of Chemical Contamination» and send it to VAT in advance. The form can be downloaded from our website [www.vatvalve.com](http://www.vatvalve.com).
- If products are radioactively contaminated, the VAT form «Contamination and Radiation Report» must be filled out. Please contact VAT in advance.
- If products are sent to VAT in contaminated condition, VAT will carry out the decontamination procedure at the customer's expense.



## 9.1 Packaging

<b>NOTICE</b>	
	<p><b>Valve in open position</b> Valve mechanism may get damaged if valve is in open position. Make sure that the valve is closed.</p>

1. Mount protective covers on flanges; see chapter «4.2.1 Preparation for installation».
2. Pack valve appropriately, by using the original packaging material.



VAT disclaims any liability for damages resulting from inappropriate packaging.

## 9.2 Transport

<b>NOTICE</b>	
	<p><b>Inappropriate packaging</b> Product may get damaged if inappropriate packaging material is used. Always use the original packaging material and handle product with care.</p>



VAT disclaims any liability for damages resulting from inappropriate packaging.

## 10 Disposal

	<b>⚠ WARNING</b>
	<b>Harmful substances</b> Environmental pollution. Discard products and parts according to the local regulations.

## 11 Spare parts



### **NOTICE**

#### **Non-original spare parts**

Non-original spare parts may cause damage to the product.  
Use original spare parts from VAT only.



- Parts may only be replaced by the VAT service staff.
- Please contact one of our service centers and specify the fabrication number of the product; see chapter «1.1 Identification of product». You will find the addresses on our website [www.vatvalve.com](http://www.vatvalve.com).