

## All-metal angle valve with manual actuator

**Series 570**

**DN 63 - 160 mm (I. D. 2<sup>1/2</sup> - 6")**

This manual is valid for the following product ordering numbers:

**57036-.E02/05/07/08**

**57040-.E02/05/07/08**

**57044-.E02/05/07/08**

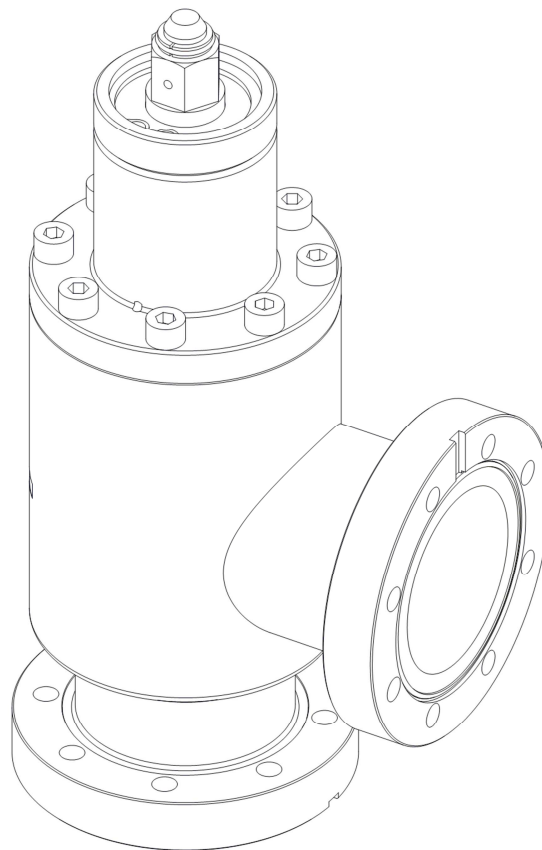

Sample picture

## Imprint

Manufacturer VAT Vakuumventile AG, CH-9469 Haag, Switzerland

Website: [www.vatvalve.com](http://www.vatvalve.com)  
Phone: +41 81 771 61 61  
Fax: +41 81 771 48 30  
Email: [CH@vatvalve.com](mailto:CH@vatvalve.com)

Publisher VAT Vakuumventile AG, CH-9469 Haag, Switzerland

Editor VAT Vakuumventile AG, CH-9469 Haag, Switzerland

Print VAT Vakuumventile AG, CH-9469 Haag, Switzerland

Copyright © VAT Vakuumventile AG 2019

No part of these Instructions may be reproduced in any way (photocopies, microfilms or any other reproduction processes) nor may it be manipulated with electronic systems, duplicated or distributed without written permission from VAT. Offenders are liable to pay damages.

The original VAT firmware and updated state of the art versions of the VAT firmware are intended for use with VAT products. The VAT firmware contains a limited, time unlimited user license. The VAT firmware may not be used for purposes other than those intended nor is it permitted to make copies of the VAT firmware. In particular, it is strictly forbidden to give copies of the VAT firmware to other people.

The use of trade names, brand names, trademarks, etc. in these Instructions does not entitle third parties to consider these names to be unprotected and to use them freely. This is in accordance with the meaning of the laws and acts covering brand names and trademarks.

## Contents

<b>1</b>	<b>Description of product.....</b>	<b>5</b>
1.1	Identification of product.....	5
1.2	Use of product.....	5
1.3	Related documents .....	5
1.4	Important information .....	5
1.5	Technical data.....	5
<b>2</b>	<b>Safety .....</b>	<b>6</b>
2.1	Compulsory reading material .....	6
2.2	Danger levels .....	6
2.3	Personnel qualifications .....	7
2.4	Safety labels.....	7
<b>3</b>	<b>Design and Function.....</b>	<b>8</b>
3.1	Design .....	8
3.2	Function .....	9
<b>4</b>	<b>Installation .....</b>	<b>10</b>
4.1	Unpacking .....	10
4.2	Installation into the system.....	11
4.2.1	Preparation for installation .....	12
4.2.2	Mounting to the system .....	13
4.2.2.1	Leak detection port .....	13
4.3	Electrical connection .....	14
4.3.1	Position indicators.....	15
4.3.1.1	Wiring diagrams:.....	15
<b>5</b>	<b>Operation .....</b>	<b>16</b>
5.1	Normal operation.....	16
5.2	Operation under increased temperature .....	17
5.3	Bake-out.....	17
<b>6</b>	<b>Trouble shooting.....</b>	<b>18</b>
<b>7</b>	<b>Maintenance .....</b>	<b>19</b>
7.1	Maintenance intervals .....	19
7.2	Preventive Maintenance .....	19
7.3	Re-greasing of actuator shaft:.....	20
7.4	Replacement of dynamic seal VATRING.....	20
7.5	Drawing .....	21
<b>8</b>	<b>Repairs .....</b>	<b>22</b>
<b>9</b>	<b>Dismounting and Storage.....</b>	<b>23</b>
9.1	Dismounting .....	23
9.2	Storage.....	24
<b>10</b>	<b>Packaging and Transport .....</b>	<b>25</b>
10.1	Packaging .....	26
10.2	Transport.....	26

<b>11</b>	<b>Disposal</b> .....	<b>27</b>
<b>12</b>	<b>Spare parts</b> .....	<b>28</b>
	12.1 Valve Spare part list .....	28
	12.2 Position indicators 80°C (single + double) in various versions .....	29
<b>13</b>	<b>Appendix</b> .....	<b>30</b>

# 1 Description of product

## 1.1 Identification of product

The fabrication number and order number are fixed on the product directly or by means of an identification plate.

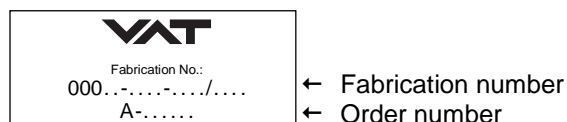

## 1.2 Use of product

Use product for clean and dry vacuum applications only. Other applications are only allowed with the written permission of VAT. Suitable for XHV applications.

## 1.3 Related documents

- Product data sheet
- Dimensional drawing

## 1.4 Important information



This symbol points to a very important statement that requires particular attention.

### Example:



VAT disclaims any liability for damages resulting from inappropriate packaging.

## 1.5 Technical data

See on product data sheet, to get »Technical data« details.

## 2 Safety

### 2.1 Compulsory reading material

Read this chapter prior to performing any work with or on the product. It contains important information that is significant for your own personal safety. This chapter must have been read and understood by all persons who perform any kind of work with or on the product during any stage of its serviceable life.

	NOTICE
	<p><b>Lack of knowledge</b>            Failing to read this manual may result in property damage.            Firstly, read manual.</p>



These Installation, Operating & Maintenance Instructions are an integral part of a comprehensive documentation belonging to a complete technical system. They must be stored together with the other documentation and accessible for anybody who is authorized to work with the system at any time.

### 2.2 Danger levels



	⚠ DANGER
	<p><b>High risk</b>            Indicates a hazardous situation which, if not avoided, will result in death or serious injury.</p>

	⚠ WARNING
	<p><b>Medium risk</b>            Indicates a hazardous situation which, if not avoided, could result in death or serious injury.</p>

	⚠ CAUTION
	<p><b>Low risk</b>            Indicates a hazardous situation which, if not avoided, may result in minor or moderate injury.</p>

	NOTICE
	<p><b>Command</b>            Indicates a hazardous situation which, if not avoided, may result in property damage.</p>

## 2.3 Personnel qualifications

	 <b>WARNING</b>
	<b>Unqualified personnel</b> Inappropriate handling may cause serious injury or property damage. Only qualified personnel are allowed to carry out the described work.

## 2.4 Safety labels

Label	Part No.	Location on valve
	T-9001-156	On protective covers of flanges

### 3 Design and Function

#### 3.1 Design

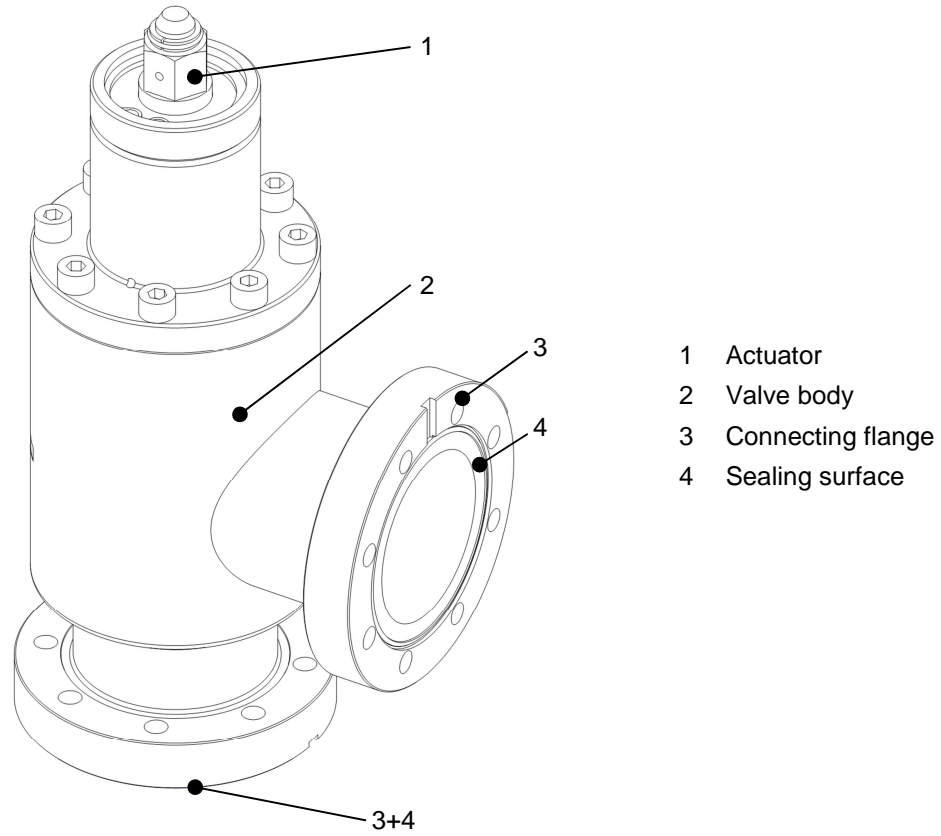



### 3.2 Function

Opening of closed valve

- Turn hexagon head counter clockwise to it's stop. The valve is completely open when the stop is reached.

Closing of open valve

- Valves with hexagon head may be operated by a torque wrench (nominal torque see table below) or by using a hand wheel with sliding clutch Valves with cylindrical head have to be operated by a hand wheel with sliding clutch and free wheel option (see spare parts list).

	Part / Ordering number		
	57036-. E02/05/07/08	57040-. E02/05/07/08	57044-. E02/05/07/08
Hexagon head wrench size	22mm	27mm	36mm
Cylindrical head diameter	20mm	30mm	-
Required torque for closing	45Nm	90Nm	125Nm
Maximum allowed closing-torque	51Nm	100Nm	154Nm

- Valves with hexagon head may be operated by ring or fork wrench or by using a hand wheel (see spare parts list).
- Valves with cylindrical head have to be operated by a hand wheel with free wheel option (see spare parts list).

## 4 Installation

	<b>WARNING</b>
	<p><b>Unqualified personnel</b>                  Inappropriate handling may cause serious injury or property damage.                  Only qualified personnel are allowed to carry out the described work.</p>

	<b>WARNING</b>
	<p><b>Heavy weight</b>                  Physical overstraining.                  Use a crane to lift the product.</p>

### 4.1 Unpacking

Handling of the valve must take place under clean conditions normally observed in good vacuum practice. The valve may only be touched with clean gloves. After the protective covers have been removed, the sealing surfaces of the flanges have to be cleaned carefully with alcohol. The screws of the flanges have to be tightened uniformly in diagonal crosswise order. Determine that the valve and existing plumbing in the vacuum system will be adequately supported.



- Make sure that the supplied products are in accordance with your order.
- Inspect the quality of the supplied products visually. If it does not meet your requirements, please contact VAT immediately.
- Store the original packaging material. It may be useful if products must be returned to VAT.





Keep valve in the plastic bag until it is being installed into the system.

	<b>NOTICE</b>
	<p><b>Sensitive product</b>                  Valve parts may get damaged.</p> <ul style="list-style-type: none"> <li>– When lifting the valve, pay attention that the valve does not touch any solid objects.</li> <li>– Lift valve carefully and put it down on a clean surface or mount it to a clean system.</li> </ul>

## 4.2 Installation into the system

The valve must not support other components and has to be protected from forces of the system (e.g. by bellows sections).

	<p style="text-align: center;"><b>⚠ WARNING</b></p> <p><b>Movable parts</b> Human body parts may get jammed and severely injured. Do not connect or supply electrical power before the product is completely mounted in the system.</p>
	<p style="text-align: center;"><b>NOTICE</b></p> <p><b>Contamination</b> Product may get contaminated. Always wear cleanroom gloves when handling the product.</p>
	<p style="text-align: center;"><b>NOTICE</b></p> <p><b>Force effect from other components of the system</b> Valve body may get deformed and/or malfunctions may occur.</p> <ul style="list-style-type: none"><li>– Do not use valve to support other components.</li><li>– Make sure that forces from other components do not impair the valve; use bellows sections, for instance.</li></ul>

#### 4.2.1 Preparation for installation

	<b>⚠ WARNING</b>
	<b>Danger of injury in case of insufficient skills</b> Inappropriate handling may cause serious injury or property damage. Make sure that the valve does not topple or fall down while removing the protective covers from the flanges.

	<b>NOTICE</b>
	<b>Sensitive product</b> Valve parts may get damaged. When removing the protective covers from the flanges, be careful to avoid damage to the valve.

1. Remove plastic bag.
2. Remove screws, Nuts and protective covers
3. Remove O-rings.



Store protective covers, O-rings, nuts and screws. They may be useful when valve needs to be repacked.

4. Clean sealing surfaces with cleanroom wiper soaked with pure alcohol (Isopropanol).
5. Clean sealing surface with clean, oil free compressed air.

## 4.2.2 Mounting to the system



The valve must not support other components and has to be protected from forces of the system (e.g. by bellows sections).

### 4.2.2.1 Leak detection port

The exact position of the leak detection port is referenced on the dimensional drawing



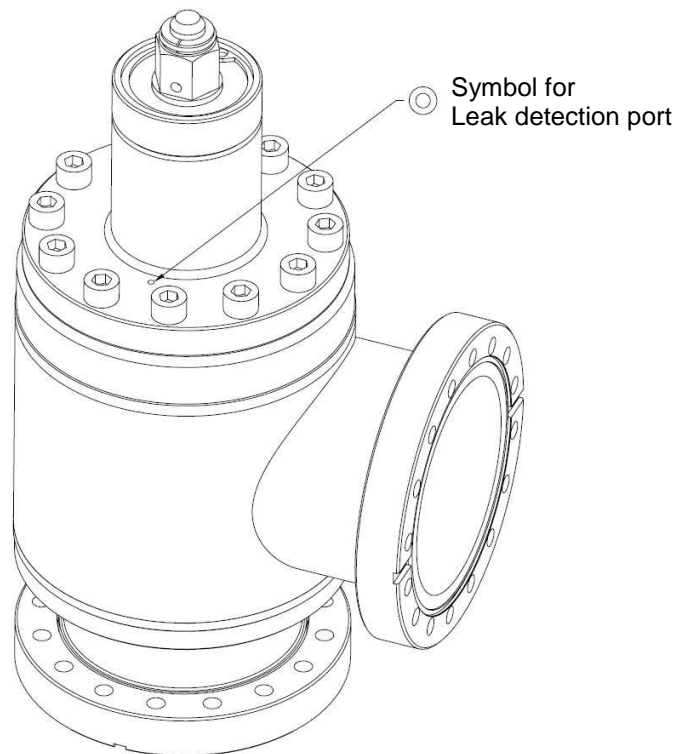

Do not block or cover the leak detection port, as shown on the sample picture



Sample picture

### 4.3 Electrical connection

	<p style="text-align: center;"><b>⚠ DANGER</b></p> <p><b>Electric shock</b> Parts being under voltage will result in serious injury or death. Do not touch parts being under voltage.</p>
	<p style="text-align: center;"><b>NOTICE</b></p> <p><b>Wrong sequence of connections</b> Valve mechanism may get damaged when electrical power is being is connected. Always install the valve into the vacuum system before connecting electrical power.</p>
	<p style="text-align: center;"><b>NOTICE</b></p> <p><b>Wrong voltage</b> Electrical components may get damaged. Supply electrical components with the correct voltage.</p>

**4.3.1 Position indicators**



Connect position indicator according to product data sheet.

**4.3.1.1 Wiring diagrams:**

**Position indicators for max. 80°C — contact rating ≤ 50 V AC / DC; ≤ 1.2 A**

<p>Standard position indicator with make contact switches</p> <p>Lo = position indicator «open» Lg = position indicator «closed»</p>	<p>Double position indicator with make contact switches - two each (option)</p> <p>Lo = position indicator «open» Lg = position indicator «closed»</p>
<p>Position indicator with double throw switches (option)</p> <p>Lo = position indicator «open» Lg = position indicator «closed»</p>	<p>Double position indicator with double throw switches - two each (option)</p> <p>Lo = position indicator «open» Lg = position indicator «closed»</p>

**Position indicators for max. 200°C and 300°C — contact rating ≤ 50 V AC / DC; ≤ 1 A**

<p>Single position indicator (option)</p> <p>Lo = position indicator «open» Lg = position indicator «closed»</p>	<p>Double position indicator (option)</p> <p>Lo = position indicator «open» Lg = position indicator «closed»</p>
--	--

## 5 Operation

	<b>⚠ WARNING</b>
	<p><b>Unqualified personnel</b>                  Inappropriate handling may cause serious injury or property damage.                  Only qualified personnel are allowed to carry out the described work.</p>

	<b>⚠ WARNING</b>
	<p><b>Movable parts</b>                  Human body parts may get jammed and severely injured.                  Do not operate before product is installed completely into the vacuum system.</p>

### 5.1 Normal operation

Opening of closed valve

- Turn hexagon head counter clockwise to it's stop. The valve is completely open when the stop is reached.

Closing of open valve

- Valves with hexagon head may be operated by a torque wrench (nominal torque see table below) or by using a hand wheel with sliding clutch Valves with cylindrical head have to be operated by a hand wheel with sliding clutch and free wheel option (see spare parts list).

	Part / Ordering number		
	57036-. E02/05/07/08	57040-. E02/05/07/08	57044-. E02/05/07/08
Hexagon head wrench size	22mm	27mm	36mm
Cylindrical head diameter	20mm	30mm	-
Required torque for closing	45Nm	90Nm	125Nm
Maximum allowed closing-torque	51Nm	100Nm	154Nm

- Valves with hexagon head may be operated by ring or fork wrench or by using a hand wheel (see spare parts list).
- Valves with cylindrical head have to be operated by a hand wheel with free wheel option (see spare parts list).



## 5.2 Operation under increased temperature

Maximum allowed temperature see product data sheet.

<b>NOTICE</b>	
	<p><b>Inconstant temperatures</b></p> <p>Performance of the valve may deteriorate.</p> <ul style="list-style-type: none"><li>– Actuate valve only after the bake-out temperature has been stable for two hours.</li><li>– If valve must be actuated during bake-out, make sure that the heating or cooling rate does not exceed 60 °C per hour in the temperature range from 200°C to 450 °C</li></ul>

## 5.3 Bake-out

See on product data sheet, to get »Bake out« details.

## 6 Trouble shooting

Failure	Check	Action	See
Leak at gate	Condition of gate seal	Please contact VAT	<a href="http://www.vatvalve.com">www.vatvalve.com</a>
Leak at body	Condition of bonnet seal and sealing surface	Please contact VAT	<a href="http://www.vatvalve.com">www.vatvalve.com</a>
	Condition of bellows	Please contact VAT	<a href="http://www.vatvalve.com">www.vatvalve.com</a>

If you need any further information, please contact one of our service centers. You will find the addresses on our website [www.vatvalve.com](http://www.vatvalve.com).

## 7 Maintenance

	<b>⚠ WARNING</b>
	<p><b>Unqualified personnel</b> Inappropriate handling may cause serious injury or property damage. Only qualified personnel are allowed to carry out the described work.</p>

	<b>NOTICE</b>
	<p><b>Inappropriate mounting position of valve</b> Maintenance may be troublesome and parts may drop down. Ideally dismount valve from the system and put it on a clean workbench with the actuator upwards.</p>

### 7.1 Maintenance intervals

Under clean operating conditions the valve does not require any maintenance during specified lifetime.



- Impacts from the process may require more frequent maintenance.
- When the valve has reached the specified lifetime; see product data sheet, we recommend to have it serviced by VAT. Please contact your nearest VAT service center to get recommendations and an offer. You will find the addresses on our website [www.vatvalve.com](http://www.vatvalve.com).

### 7.2 Preventive Maintenance

If there is a small leak please try to clean the sealing surface and the seal ring with a lint free towel and some alcohol.

If this doesn't help you can increase the sealing force by increasing the closing torque. The maximum torque is specified in the table under normal operation.



It's not allowed to exceed the maximum specified torque.

### 7.3 Re-greasing of actuator shaft:

- Remove the circlip (26/4) and washer (26/3)
- Remove the locking ring (26/5) and half shells of bearing (26/2)
- Remove the actuator shaft (26/1) from the spindle (62)
- Remove the Belleville springs (26/7) and washer (26/6)
- Clean actuator shaft (26/1, only thread) and internal thread of actuator, e.g. by using a smooth metal brush
- Re-grease these parts with a thin film of Fomblin RT15
- Reassemble actuator parts in reverse order

### 7.4 Replacement of dynamic seal VATRING



Don't touch inside valve parts without gloves



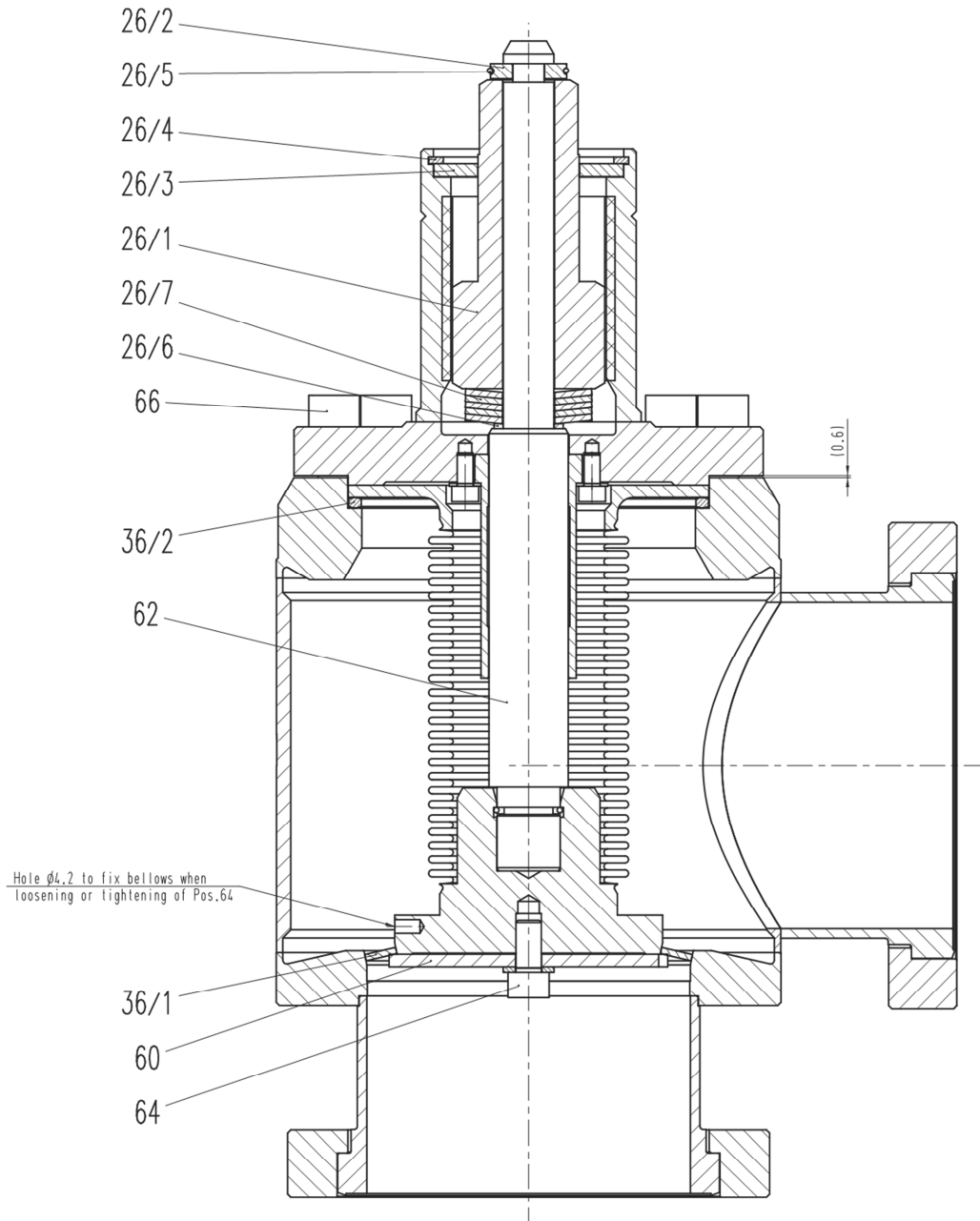

- Open the valve and loosen bonnet screws (66)
- Remove valve insert and bonnet seal (36/2)
- When loosening and tightening the screw (64) protect the bellows against torsion with hole  $\varnothing$  4.2
- Remove VATRING
- Take a lint free tissue dabbed with alcohol and clean all sealing surfaces (plate, bonnet, body - seat and bonnet, VATRING)
- Check sealing surfaces (visually) for scratches
- Clean VATRING and plate with cleaned and dry compressed air
- Place VATRING on sealing surface of the plate
- Place holding ring on top of plate
- Align VATRING parallel with the plate
- Insert screw (64), protect bellows against turning, tighten screw (torque according to below list)
- Place new bonnet seal (36/2)
- Put valve insert back into valve body and tighten screws in diagonal crosswise order (torque according to below list)

	Part / Ordering number		
	57036-. E02/05/07/08	57040-. E02/05/07/08	57044-. E02/05/07/08
closing torque of VATRING screw (Pos.64)	15 Nm	15 Nm	15 Nm
closing torque of bonnet screw (Pos.66)	15 Nm	35 Nm	35 Nm

**7.5 Drawing**







## 8 Repairs

	<p style="text-align: center;"><b>⚠ WARNING</b></p> <p><b>Unqualified personnel</b>                  Inappropriate handling may cause serious injury or property damage.                  Only qualified personnel are allowed to carry out the described work.</p>
	<p style="text-align: center;"><b>⚠ WARNING</b></p> <p><b>Danger of injury in case of insufficient skills</b>                  Inappropriate handling may cause serious injury or property damage.                  Make sure that the valve does not topple or fall down while removing the protective covers from the flanges.</p>
	<p style="text-align: center;"><b>⚠ WARNING</b></p> <p><b>Heavy weight</b>                  Physical overstraining.                  Use a crane to lift the product.</p>
	<p style="text-align: center;"><b>NOTICE</b></p> <p><b>Contamination</b>                  Product may get contaminated.                  Always wear cleanroom gloves when handling the product.</p>

Repairs may only be carried out by the VAT service staff. In exceptional cases, the customer is allowed to carry out the repairs, but only with the prior consent of VAT.

Please contact one of our service centers. You will find the addresses on our website [www.vatvalve.com](http://www.vatvalve.com).

## 9 Dismounting and Storage

	<p style="text-align: center;"><b>⚠ WARNING</b></p> <p><b>Unqualified personnel</b> Inappropriate handling may cause serious injury or property damage. Only qualified personnel are allowed to carry out the described work.</p>
	<p style="text-align: center;"><b>⚠ WARNING</b></p> <p><b>Hazardous components</b> Human body parts may get jammed and severely injured. Before dismantling the product: – disconnect electrical power supply</p>
	<p style="text-align: center;"><b>⚠ WARNING</b></p> <p><b>Movable parts</b> Human body parts may get jammed and severely injured. Keep human body parts away from movable parts.</p>
	<p style="text-align: center;"><b>⚠ WARNING</b></p> <p><b>Heavy weight</b> Physical overstraining. Use a crane to lift the product.</p>
	<p style="text-align: center;"><b>NOTICE</b></p> <p><b>Contamination</b> Product may get contaminated. Always wear cleanroom gloves when handling the product.</p>

### 9.1 Dismounting

1. Open the valve and secure the open position (by the transport protection).
2. Disconnect electrical power supply.
3. Dismount the valve according chapter «4 Installation», however in reverse order.



Observe safety instruction of chapter «4 Installation».

## 9.2 Storage





<b>NOTICE</b>	
	<p><b>Wrong storage</b></p> <p>Inappropriate temperatures and humidity may cause damage to the product.</p> <p>Valve must be stored at:</p> <ul style="list-style-type: none"><li>– relative humidity between 10% and 70%</li><li>– temperature between +10 °C and +50 °C</li><li>– non-condensing environment</li></ul>

<b>NOTICE</b>	
	<p><b>Inappropriate packaging</b></p> <p>Product may get damaged if inappropriate packaging material is used.</p> <p>Always use the original packaging material and handle product with care.</p>

1. Clean / decontaminate valve.
2. Mount protective covers on flanges; see chapter «4.2.1 Preparation for installation».
3. Pack valve appropriately, by using the original packaging material.



## 10 Packaging and Transport

	<p style="text-align: center;"><b>⚠ WARNING</b></p> <p><b>Unqualified personnel</b> Inappropriate handling may cause serious injury or property damage. Only qualified personnel are allowed to carry out the described work.</p>
	<p style="text-align: center;"><b>⚠ WARNING</b></p> <p><b>Harmful substances</b> Risk of injury in case of contact with harmful substances. Remove harmful substances (e. g. toxic, caustic or microbiological ones) from valve before you return the valve to VAT.</p>
	<p style="text-align: center;"><b>⚠ WARNING</b></p> <p><b>Heavy weight</b> Physical overstraining. Use a crane to lift the product.</p>
	<p style="text-align: center;"><b>NOTICE</b></p> <p><b>Inappropriate packaging</b> Product may get damaged if inappropriate packaging material is used. Always use the original packaging material and handle product with care.</p>



- When returning products to VAT, please fill out the VAT form «Declaration of Chemical Contamination» and send it to VAT in advance. The form can be downloaded from our website [www.vatvalve.com](http://www.vatvalve.com).
- If products are radioactively contaminated, the VAT form «Contamination and Radiation Report» must be filled out. Please contact VAT in advance.
- If products are sent to VAT in contaminated condition, VAT will carry out the decontamination procedure at the customer's expense.

## 10.1 Packaging

<b>NOTICE</b>	
	<p><b>Valve in closed or in undefined position</b> Valve mechanism may get damaged if valve is in close or undefined position. Make sure that the valve is in open position secured.</p>

1. Mount protective covers on flanges; see chapter «4.2.1 Preparation for installation».
2. Pack valve appropriately, by using the original packaging material.



VAT disclaims any liability for damages resulting from inappropriate packaging.

## 10.2 Transport

<b>NOTICE</b>	
	<p><b>Inappropriate packaging</b> Product may get damaged if inappropriate packaging material is used. Always use the original packaging material and handle product with care.</p>





VAT disclaims any liability for damages resulting from inappropriate packaging.

## 11 Disposal

Observe the local regulations for disposal

	<b>⚠ WARNING</b>
	<p><b>Harmful substances</b> Environmental pollution. Discard products and parts according to the local regulations.</p>

	<b>⚠ WARNING</b>
	<p><b>Unqualified personnel</b> Inappropriate handling may cause serious injury or property damage. Only qualified personnel are allowed to carry out the disposal.</p>

	<b>⚠ CAUTION</b>
	<p><b>Risk of damage</b> Indicates a hazardous situation which, if not avoided, may result in minor or moderate injury. A large number of diverse materials are used in the product. Some of them could cause human and machine damage in the case of improper handling.</p> <ul style="list-style-type: none"> <li>• Observe local regulations in regard to waste disposal without fail.</li> <li>• Commission an authorized waste disposal company for the professional disposal of your waste.</li> </ul>

	<b>NOTICE</b>
	<p><b>Improper disposal</b> Some built-in materials can cause damage, if improperly handled. - When disposing, take into account all the different materials used</p>



- Hire an authorised waste disposal company to dispose of the waste in a professional manner.

The following list should help you to dismantle your product without making serious errors and to properly separate out the product scrap.

Material groups	Hazard level
non-ferrous metals	high
stainless steel	low
aluminium	low
plastics	medium
lubricants	high
electronic scrap	high
batteries	very high
cables and wires	medium
motors	medium
seals and rubber parts	high

## 12 Spare parts

	NOTICE
	<p><b>Non-original spare parts</b></p> <p>Non-original spare parts may cause damage to the product. Use original spare parts from VAT only.</p>



- Please specify the fabrication number of the product when you place an order for spare parts; see chapter «1.1 Identification of product». This is to ensure that the appropriate spare parts are supplied.
- VAT makes a difference between spare parts that may be replaced by the customer and those that need to be replaced by the VAT service staff.
- The Item list only contains spare parts that may be replaced by the customer. If you need any other spare parts, please contact one of our service centers. You will find the addresses on our website [www.vatvalve.com](http://www.vatvalve.com).

### 12.1 Valve Spare part list

Item	Description	Qty per Valve	Part / Ordering number		
			57036-....	57040-....	57044-....
36/1	VATRING	1	39615-01	39986-01	35774-01
36/2	Bonnet seal	1	51914-03	51914-08	213816
60	Holding ring	1	96868-01	99914-01	213794
64	Screw with venting hole	1	214314		
66	Treated hexagon socket head cap screw	6	N-5019-816	-	-
		12	-	N-5019-839	-
		16	-	-	N-5019-839
99	Hand wheel for hexagon head	1	73753-R1	82438-R1	-
99	Hand wheel for cylindrical head	1	75287-R1	73741-R1	-
	Vacuum seal kit, consisting of VATRING and bonnet seal	1	83173-R1	83921-R1	215875

## 12.2 Position indicators 80°C (single + double) in various versions

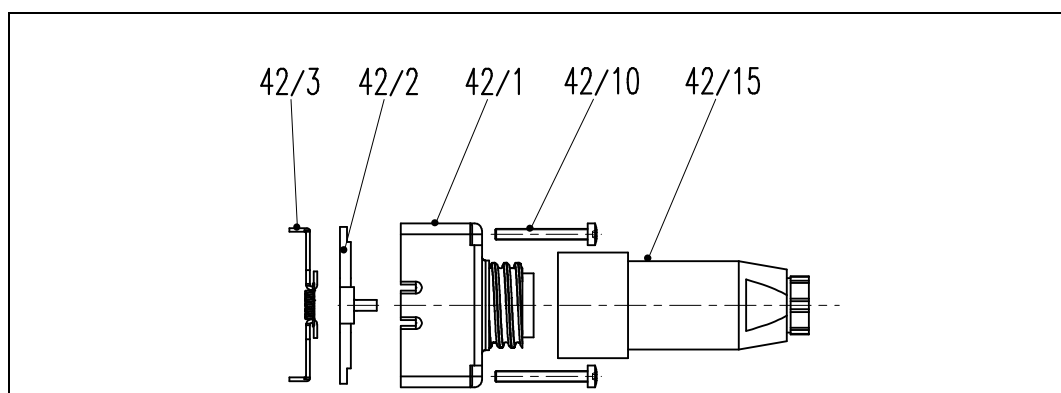

Item	Description	Version	Qty.		Part No.
			single	double	
42	BS Mini position indicator	make contact switches	1	2	69250-R1
		double throw switches	1	2	75430-R1
		make contact radiation resistant	1	2	90471-R1
		double throw radiation resistant	1	2	91701-R1
42/1	Position indicator	make contact switches	1	2	71852-R1
		double throw switches	1	2	70606-R1
		make contact radiation resistant	1	2	80075-R1
		double throw radiation resistant	1	2	83954-R1
42/2	Slider		1	2	69846-01
42/3	Driving piece		1	2	69428-R1
42/10	Screw		4	8	N-6016-078
42/15	Socket		1	2	N-8504-002

## 13 Appendix

---

This Page Intentionally Left Blank