

Installation, Operating & Maintenance Instructions



All-metal angle valve Double acting pneumatic actuator

Series 570
DN 100 mm – 160 mm (I. D. 4" – 6")

This manual is valid for the following product ordering numbers:

57040-.E14/E24/E34/E44
57044-.E14/E24/E34/E44

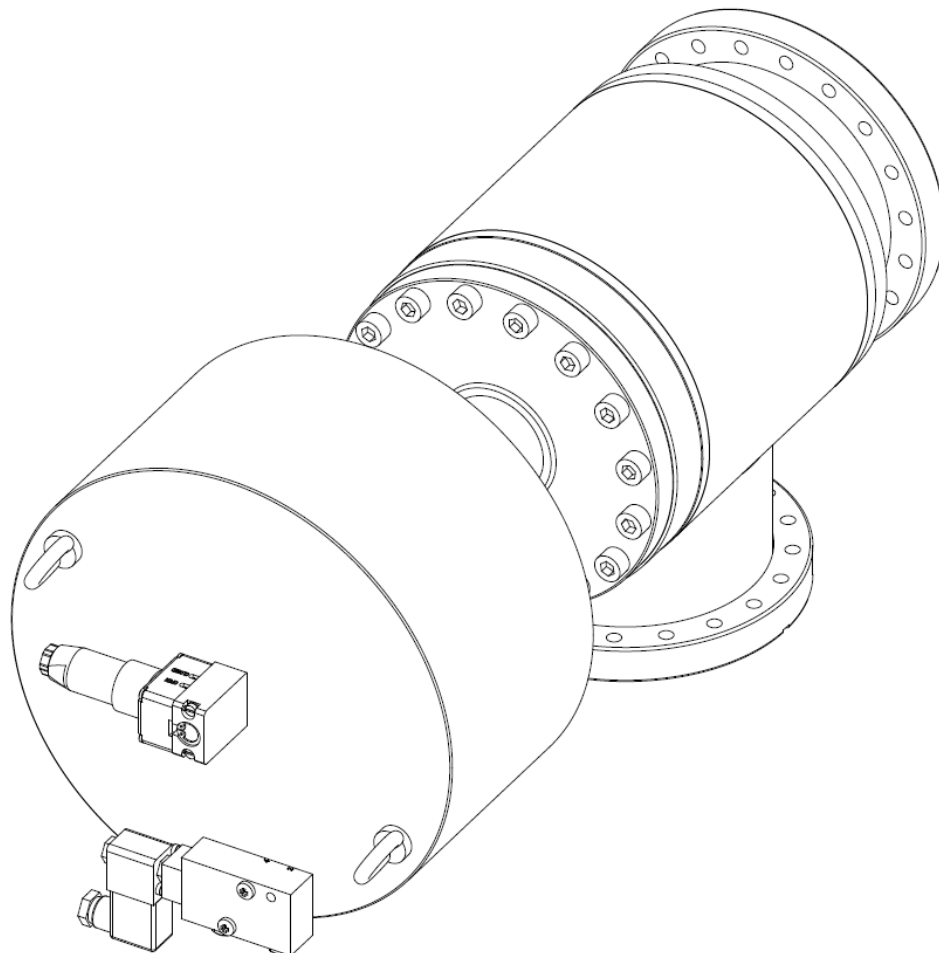

Sample picture

Imprint

Manufacturer VAT Vakuumventile AG, CH-9469 Haag, Switzerland

Website: www.vatvalve.com
Phone: +41 81 771 61 61
Fax: +41 81 771 48 30
Email: CH@vatvalve.com

Publisher VAT Vakuumventile AG, CH-9469 Haag, Switzerland

Editor VAT Vakuumventile AG, CH-9469 Haag, Switzerland

Print VAT Vakuumventile AG, CH-9469 Haag, Switzerland

Copyright © VAT Vakuumventile AG 2019

No part of these Instructions may be reproduced in any way (photocopies, microfilms or any other reproduction processes) nor may it be manipulated with electronic systems, duplicated or distributed without written permission from VAT. Offenders are liable to pay damages.

The original VAT firmware and updated state of the art versions of the VAT firmware are intended for use with VAT products. The VAT firmware contains a limited, time unlimited user license. The VAT firmware may not be used for purposes other than those intended nor is it permitted to make copies of the VAT firmware. In particular, it is strictly forbidden to give copies of the VAT firmware to other people.

The use of trade names, brand names, trademarks, etc. in these Instructions does not entitle third parties to consider these names to be unprotected and to use them freely. This is in accordance with the meaning of the laws and acts covering brand names and trademarks.

Contents

1	Description of product.....	5
1.1	Identification of product.....	5
1.2	Use of product.....	5
1.3	Related documents	5
1.4	Important information	5
1.5	Technical data.....	5
2	Safety	6
2.1	Compulsory reading material	6
2.2	Danger levels	6
2.3	Personnel qualifications	7
2.4	Safety labels.....	7
3	Design and Function.....	8
3.1	Design	8
3.2	Function	9
4	Installation	10
4.1	Unpacking	10
4.2	Installation into the system.....	12
4.2.1	Preparation for installation	13
4.2.2	Mounting to the system	14
4.2.2.1	Leak detection port	14
4.3	Compressed air connection	15
4.4	Electrical connection	17
4.4.1	Solenoid.....	17
4.4.2	Position indicators.....	18
5	Operation	20
5.1	Normal operation.....	20
5.2	Operation under increased temperature	21
5.3	Bake-out.....	21
5.4	Behavior in case of compressed air pressure drop	22
5.5	Behavior in case of power failure.....	22
6	Trouble shooting.....	23
7	Maintenance	24
7.1	Maintenance intervals	24
7.2	Preventive Maintenance	25
7.2.1	Instruction how to change the VATRING	25
7.3	Drawing.....	26
8	Repairs	27
9	Dismounting and Storage.....	28
9.1	Dismounting	28
9.2	Storage.....	29
10	Packaging and Transport	30
10.1	Packaging	31

10.2	Transport	31
11	Disposal.....	32
12	Spare parts.....	33
12.1	Valve Spare part list	33
12.2	Air connection kit (solenoid on customer's site)	34
12.3	Solenoid kit (5/2-way standard).....	35
12.4	Solenoid kit (5/2-way impulse actuation).....	36
12.5	Position indicators 80°C (single + double) in various versions with adapter	37
12.6	Position indicators 200°C (single + double) with adapter	38
13	Appendix	39

1 Description of product

1.1 Identification of product

The fabrication number and order number are fixed on the product directly or by means of an identification plate.

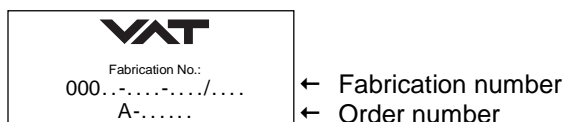

1.2 Use of product

Use product for clean and dry indoor vacuum applications under the conditions indicated in chapter «Technical data» only! Other applications are only allowed with the written permission of VAT.

1.3 Related documents

- Product data sheet
- Dimensional drawing

1.4 Important information



This symbol points to a very important statement that requires particular attention.

Example:



VAT disclaims any liability for damages resulting from inappropriate packaging.

1.5 Technical data

See on product data sheet, to get »Technical data« details.

2 Safety

2.1 Compulsory reading material

Read this chapter prior to performing any work with or on the product. It contains important information that is significant for your own personal safety. This chapter must have been read and understood by all persons who perform any kind of work with or on the product during any stage of its serviceable life.

	NOTICE
	<p>Lack of knowledge Failing to read this manual may result in property damage. Firstly, read manual.</p>



These Installation, Operating & Maintenance Instructions are an integral part of a comprehensive documentation belonging to a complete technical system. They must be stored together with the other documentation and accessible for anybody who is authorized to work with the system at any time.

2.2 Danger levels

	⚠ DANGER
	<p>High risk Indicates a hazardous situation which, if not avoided, will result in death or serious injury.</p>

	⚠ WARNING
	<p>Medium risk Indicates a hazardous situation which, if not avoided, could result in death or serious injury.</p>

	⚠ CAUTION
	<p>Low risk Indicates a hazardous situation which, if not avoided, may result in minor or moderate injury.</p>

	NOTICE
	<p>Command Indicates a hazardous situation which, if not avoided, may result in property damage.</p>

2.3 Personnel qualifications

	⚠ WARNING	
	Unqualified personnel Inappropriate handling may cause serious injury or property damage. Only qualified personnel are allowed to carry out the described work.	

2.4 Safety labels

Label	Part No.	Location on valve
	T-9001-156	On protective covers of flanges

3 Design and Function

3.1 Design

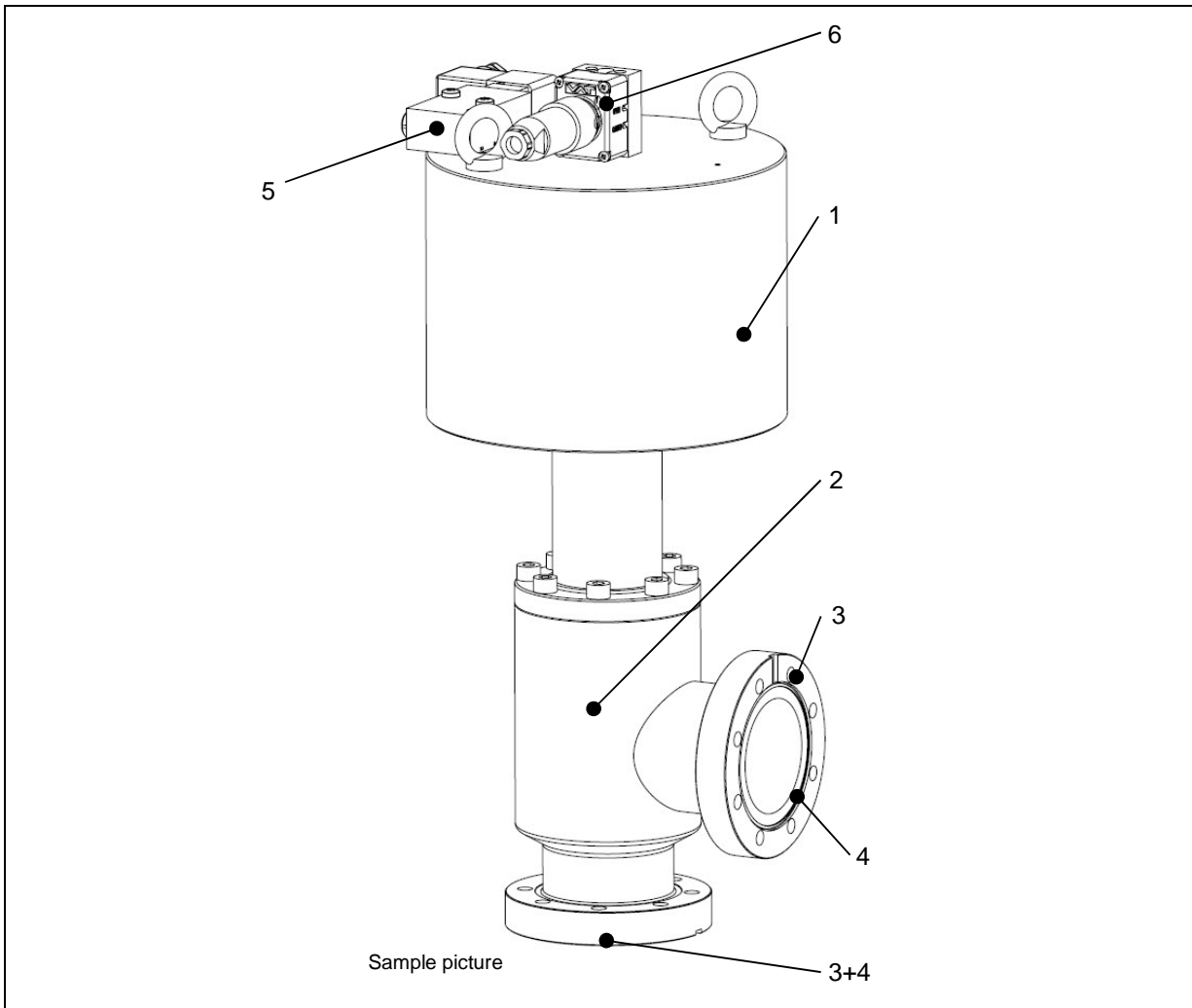

- 1 Actuator
- 2 Valve body
- 3 Connecting flange
- 4 Sealing surface
- 5 Solenoid
- 6 Position indicator

3.2 Function

Opening of closed valve

- without solenoid:
 - air supply to connection «open»
 - air release through connection «closed»
- with standard solenoid:
 - supply specified control voltage to the coil
- with impulse solenoid:
 - supply an impulse of specified control voltage to the coil for opening (pulse duration min. 50 ms)

Closing of open valve

- without solenoid:
 - air supply to connection «close»
 - air release through connection «open»
- with standard solenoid:
 - release control voltage
- with impulse solenoid:
 - supply an impulse of specified control voltage to the coil for opening (pulse duration min. 50 ms)



Ascertain that the circlip connecting the lid to the cylinder is correctly in place. Even with disconnected supply, loaded springs and/or air cushions in cylinders can be potential hazards.

4 Installation

	⚠ WARNING
	Unqualified personnel Inappropriate handling may cause serious injury or property damage. Only qualified personnel are allowed to carry out the described work.

	⚠ WARNING
	Heavy weight Physical overstraining. Use a crane to lift the product.

4.1 Unpacking

Handling of the valve must take place under clean conditions normally observed in good vacuum practice. The valve may only be touched with clean gloves. After the protective covers have been removed, the sealing surfaces of the flanges have to be cleaned carefully with alcohol. The screws of the flanges have to be tightened uniformly in diagonal crosswise order. Determine that the valve and existing plumbing in the vacuum system will be adequately supported.



- Make sure that the supplied products are in accordance with your order.
- Inspect the quality of the supplied products visually. If it does not meet your requirements, please contact VAT immediately.
- Store the original packaging material. It may be useful if products must be returned to VAT.



Open the plastic bag protecting the valve only at the points where you need access to the eyebolts (1) for fastening the crane hooks; see below. Keep valve in the plastic bag until it is being installed into the system.

NOTICE



Wrong lifting

Valve may crash and get damaged.

Use only the eyebolts shown in the dimensional drawing and in on sample picture to lift the valve. Using any other components (e. g. position indicators, solenoids) to lift the valve is strictly forbidden.

NOTICE



Sensitive product

Valve parts may get damaged.

- When lifting the valve, pay attention that the valve does not touch any solid objects.
- Lift valve carefully and put it down on a clean surface or mount it to a clean system.



Use a crane for lifting valve out of the transport box



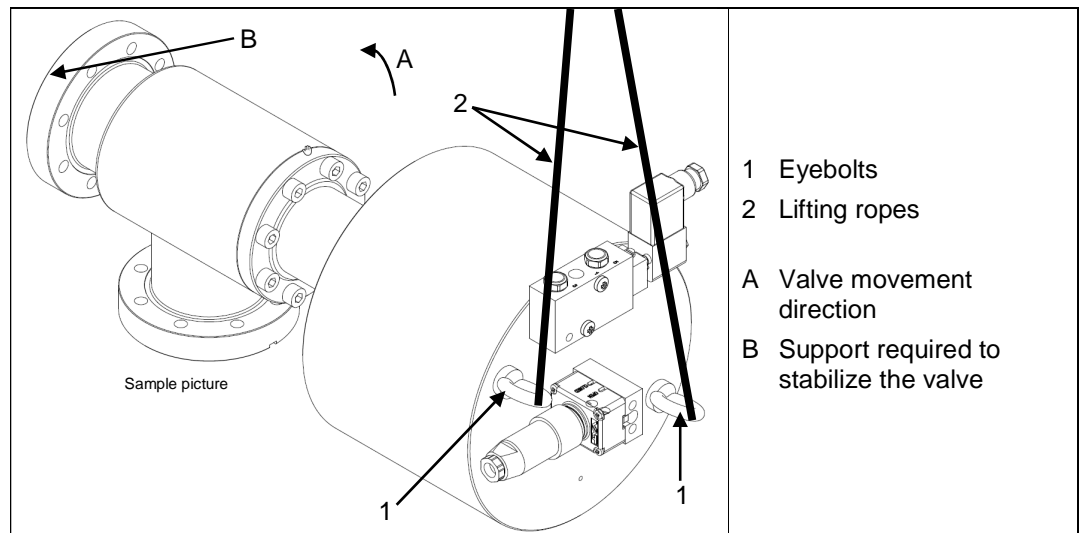

To see the Weight of valve, take a look into the product data sheet.





4.2 Installation into the system

The valve must not support other components and has to be protected from forces of the system (e.g. by bellows sections).

	<p style="text-align: center;">⚠ WARNING</p> <p>Movable parts Human body parts may get jammed and severely injured. Do not connect or supply electrical power and compressed air before the product is completely mounted in the system.</p>
	<p style="text-align: center;">NOTICE</p> <p>Contamination Product may get contaminated. Always wear cleanroom gloves when handling the product.</p>
	<p style="text-align: center;">NOTICE</p> <p>Force effect from other components of the system Valve body may get deformed and/or malfunctions may occur.</p> <ul style="list-style-type: none"> – Do not use valve to support other components. – Make sure that forces from other components do not impair the valve; use bellows sections, for instance.

4.2.1 Preparation for installation

	⚠ WARNING
	<p>Danger of injury in case of insufficient skills Inappropriate handling may cause serious injury or property damage. Make sure that the valve does not topple or fall down while removing the protective covers from the flanges.</p>

	NOTICE
	<p>Sensitive product Valve parts may get damaged. When removing the protective covers from the flanges, be careful to avoid damage to the valve.</p>

1. Remove plastic bag.
2. Remove screws, Nuts and protective covers
3. Remove O-rings.



Store protective covers, O-rings, nuts and screws. They may be useful when valve needs to be repacked.

4. Clean sealing surfaces with cleanroom wiper soaked with pure alcohol (Isopropanol).
5. Clean sealing surface with clean, oil free compressed air.

4.2.2 Mounting to the system



The valve must not support other components and has to be protected from forces of the system (e.g. by bellows sections).

4.2.2.1 Leak detection port

The exact position of the leak detection port is referenced on the dimensional drawing



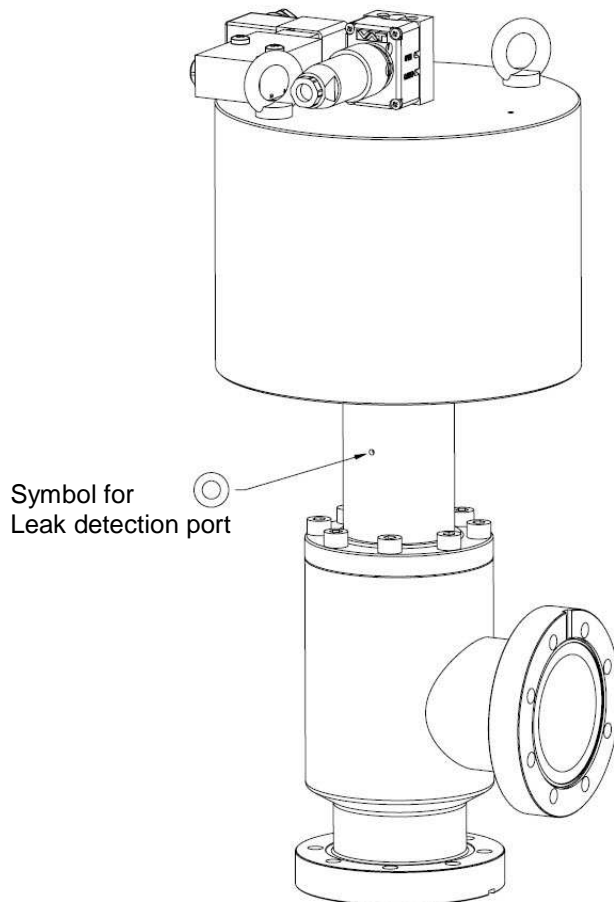

Do not block or cover the leak detection port, as shown on the sample picture



Sample picture

4.3 Compressed air connection

	⚠ WARNING
	<p>Valve in open or closed position</p> <p>Risk of injury when compressed air is connected to the valve.</p> <p>Connect compressed air only when:</p> <ul style="list-style-type: none"> - valve is installed in the vacuum system - moving parts cannot be touched

	NOTICE
	<p>Wrong sequence of connections</p> <p>Valve mechanism may get damaged when electrical power is being connected before compressed air is connected.</p> <p>Always connect compressed air before connecting electrical power.</p>



Check if the circlip connecting the lid to the cylinder is in the proper position.



Use clean, dry or slightly oiled air only.



Admissible air pressure range, see product data sheet.



Check if the circlip connecting the lid to the cylinder is in the proper position.



Supply compressed air pressure only after the supply line is properly mounted to the actuator.

- Connection: internal thread R 1/8" (1/8" NPT for USA)
- Connection for compressed air supply: ☉
- Compressed air pressure (min. – max.): 4 - 5 bar / 55 - 70 psi

Without solenoid

Connections «open» and «closed» for air supply

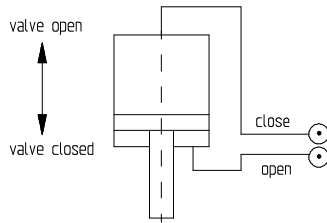

With solenoid

Connection «1» for air supply, connections «3» and «5» for exhaust

Standard solenoid

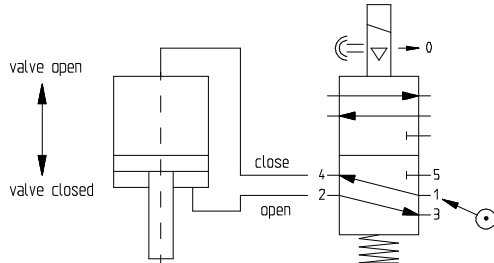

Solenoid for impulse actuation

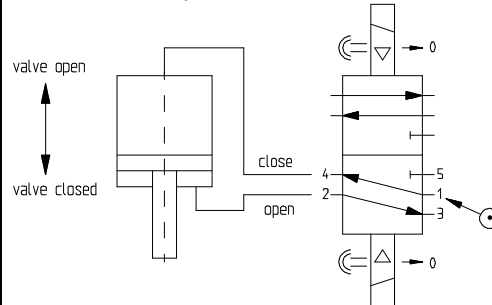

4.4 Electrical connection

	⚠ DANGER
	<p>Electric shock</p> <p>Parts being under voltage will result in serious injury or death. Do not touch parts being under voltage.</p>

	NOTICE
	<p>Wrong sequence of connections</p> <p>Valve mechanism may get damaged when electrical power is being connected. Always install the valve into the vacuum system before connecting electrical power.</p>

	NOTICE
	<p>Wrong voltage</p> <p>Electrical components may get damaged. Supply electrical components with the correct voltage.</p>

4.4.1 Solenoid

Wiring diagrams:

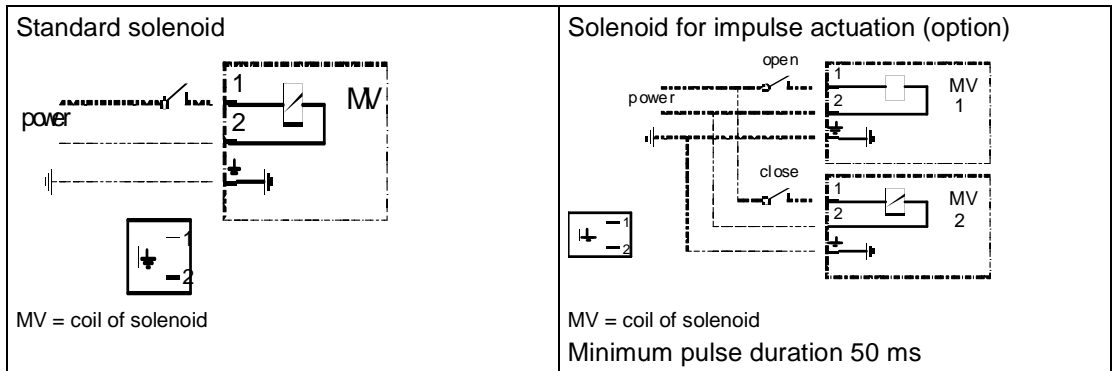

4.4.2 Position indicators

Wiring diagrams:

Position indicators for max. 80°C — contact rating ≤ 50 V AC / DC; ≤ 1.2 A

<p>Standard position indicator with make contact switches</p> <p>Lo = position indicator «open» Lg = position indicator «closed»</p>	<p>Double position indicator with make contact switches - two each (option)</p> <p>Lo = position indicator «open» Lg = position indicator «closed»</p>
<p>Position indicator with double throw switches (option)</p> <p>Lo = position indicator «open» Lg = position indicator «closed»</p>	<p>Double position indicator with double throw switches - two each (option)</p> <p>Lo = position indicator «open» Lg = position indicator «closed»</p>

Position indicator for max. 80°C — contact rating ≤ 50 V AC / DC; ≤ 1.2 A

<p>Position indicator radiation resistant 10E6Gy with make contact switches</p> <p>Lo = position indicator «open» Lg = position indicator «closed»</p>
--

Position indicators for max. 200°C and 300°C — contact rating ≤ 50 V AC / DC; ≤ 1 A

Single position indicator (option)

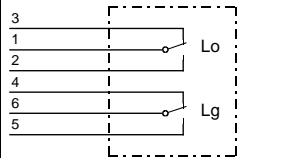

Lo = position indicator «open»
Lg = position indicator «closed»

Double position indicator (option)

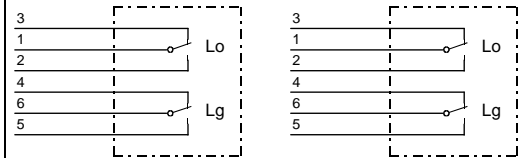

Lo = position indicator «open»
Lg = position indicator «closed»

Position indicator for max. 80°C — contact rating ≤ 50 V AC / DC; ≤ 1.2 A

Common plug for pos. indicator and solenoid, pos. indicator with make contact switches (option)

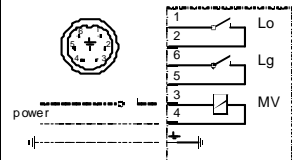

Lo = position indicator «open»
Lg = position indicator «closed»

5 Operation

	⚠ WARNING
	Unqualified personnel Inappropriate handling may cause serious injury or property damage. Only qualified personnel are allowed to carry out the described work.

	⚠ WARNING
	Movable parts Human body parts may get jammed and severely injured. Do not operate before product is installed completely into the vacuum system.

5.1 Normal operation

Opening of closed valve

- without solenoid:
 - air supply to connection «open»
 - air release through connection «closed»
- with standard solenoid:
 - supply specified control voltage to the coil
- with impulse solenoid:
 - supply an impulse of specified control voltage to the coil for opening (pulse duration min. 50 ms)

Closing of open valve

- without solenoid:
 - air supply to connection «close»
 - air release through connection «open»
- with standard solenoid:
 - release control voltage
- with impulse solenoid:
 - supply an impulse of specified control voltage to the coil for opening (pulse duration min. 50 ms)



Ascertain that the circlip connecting the lid to the cylinder is correctly in place. Even with disconnected supply, loaded springs and/or air cushions in cylinders can be potential hazards.

5.2 Operation under increased temperature

Maximum allowed temperature see product data sheet.

NOTICE	
	<p>Inconstant temperatures</p> <p>Performance of the valve may deteriorate.</p> <ul style="list-style-type: none">– Actuate valve only after the bake-out temperature has been stable for two hours.– If valve must be actuated during bake-out, make sure that the heating or cooling rate does not exceed 30 °C per hour in the temperature range from 200°C to 450 °C

5.3 Bake-out

See on product data sheet, to get »Bake out« details.

5.4 Behavior in case of compressed air pressure drop

Valve closed: valve position is undefined
 Valve open: valve position is undefined

5.5 Behavior in case of power failure

Standard solenoid: Valve closes

Solenoid for impulse actuation (option): Valve position does not change, a started movement will be completed.

Emergency operation at power failure

Option: Solenoids with an emergency operation (slotted screw) to operate the valve in case of a power failure (with compressed air available)

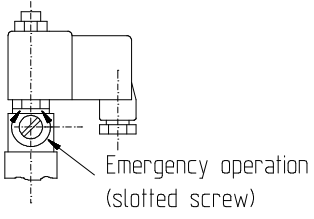
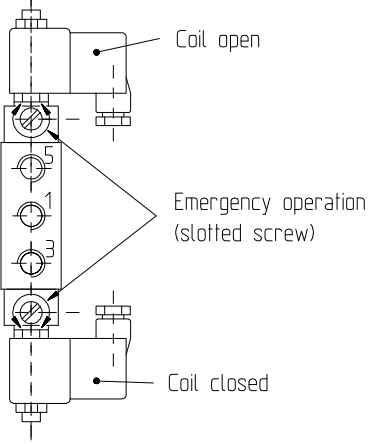
<p>Standard solenoid</p> <p>To <u>close</u> the valve: Turn the slotted screw counter-clockwise to its stop</p> <p>To <u>open</u> the valve: Turn the slotted screw clockwise to its stop</p> <p>For remote operation make sure that the slotted screw is turned counter-clockwise to its stop.</p>	
<p>Solenoid for impulse actuation</p> <p>To <u>close</u> the valve: Turn the slotted screw (coil «closed») clockwise to its stop. If the valve is closed, turn the screw back to its original position.</p> <p>To <u>open</u> the valve: Turn the slotted screw (coil «open») clockwise to its stop. If the valve is open, turn the screw back to its original position.</p> <p>For remote operation make sure that both slotted screws are turned counter-clockwise to their stop (original position).</p>	

6 Trouble shooting

Failure	Check	Action	See
Valve mechanism does not move	Compressed air	Connect compressed air	«4.3 Compressed air connection»
	Electrical power	Connect electrical power	«4.4 Electrical connection»
	Operating pressure	Adjust operating pressure	«4.3 Compressed air connection»
	Slotted screw of solenoid in proper position?	Check slotted screw!	«5.5 Behavior in case of power failure»
Leak at gate	Condition of gate seal	Please contact VAT	www.vatvalve.com
	Operating pressure	Adjust operating pressure	«4.3 Compressed air connection»
Leak at body	Condition of bonnet seal and sealing surface	Please contact VAT	www.vatvalve.com
	Condition of bellows	Please contact VAT	www.vatvalve.com

If you need any further information, please contact one of our service centers. You will find the addresses on our website www.vatvalve.com.

7 Maintenance

	⚠ WARNING
	Unqualified personnel Inappropriate handling may cause serious injury or property damage. Only qualified personnel are allowed to carry out the described work.

	NOTICE
	Inappropriate mounting position of valve Maintenance may be troublesome and parts may drop down. Ideally dismount valve from the system and put it on a clean workbench with the actuator upwards.



- Products returned to VAT must be free of harmful substances such as e.g. toxic, caustic or microbiological ones. If products are radioactively contaminated, fill in the VAT form «Contamination and Radiation Report» and send it with the product. The form is available at VAT. The maximum values indicated in the form must not be exceeded.

7.1 Maintenance intervals

Under clean operating conditions the valve does not require any maintenance during specified lifetime.



- Impacts from the process may require more frequent maintenance.
- When the valve has reached the specified lifetime; see product data sheet, we recommend to have it serviced by VAT. Please contact your nearest VAT service center to get recommendations and an offer. You will find the addresses on our website www.vatvalve.com.

7.2 Preventive Maintenance

If there is a small leak please try to clean the sealing surface and the seal ring with a lint free towel and some alcohol.

If this doesn't help you can increase the sealing force by increasing the closing torque. The maximum torque is specified in the table under normal operation.



It's not allowed to exceed the maximum specified torque.

7.2.1 Instruction how to change the VATRING



Don't touch inside valve parts without gloves.

Item numbers refer to the drawing on page 26.

- Open the valve and remove the bonnet screws (Pos.69).
- Remove valve insert and bonnet seal (Pos.36/2).
- When opening or tightening screw (Pos.67) the bellows must be protected against turning (torsion) → shown on the next page.
- Remove VATRING.
- Take a lint free tissue dabbed with alcohol and clean all sealing surfaces (plate, bonnet, body seat and VATRING).
- Check sealing surfaces (visually) for scratches.
- Clean VATRING and plate with clean and dry compressed air.
- Place VATRING on sealing surface of the plate.
- Align VATRING parallel with the frontal of the plate.
- Place holding ring on top of plate.
- Insert screw (Pos.67), protect bellow against turning, tighten screw (torque see list).
- Place new bonnet seal (fig.36/2) exactly like shown on next page (fitting position)!
- Put valve insert back into valve body and tighten bonnet screws in crosswise order (see torque list).

Description	Torque DN 100	Torque DN 160
closing torque of screw with venting hole (pos. 64)	15 Nm	15 Nm
closing torque of bonnet screw (pos. 66)	35 Nm	35 Nm

7.3 Drawing

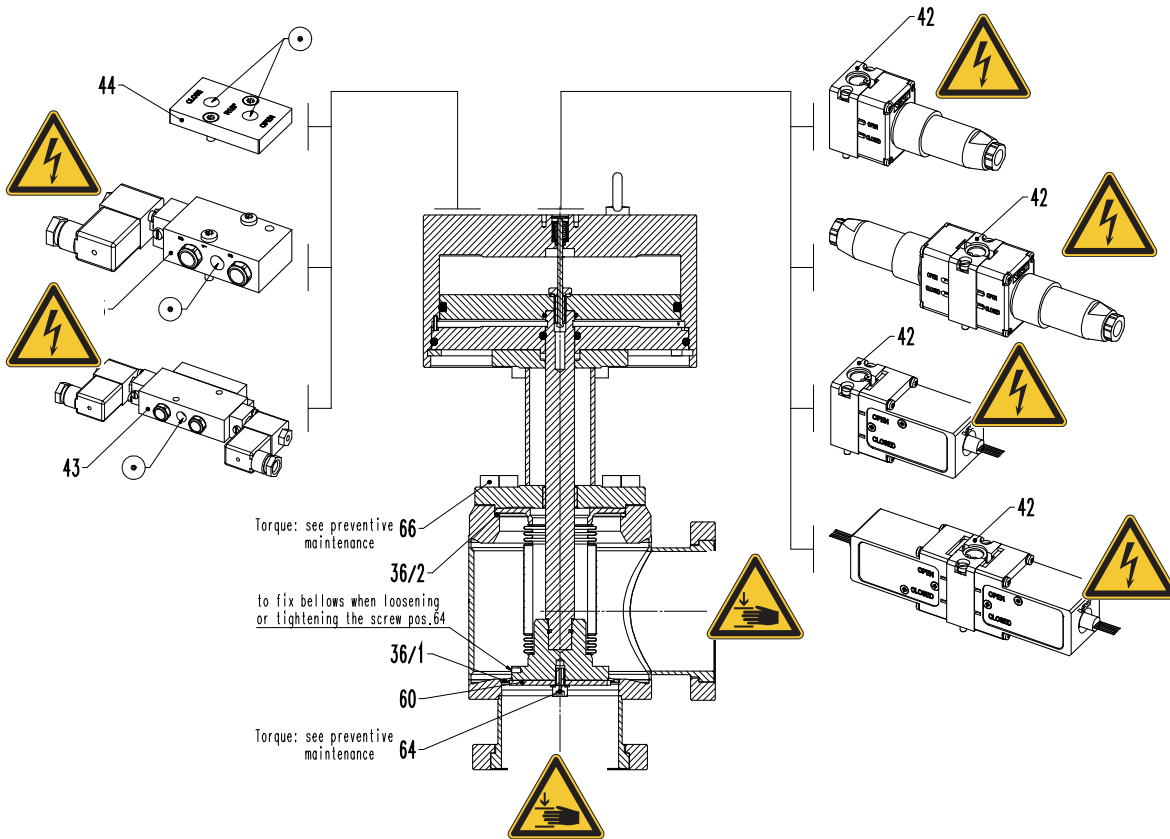





8 Repairs

	<p style="text-align: center;">⚠ WARNING</p> <p>Unqualified personnel Inappropriate handling may cause serious injury or property damage. Only qualified personnel are allowed to carry out the described work.</p>
	<p style="text-align: center;">⚠ WARNING</p> <p>Danger of injury in case of insufficient skills Inappropriate handling may cause serious injury or property damage. Make sure that the valve does not topple or fall down while removing the protective covers from the flanges.</p>
	<p style="text-align: center;">⚠ WARNING</p> <p>Heavy weight Physical overstraining. Use a crane to lift the product.</p>
	<p style="text-align: center;">NOTICE</p> <p>Contamination Product may get contaminated. Always wear cleanroom gloves when handling the product.</p>

Repairs may only be carried out by the VAT service staff. In exceptional cases, the customer is allowed to carry out the repairs, but only with the prior consent of VAT.

Please contact one of our service centers. You will find the addresses on our website www.vatvalve.com.

9 Dismounting and Storage

	<p style="text-align: center;">⚠ WARNING</p> <p>Unqualified personnel Inappropriate handling may cause serious injury or property damage. Only qualified personnel are allowed to carry out the described work.</p>
	<p style="text-align: center;">⚠ WARNING</p> <p>Hazardous components Human body parts may get jammed and severely injured. Before dismounting the product: – disconnect compressed air supply – disconnect electrical power supply</p>
	<p style="text-align: center;">⚠ WARNING</p> <p>Movable parts Human body parts may get jammed and severely injured. Keep human body parts away from movable parts.</p>
	<p style="text-align: center;">⚠ WARNING</p> <p>Heavy weight Physical overstraining. Use a crane to lift the product.</p>
	<p style="text-align: center;">NOTICE</p> <p>Contamination Product may get contaminated. Always wear cleanroom gloves when handling the product.</p>

9.1 Dismounting

1. Disconnect electrical power supply.
2. Disconnect compressed air supply.
3. Dismount the valve according chapter «4 Installation», however in reverse order.



Observe safety instruction of chapter «4 Installation».





9.2 Storage

NOTICE	
	<p>Wrong storage</p> <p>Inappropriate temperatures and humidity may cause damage to the product.</p> <p>Valve must be stored at:</p> <ul style="list-style-type: none">– relative humidity between 10% and 70%– temperature between +10 °C and +50 °C– non-condensing environment

NOTICE	
	<p>Inappropriate packaging</p> <p>Product may get damaged if inappropriate packaging material is used.</p> <p>Always use the original packaging material and handle product with care.</p>

1. Clean / decontaminate valve.
2. Mount protective covers on flanges; see chapter «4.2.1 Preparation for installation».
3. Pack valve appropriately, by using the original packaging material.

10 Packaging and Transport

	<p style="text-align: center;">⚠ WARNING</p> <p>Unqualified personnel Inappropriate handling may cause serious injury or property damage. Only qualified personnel are allowed to carry out the described work.</p>
	<p style="text-align: center;">⚠ WARNING</p> <p>Harmful substances Risk of injury in case of contact with harmful substances. Remove harmful substances (e. g. toxic, caustic or microbiological ones) from valve before you return the valve to VAT.</p>
	<p style="text-align: center;">⚠ WARNING</p> <p>Heavy weight Physical overstraining. Use a crane to lift the product.</p>
	<p style="text-align: center;">NOTICE</p> <p>Inappropriate packaging Product may get damaged if inappropriate packaging material is used. Always use the original packaging material and handle product with care.</p>



- When returning products to VAT, please fill out the VAT form «Declaration of Chemical Contamination» and send it to VAT in advance. The form can be downloaded from our website www.vatvalve.com.
- If products are radioactively contaminated, the VAT form «Contamination and Radiation Report» must be filled out. Please contact VAT in advance.
- If products are sent to VAT in contaminated condition, VAT will carry out the decontamination procedure at the customer's expense.

10.1 Packaging

	NOTICE
	<p>Valve in closed or in undefined position Valve mechanism may get damaged if valve is in close or undefined position. Make sure that the valve is in open position secured.</p>

1. Mount protective covers on flanges; see chapter «4.2.1 Preparation for installation».
2. Pack valve appropriately, by using the original packaging material.



VAT disclaims any liability for damages resulting from inappropriate packaging.

10.2 Transport

	NOTICE
	<p>Inappropriate packaging Product may get damaged if inappropriate packaging material is used. Always use the original packaging material and handle product with care.</p>



VAT disclaims any liability for damages resulting from inappropriate packaging.

11 Disposal

Observe the local regulations for disposal

	⚠ WARNING
	<p>Harmful substances Environmental pollution. Discard products and parts according to the local regulations.</p>

	⚠ WARNING
	<p>Unqualified personnel Inappropriate handling may cause serious injury or property damage. Only qualified personnel are allowed to carry out the disposal.</p>

	⚠ CAUTION
	<p>Risk of damage Indicates a hazardous situation which, if not avoided, may result in minor or moderate injury. A large number of diverse materials are used in the product. Some of them could cause human and machine damage in the case of improper handling.</p> <ul style="list-style-type: none"> • Observe local regulations in regard to waste disposal without fail. • Commission an authorized waste disposal company for the professional disposal of your waste.

	NOTICE
	<p>Improper disposal Some built-in materials can cause damage, if improperly handled. - When disposing, take into account all the different materials used</p>

- | | |
|--|---|
| | <ul style="list-style-type: none"> • Hire an authorised waste disposal company to dispose of the waste in a professional manner. |
|--|---|

The following list should help you to dismantle your product without making serious errors and to properly separate out the product scrap.

Material groups	Hazard level
non-ferrous metals	high
stainless steel	low
aluminium	low
plastics	medium
lubricants	high
electronic scrap	high
batteries	very high
cables and wires	medium
motors	medium
seals and rubber parts	high

12 Spare parts

NOTICE	
	<p>Non-original spare parts Non-original spare parts may cause damage to the product. Use original spare parts from VAT only.</p>



- Please specify the fabrication number of the product when you place an order for spare parts; see chapter «1.1 Identification of product». This is to ensure that the appropriate spare parts are supplied.
- VAT makes a difference between spare parts that may be replaced by the customer and those that need to be replaced by the VAT service staff.
- The Item list only contains spare parts that may be replaced by the customer. If you need any other spare parts, please contact one of our service centers. You will find the addresses on our website www.vatvalve.com.

12.1 Valve Spare part list

Item	Description	Qty per Valve	Part / Ordering number	
			57040- .E14/E24/E34/E44	57044- .E14/E24/E34/E44
36/1	VATRING	1	39986-01	35774-01
36/2	Bonnet seal	1	51914-08	213816
36	Vacuum seal kit, consisting of VATRING and bonnet seal	1	83921-R1	215875
37	Pneumatic seal kit (Elastomer seals inside the pneumatic actuator)	1	232832	219947
60	Holding ring		99914-01	213794
64	Screw with venting hole		214314 / 15 Nm	214314 / 15 Nm
66	Treated hexagon socket head cap screw	12	N-5019-839 / 35 Nm	-
66	Treated hexagon socket head cap screw	16	-	N-5019-839 / 35 Nm

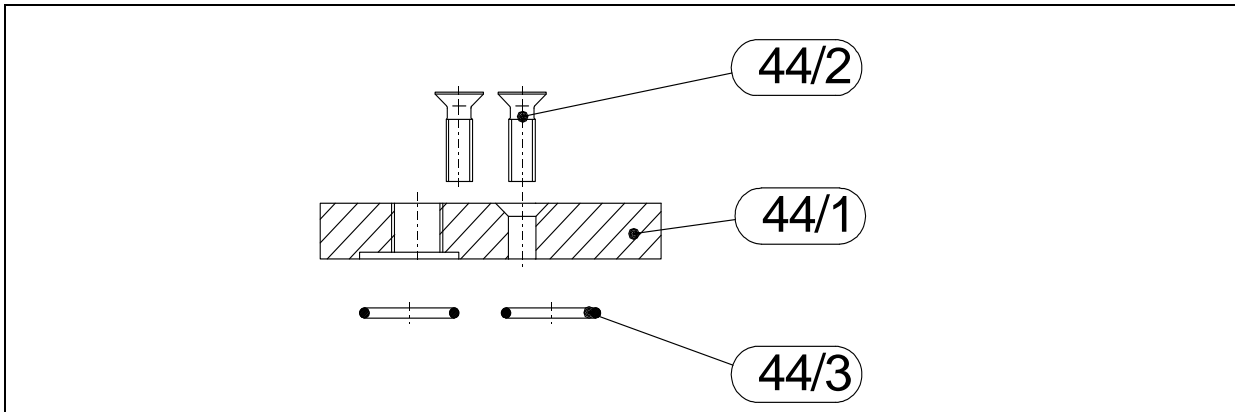
12.2 Air connection kit (solenoid on customer's site)

Item	Description	Version.	Qty	Part No.
44	Connection kit	Standard	1	81427-R1
		Actuator for 10 Gy	1	86069-R1
44/1	Plate		1	81428-01
44/2	Screw		2	N-6013-463
44/3	O-ring	Standard	2	N-7100-016
		Actuator for 10 Gy	2	N-7115-016

12.3 Solenoid kit (5/2-way standard)

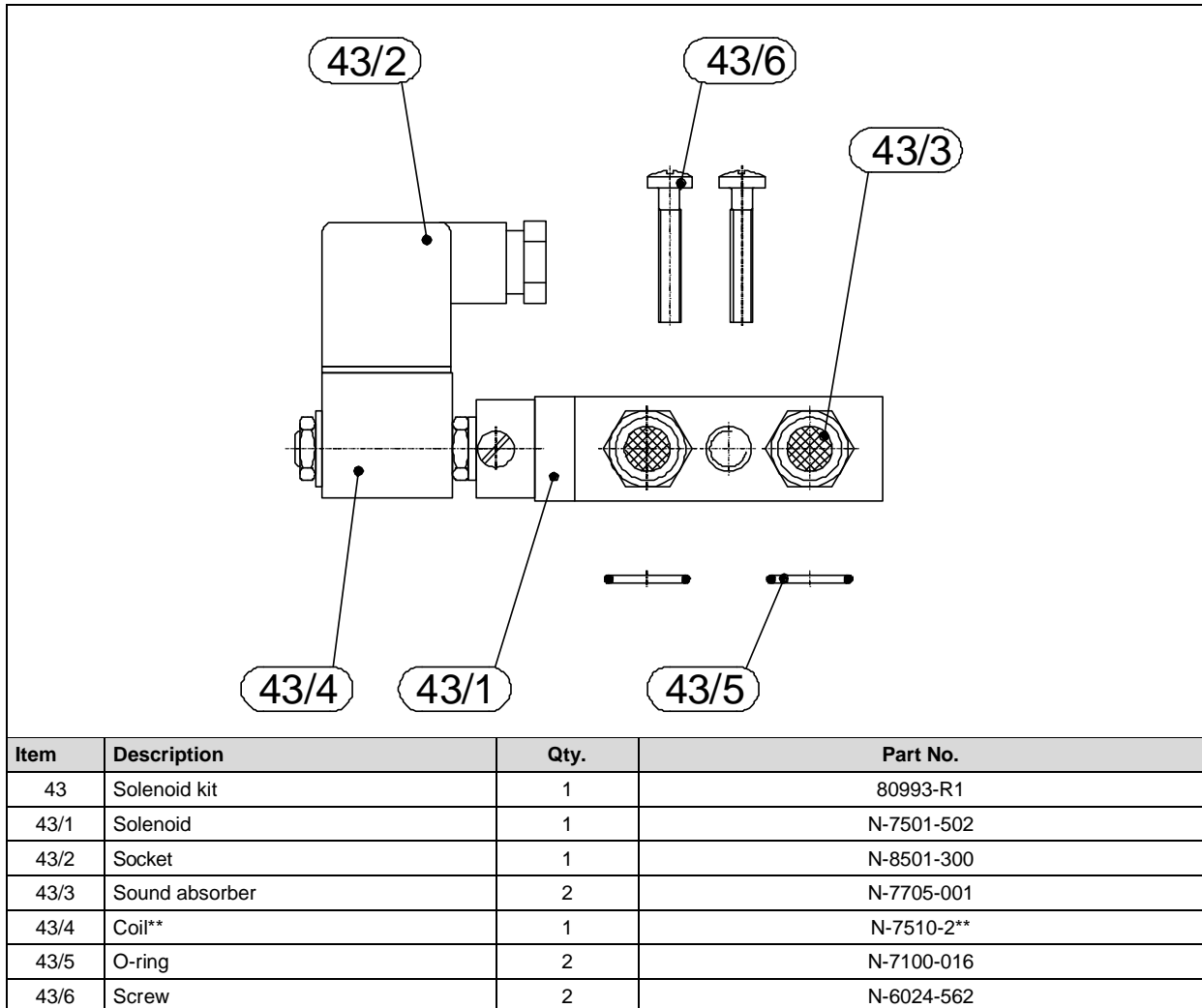

**) Specify voltage (e.g. N-7510-2-220V 50Hz)

12.4 Solenoid kit (5/2-way impulse actuation)

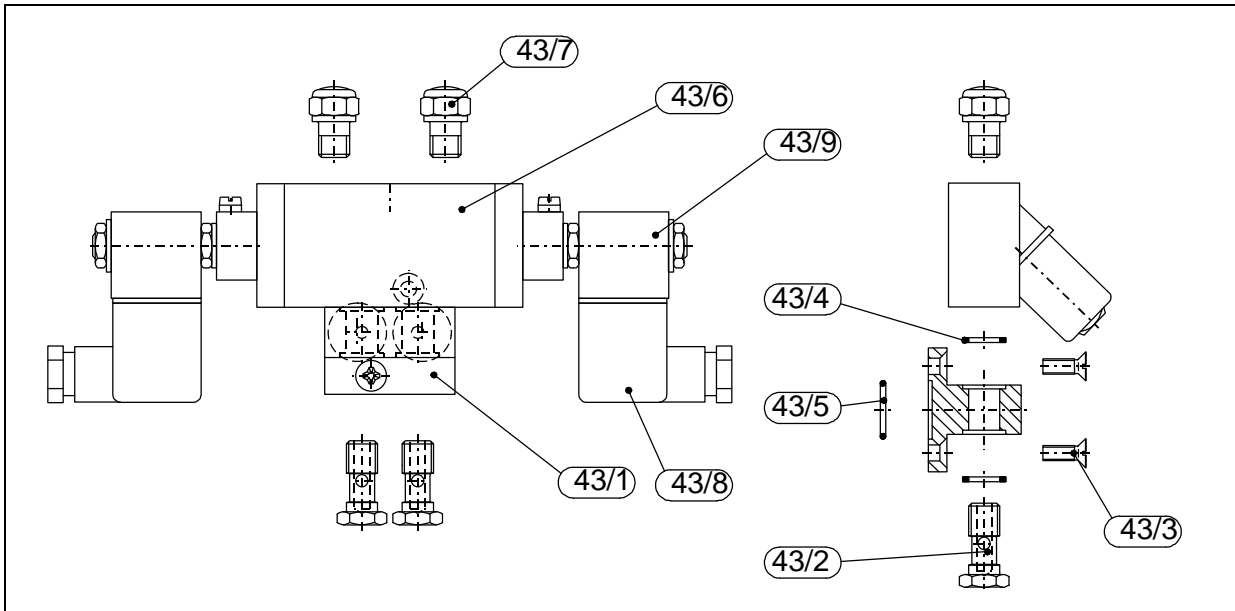

Item	Description	Qty.	Part No.
43	Solenoid kit	1	80993-R1
43	Solenoid kit	1	84569-R1
43/1	Connection plate	1	93708-01
43/2	Hollow screw	2	N-5060-010
43/3	Screw	2	N-6013-462
43/4	Gasket	4	N-7016-010
43/5	O-ring	2	N-7100-016
43/6	Solenoid	1	N-7502-504
43/7	Sound absorber	2	N-7705-001
43/8	Socket	2	N-8501-300
43/9	Coil**	2	N-7510-2**

** Specify voltage! (e.g. N-7510-2-220V 50Hz)

12.5 Position indicators 80°C (single + double) in various versions with adapter

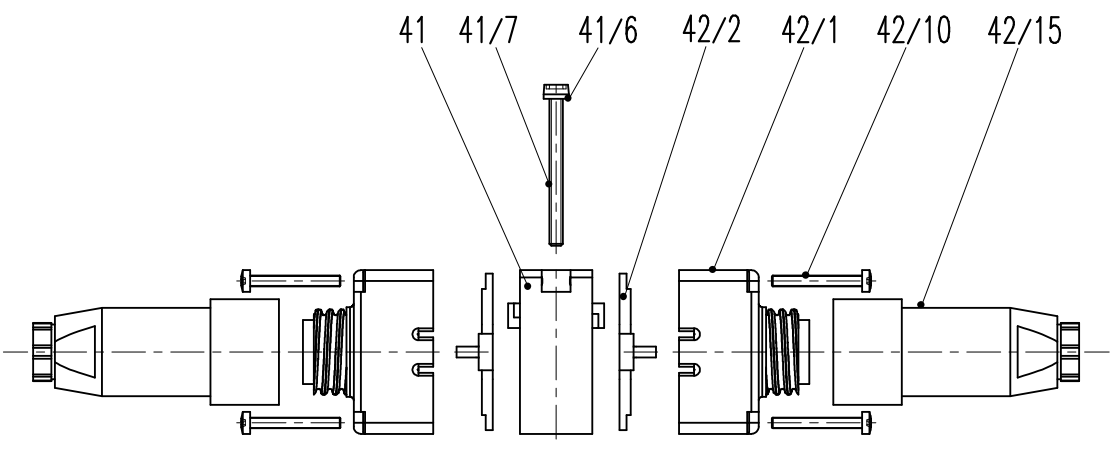

Item	Description	Version	Qty.		Part No.
			single	double	
41	Adapter complete		1	1	72228-R1 83923-R1
41/6	Spring ring		2	2	N-6162-404
41/7	Screw		2	2	N-6016-503
42	BS Mini position indicator	make contact switches	1	2	76664-R1
		double throw switches	1	2	85399-R1
		make contact radiation resistant	1	2	80074-R1
		double throw radiation resistant	1	2	83953-R1
		make contact switch with common plug for pos. indicator and solenoid	1	-	87997-R1
42/1	Position indicator	make contact switches	1	2	71852-R1
		double throw switches	1	2	70606-R1
		make contact radiation resistant	1	2	80075-R1
		double throw radiation resistant	1	2	83954-R1
		make contact switch with common plug for pos. indicator and solenoid	1	-	82560-R1
42/2	Slider		1	2	69846-01
42/10	Screw		4	8	N-6024-531
42/15	Socket		1	2	N-8504-002
	Cable socket, snaked		1	2	N-8504-005

12.6 Position indicators 200°C (single + double) with adapter

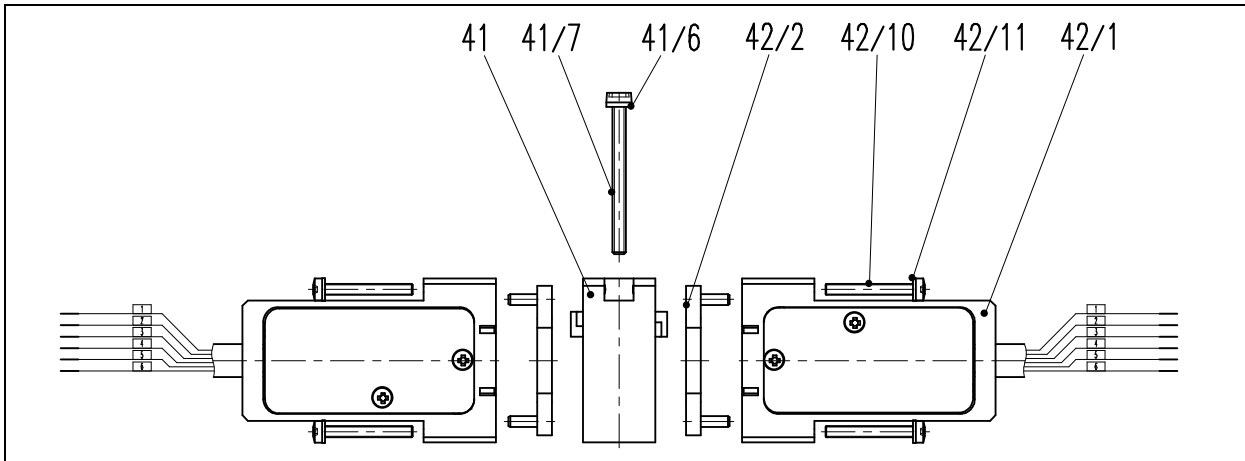

Item	Description	Version	Qty.		Part No.
			single	double	
41	Adapter complete		1	1	72228-R1 83923-R1
41/6	Spring ring		2	2	N-6162-404
41/7	Screw		2	2	N-6016-503
42	BS Mini position indicator	double throw switches	1	2	241823
42/1	Position indicator		1	2	241824
42/2	Slider		1	2	241825
42/10	Screw		4	8	N-6024-531
42/11	Spring ring		4	8	N-6160-406



13 Appendix

This Page Intentionally Left Blank