

RS232 / RS485

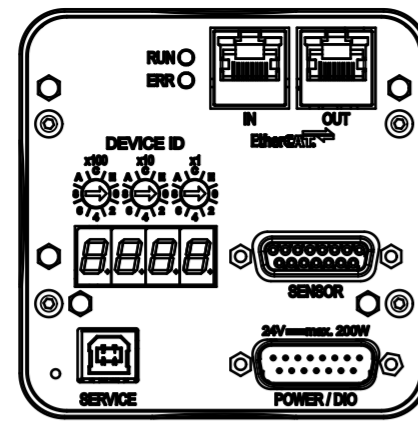

Ether CAT

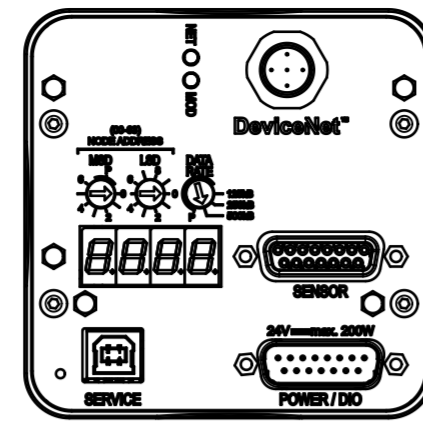

Device Net



CC-Link



Profibus



Ether NET



Position Only



Revision

Customer number

- ▼ Seat side
- ⊙ Comp. air connection
- ⊙ Electrical connection
- ⊙ Leak detection port
- ⊙ Mech. pos. indication
- ⊙ Position indicator
- ⊙ Required for dismantling
- ⊙ Emergency actuation
- ⊙ For attachment
- ⊙ Bake-out area
- ⊙ Differential pumping port

Control butterfly system
generic dimensional drawing for all 61.3 DN25 valves

VAT VAT Vakuumventile AG
CH-9469 Haag, Switzerland
Tel ++41 81 7716161 Fax ++41 81 7714830

Rev.-Date: 08.06.22
Visa: HUS

Series	613	Ordering No.	-
Projection E	DN	Flange	
	25		
Dimensional Drawing	1166515	Rev.	A



RS232 / RS485



Ether CAT



Device Net

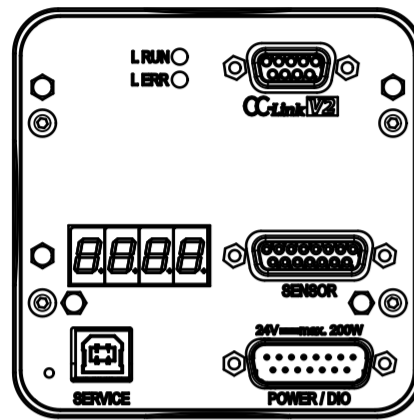

CC-Link

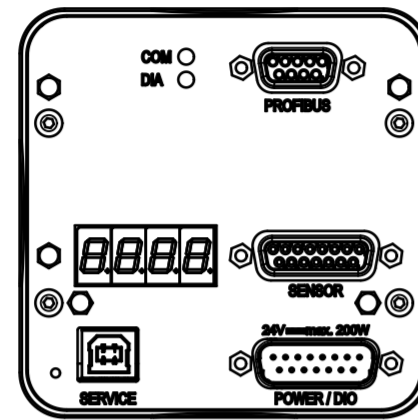

Profibus

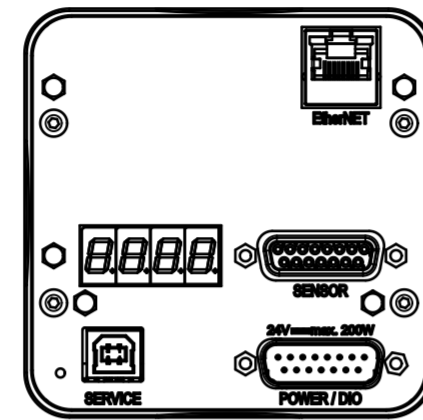

Ether NET

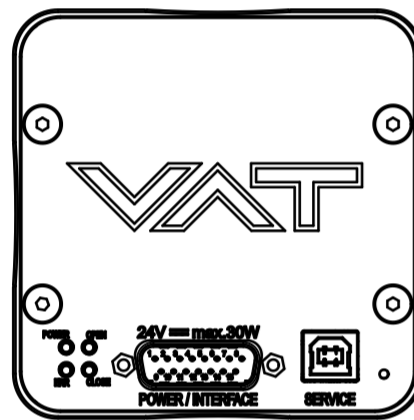

Position Only

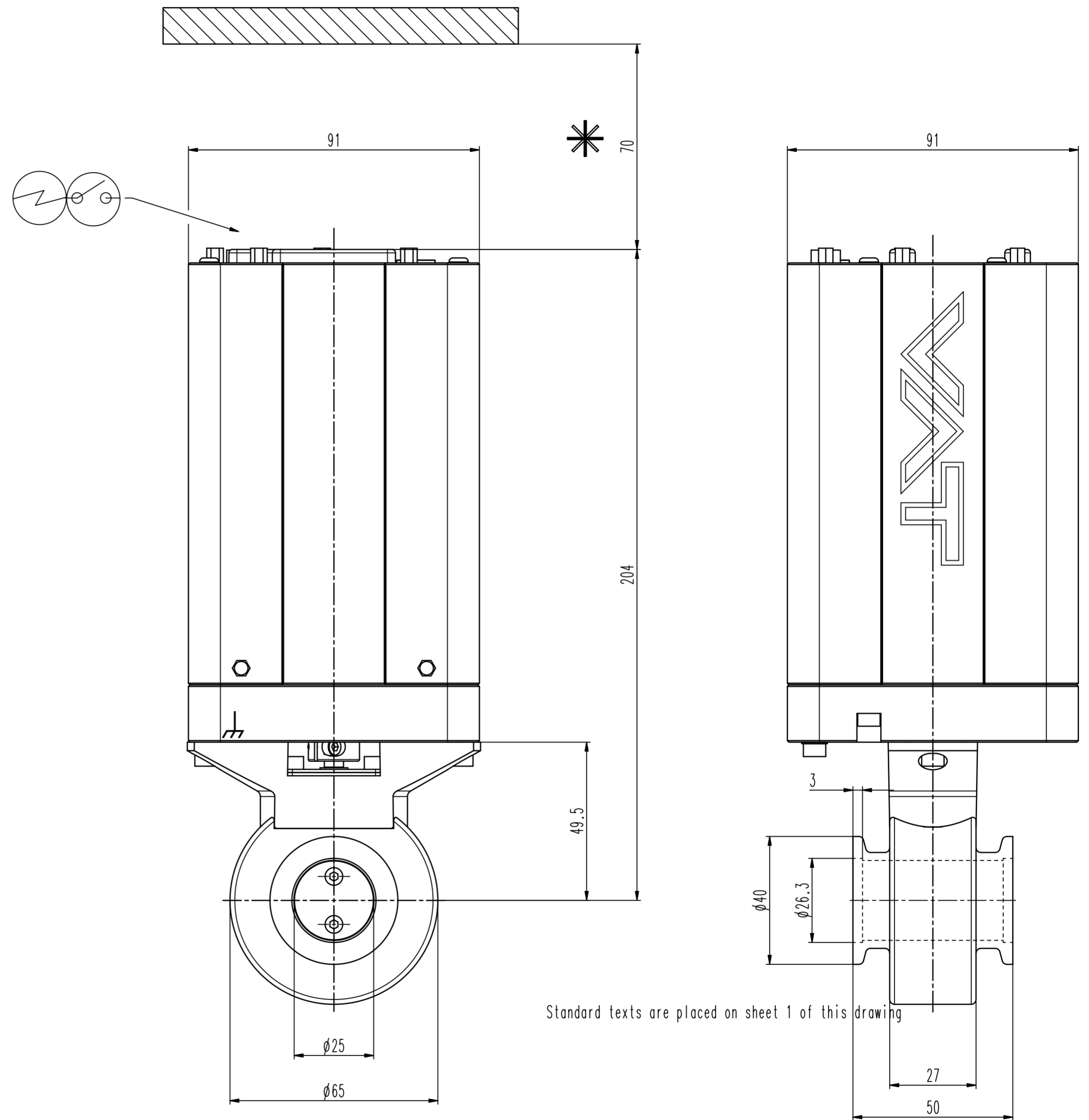

Standard texts are placed on sheet 1 of this drawing

Revision

Customer number

- ▼ Seat side
- ⊙ Comp. air connection
- ⊙ Electrical connection
- ⊙ Leak detection port
- ⊙ Mech. pos. indication
- ⊙ Position indicator
- ⊙ Required for dismantling
- ⊙ Emergency actuation
- ⊙ For attachment
- ⊙ Bake-out area
- ⊙ Differential pumping port

Control butterfly system
 RS232 interface / 2 sensors
 generic dimensional drawing for all 61.3 DN25 valves

VAT Vakuumentile AG
 CH-9469 Haag, Switzerland
 Tel ++41 81 7716161 Fax ++41 81 7714830

Rev.-Date: 08.06.22
 Visa: HUS

Series	613	Ordering No.	-
Projection	E	DN	Flange
⊙	⊙	⊙	ISO-KF
Dimensional Drawing	1166515	Rev.	A

IN WORK