

RS232 / RS485

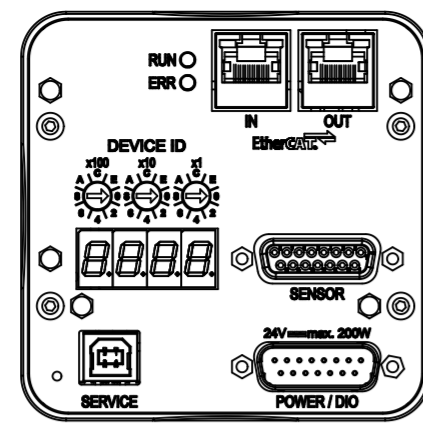

Ether CAT

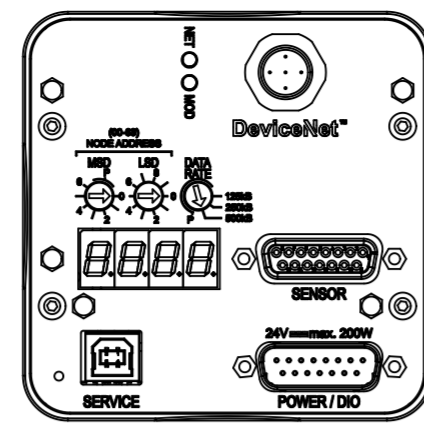

Device Net

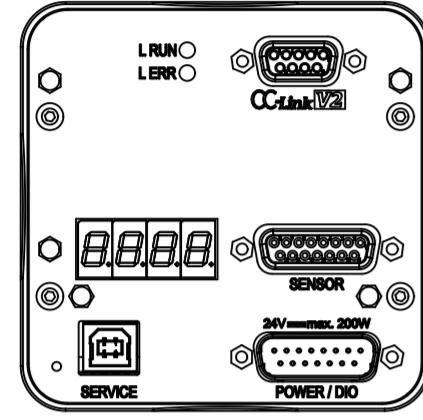

CC-Link

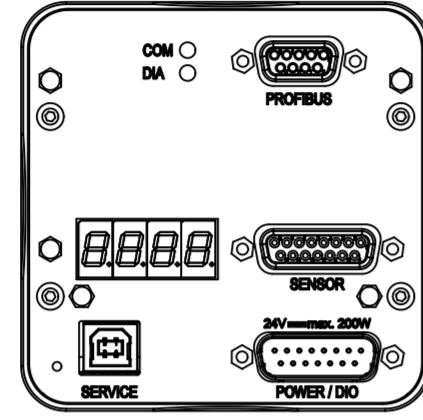

Profibus

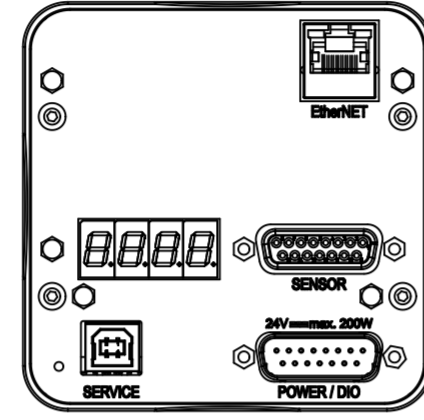

Ether NET

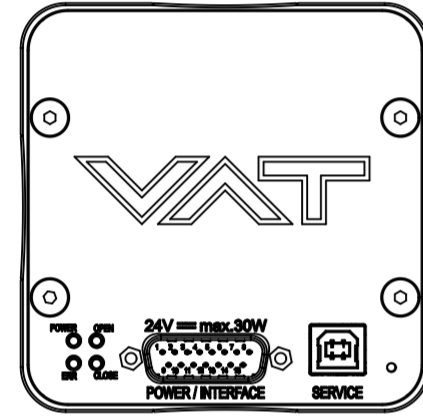

Position Only

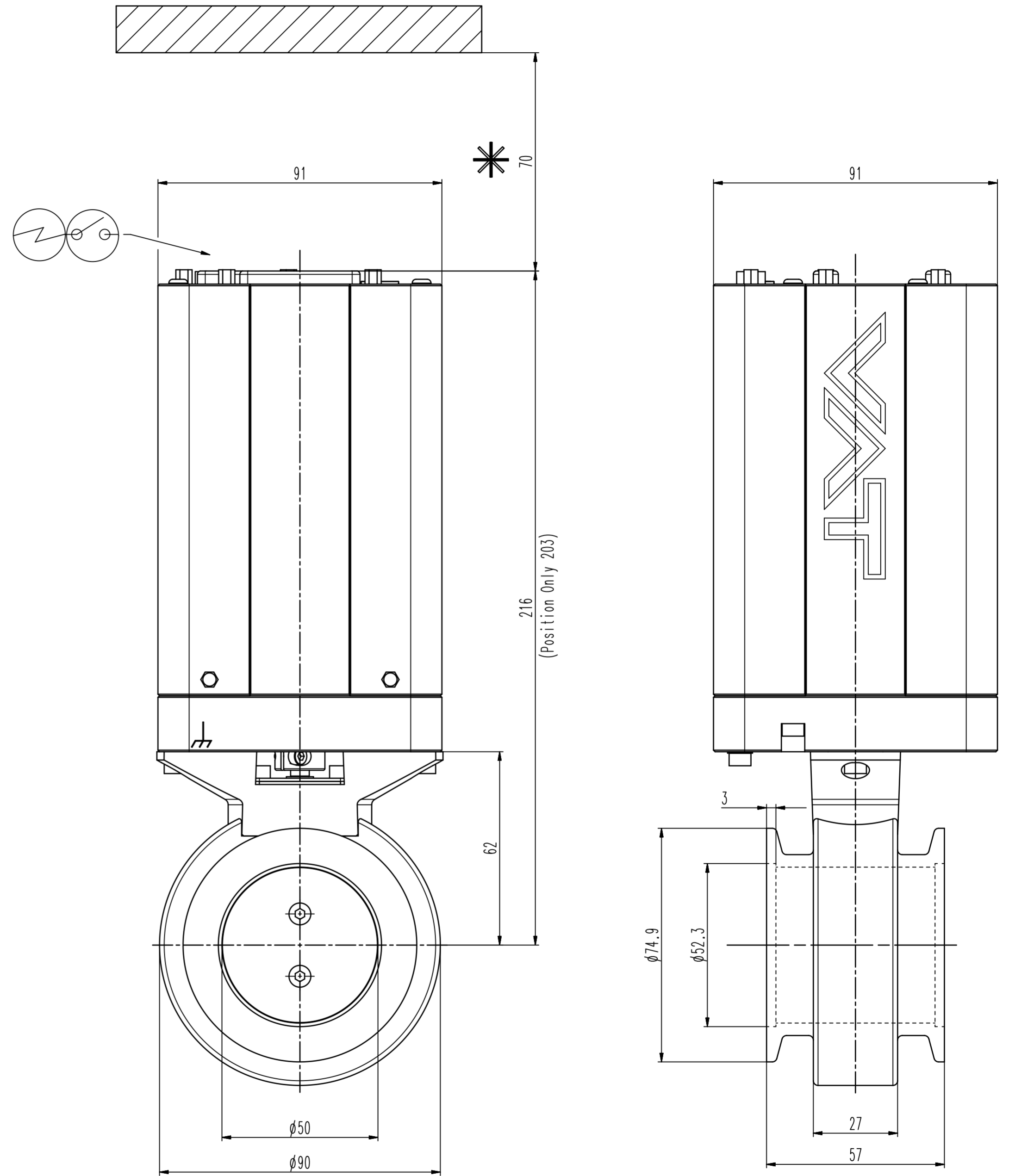
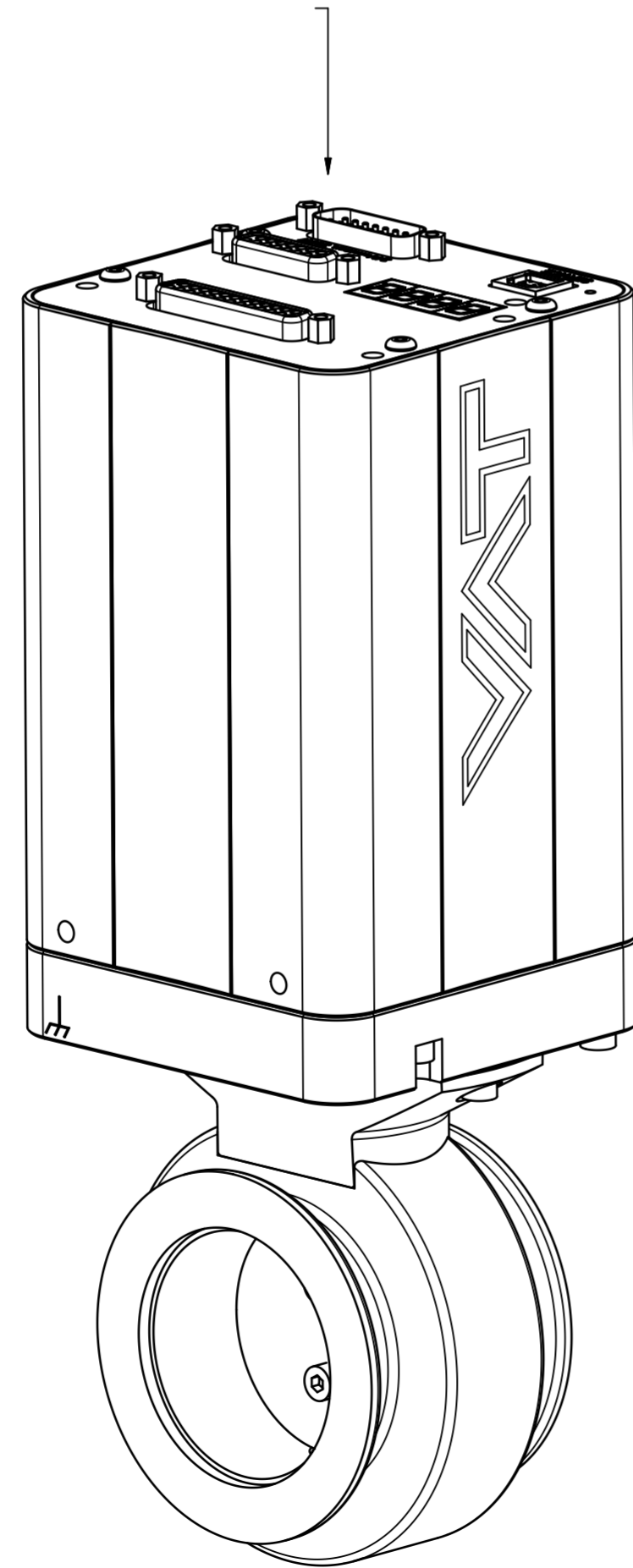

Revision  
Customer number

- ▼ Seat side
- ⊕ Comp. air connection
- ⊖ Electrical connection
- ⊗ Leak detection port
- ⊙ Mech. pos. indication
- ⊚ Position indicator
- ⊛ Required for dismantling
- ⊜ Emergency actuation
- ⊝ For attachment
- ⊞ Bake-out area
- ⊟ Differential pumping port

**Control butterfly system**  
generic dimensional drawing for all 613 DN50 valves

VAT Vakuumventile AG  
CH-9469 Haag, Switzerland  
Tel ++41 81 7716161 Fax ++41 81 7714830

Rev.-Date: 10.06.22  
Visa: HUS

Series	613	Ordering No.	-
Projection E	DN	Flange	
	50		
Dimensional Drawing	1166842	Rev.	A