

Butterfly Pressure Control Valve with EtherCAT interface

Series 613 DN 25-320 mm (I.D. 1" - 12")

This manual is valid for the valve ordering number(s):

613GX -	(2 sensor inputs)
613AX -	(2 sensor inputs / $\pm 15V$ SPS)
613HX -	(2 sensor inputs / PFO)
613CX -	(2 sensor inputs / $\pm 15V$ SPS / PFO)

SPS = Sensor Power Supply PFO = Power Failure Option

configured with firmware: **F01.0C.28.xx**

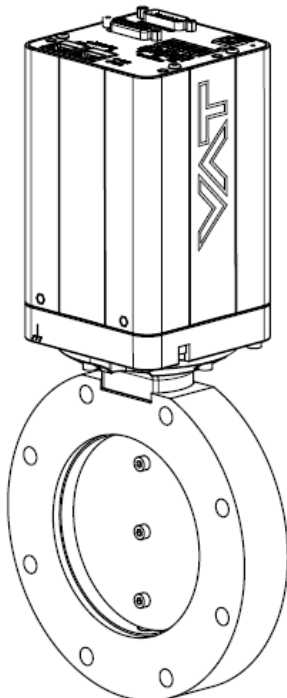

Sample picture

Imprint

Manufacturer VAT Vakuumventile AG, CH-9469 Haag, Switzerland

Website: www.vatvalve.com

Phone: +41 81 771 61 61

Fax: +41 81 771 48 30

Email: CH@vatvalve.com

Publisher VAT Vakuumventile AG, CH-9469 Haag, Switzerland

Editor VAT Vakuumventile AG, CH-9469 Haag, Switzerland

Print VAT Vakuumventile AG, CH-9469 Haag, Switzerland

Copyright © VAT Vakuumventile AG 2022

No part of these instructions may be reproduced in any way (photocopies, microfilms or any other reproduction processes) nor may it be manipulated with electronic systems, duplicated or distributed without written permission from VAT. Offenders are liable to pay damages.

The original VAT firmware and updated state of the art versions of the VAT firmware are intended for use with VAT products. The VAT firmware contains a limited, time unlimited user license. The VAT firmware may not be used for purposes other than those intended nor is it permitted to make copies of the VAT firmware. In particular, it is strictly forbidden to give copies of the VAT firmware to other people.

The use of trade names, brand names, trademarks, etc. in these Instructions does not entitle third parties to consider these names to be unprotected and to use them freely. This is in accordance with the meaning of the laws and acts covering brand names and trademarks.

Contents

1	Description of product.....	6
1.1	Identification of product	6
1.2	Firmware	6
1.3	Use of product.....	6
1.4	Used abbreviations.....	6
1.5	Related documents.....	6
1.6	Important information.....	6
1.7	Technical data	7
1.7.1	Control and actuating unit	7
1.7.2	Valve unit	7
2	Safety	8
2.1	Compulsory reading material.....	8
2.2	Danger levels	8
2.3	Personnel qualifications.....	9
2.4	Safety labels.....	9
3	Design and Function.....	10
3.1	Design	10
3.2	Function.....	10
3.2.1	Pressure control system overview and function	11
3.2.2	Principle of a pressure control system	12
4	Installation	13
4.1	Initial procedure.....	13
4.2	Unpacking	14
4.3	Installation into the system	15
4.3.1	Installation Hints.....	16
4.3.2	Installation space condition	16
4.3.3	Admissible forces	17
4.3.4	Admissible forces at controller	18
4.3.5	Tightening torque DN40 – 50mm	19
4.3.6	Tightening torque DN63 – 100mm	20
4.4	Connection overview	21
4.5	Power-, Ground- and Sensor Connection.....	22
4.5.1	Connection cable recommendations	22
4.5.2	Ground connection.....	23
4.5.3	Power and Sensor supply concepts.....	24
4.5.4	Drive Power Enabled Switch, Safety Mode.....	28
4.6	Power Up.....	29
4.7	Power Down, Power Failure Option	29
4.7.1	Power down behavior in case of power failure.....	29
4.7.2	Power Fail Option	29
4.8	Service Port, CPA software	30
4.8.1	How to start.....	30
4.8.2	Update	31
4.9	Display Information.....	32
4.9.1	Power up.....	32
4.9.2	Operation	33
4.9.3	Error	33
4.10	System Settings and States	34
4.10.1	Identification.....	34
4.10.2	Statistics.....	35
4.10.3	Warning/Error.....	36
4.10.4	Service.....	36
4.11	Valve Settings and States	37
4.11.1	States.....	37

4.11.2	Homing	37
4.11.3	Cycle Counter.....	38
4.11.4	Position Restriction.....	38
4.11.5	Position Adaption	39
4.12	Interface EtherCAT	40
4.12.1	Connection	40
4.12.2	Device identification, Rotary switches	41
4.12.3	LEDs	42
4.12.4	Connection Loss Reaction	43
4.12.5	Position and Pressure Units	44
4.12.6	ESI File.....	45
4.12.7	Communication failure.....	45
4.12.8	PDO Process data objects – cyclic communication.....	46
4.12.9	SDO Service data objects – acyclic communication.....	52
4.13	Pressure Sensor	70
4.13.1	Mechanical connection requirements	70
4.13.2	Configuration	71
4.13.3	Crossover (2 sensor operation mode)	73
4.13.4	Zero Adjust.....	74
4.13.5	Logarithmic Pressure	75
4.14	Power Connector Digital IO	76
4.14.1	Digital Input	76
4.14.2	Digital Output.....	77
5	Operation.....	78
5.1	Access Mode	79
5.1.1	Overview	79
5.1.2	Remote and Locked operation	79
5.1.3	Local operation.....	79
5.2	Control Mode	80
5.2.1	View	81
5.3	Pressure Control.....	82
5.3.1	Controller units	82
5.3.2	Control algorithm	83
5.3.3	Adaptive algorithm.....	85
5.3.4	PI algorithm	96
5.3.5	Pressure Ramp	102
5.3.6	Profile Ramp	105
5.3.7	Automated Controller Selector	108
5.3.8	Control Position Restriction	109
5.3.9	Store Control Parameter Volatile.....	109
5.4	Position Control	110
5.4.1	Parameter	110
5.4.2	Position Ramp.....	110
5.5	Operation under increased temperature	111
6	Trouble shooting	112
6.1	Warnings	112
6.2	Errors.....	114
6.2.1	Error Recovery	114
6.2.2	Error Bitmap	114
6.2.3	Error Number.....	115
6.2.4	Error Code.....	115
6.3	Troubleshooting List	117
7	Maintenance	118
7.1	Maintenance intervals.....	118
7.2	Maintenance procedures	119
7.2.1	Replacement of shaft feedthrough seals and valve cleaning	120
7.2.2	Replacement of Option board	124

8	Repairs	129
8.1	FPR Service	129
9	Dismounting and Storage.....	130
9.1	Dismounting	130
9.2	Storage.....	131
10	Packaging and Transport	132
10.1	Packaging.....	133
10.2	Transport.....	133
11	Disposal	134
12	Spare parts	135
12.1	ISO-KF for DN 25 – 50 mm	136
12.1.1	Drawing ISO-KF	136
12.1.2	ISO-KF valve unit - aluminum blank, without heating.....	137
12.1.3	ISO-KF valve unit – stainless steel, without heating	137
12.1.4	Seals and grease	137
12.2	ISO-F for DN 63 – 320 mm.....	138
12.2.1	Drawing ISO-F	138
12.2.2	ISO-F valve unit - aluminum blank, without heating.....	139
12.2.3	ISO-F valve unit – stainless steel, without heating.....	139
12.2.4	Seals and grease	139
12.3	Control unit and Accessories.....	140
12.3.1	Control and actuating unit	140
12.3.2	Accessories.....	140
12.3.3	Centering ring with VITON ® O-ring.....	140

1 Description of product

1.1 Identification of product

The fabrication number and order number are fixed on the product directly or by means of an identification plate.

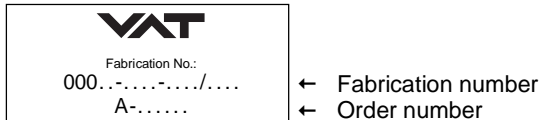

1.2 Firmware

Please look up the firmware version in the CPA or read it from the display at start up.
 Location: CPA/Parameters: System.Identification.Firmware

1.3 Use of product

This product is a Butterfly control valve for downstream pressure control in vacuum systems. Use product for clean and dry vacuum applications only. Other applications are only allowed with the written permission of VAT.

1.4 Used abbreviations

Abbreviation	Description
CPA	Control Performance Analyzer
PFO	Power Failure Option
SFS	Sensor Full Scale
SPS	Sensor Power Supply
ADC	Analog-to-digital converter

1.5 Related documents

- Product Data Sheet
- Dimensional Drawing
- IOMI Heating device (if valve with heater)

1.6 Important information



This symbol points to a very important statement that requires particular attention.

Example:



Refer to chapter: «Technical data» for detailed information.

1.7 Technical data

1.7.1 Control and actuating unit



See product data sheet.

1.7.2 Valve unit



See product data sheet.

2 Safety

2.1 Compulsory reading material

Read this chapter prior to performing any work with or on the product. It contains important information that is significant for your own personal safety. This chapter must have been read and understood by all persons who perform any kind of work with or on the product during any stage of its serviceable life.

	NOTICE
	<p>Lack of knowledge Failing to read this manual may result in property damage. Firstly, read manual.</p>





These Installation, Operating & Maintenance Instructions are an integral part of a comprehensive documentation belonging to a complete technical system. They must be stored together with the other documentation and accessible for anybody who is authorized to work with the system at any time.

2.2 Danger levels

	⚠ DANGER
	<p>High risk Indicates a hazardous situation which, if not avoided, will result in death or serious injury.</p>

	⚠ WARNING
	<p>Medium risk Indicates a hazardous situation which, if not avoided, could result in death or serious injury.</p>

	⚠ CAUTION
	<p>Low risk Indicates a hazardous situation, which if not avoided, may result in minor or moderate injury.</p>

	NOTICE
	<p>Command Indicates a hazardous situation, which if not avoided, may result in property damage.</p>

2.3 Personnel qualifications

	WARNING
	Unqualified personnel Inappropriate handling may cause serious injury or property damage. Only qualified personnel is allowed to carry out the described work.

2.4 Safety labels

Label	Part No.	Location on valve
	T-9001-156	On protective foil covering of valve opening

3 Design and Function

3.1 Design

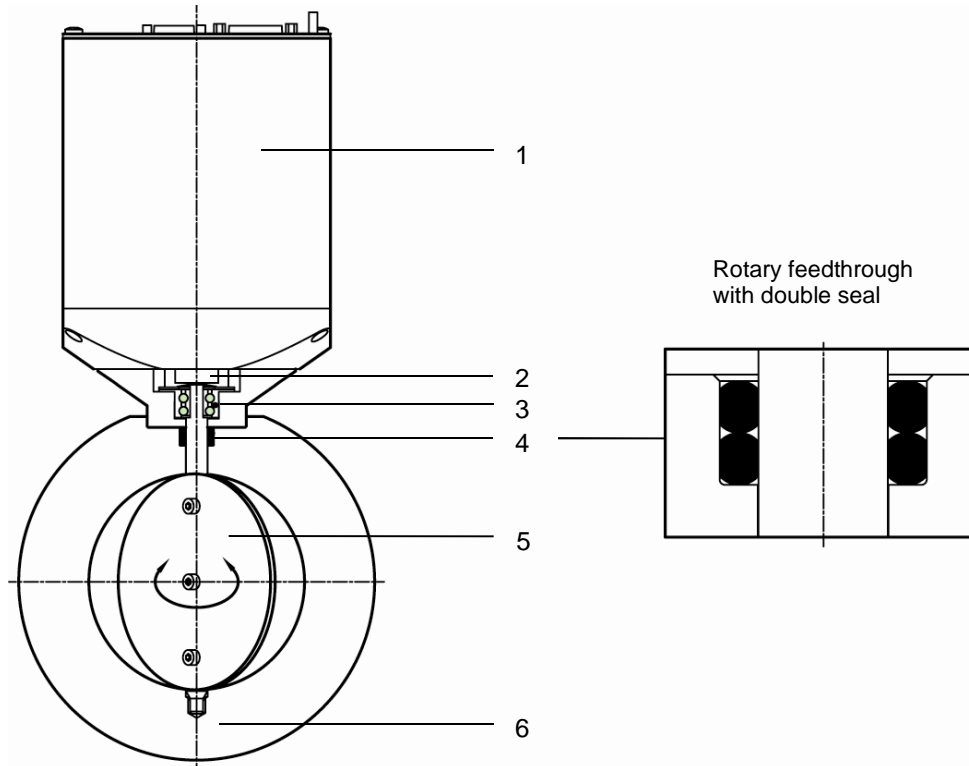

- | | | | |
|---|-----------------------|---|-------------|
| 1 | Integrated controller | 4 | Double seal |
| 2 | Coupling | 5 | Plate |
| 3 | Bearing | 6 | Valve body |

3.2 Function

The valve plate (5) acts as a throttling element and varies the conductance of the valve opening. The integrated controller (1) calculates the required plate position to achieve the setpoint pressure. See also principle drawing on chapter: «Connection Overview». Actuation is handled by a stepper motor with an encoder monitoring the position. This principle ensures very fast and accurate process pressure control even in demanding contaminating processes.

3.2.1 Pressure control system overview and function

Vacuum pressures are always absolute pressures unless explicitly specified as pressure differences.

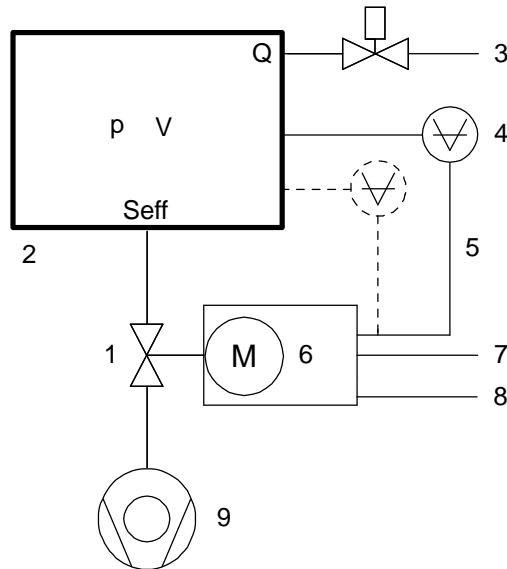

- 1 Valve
- 2 Process chamber
- 3 Gas inlet
- 4 Pressure sensor(s)
- 5 Sensor cable
- 6 Controller and actuator
- 7 Cable to remote control unit
- 8 Cable to power supply
- 9 HV Pump

$S_{eff} = Q / p$

S_{eff} effective pump speed ($l s^{-1}$)

Q Gas flow (mbar)

p Pressure (mbar)

or units used in USA

$S_{eff} = 12.7 \cdot Q / p$

S_{eff} effective pump speed ($l s^{-1}$)

Q Gas flow (sccm)

p Pressure (mTorr)

Example: Downstream control

3.2.1.1 Way of operation

The controller compares the actual pressure in the process chamber given by the pressure sensor with the preset pressure. The controller uses the difference between actual and set pressure to calculate the correct position of the control valve. The controller drives the control valve into the correct position and the actual pressure again equals the set pressure. This control operation is performed continuously. Pressure changes in the process chamber due to leaks, desorption, and gas flow, reaction products, variations in pumping speed etc. are always corrected at once.

3.2.1.2 Pressure control

In a vacuum system which is pumped and into which gas is admitted at the same time, the pressure can be controlled in two ways:

1. Downstream control (standard):
The pressure is controlled by changing the conductance of a control valve between pump and process chamber. This changes the effective pumping speed at the process chamber. Pressure and gas flow can be independently controlled over a wide range.
2. Upstream control:
The pressure is controlled by changing the gas flow into the process chamber, while the pumping speed remains constant.

3.2.1.3 Adaptive controller (standard)

A controller adapting itself to changes in pressure, gas flow and pumping speed without any manual adjustments. This allows for a completely automatic operation of the system.

3.2.2 Principle of a pressure control system

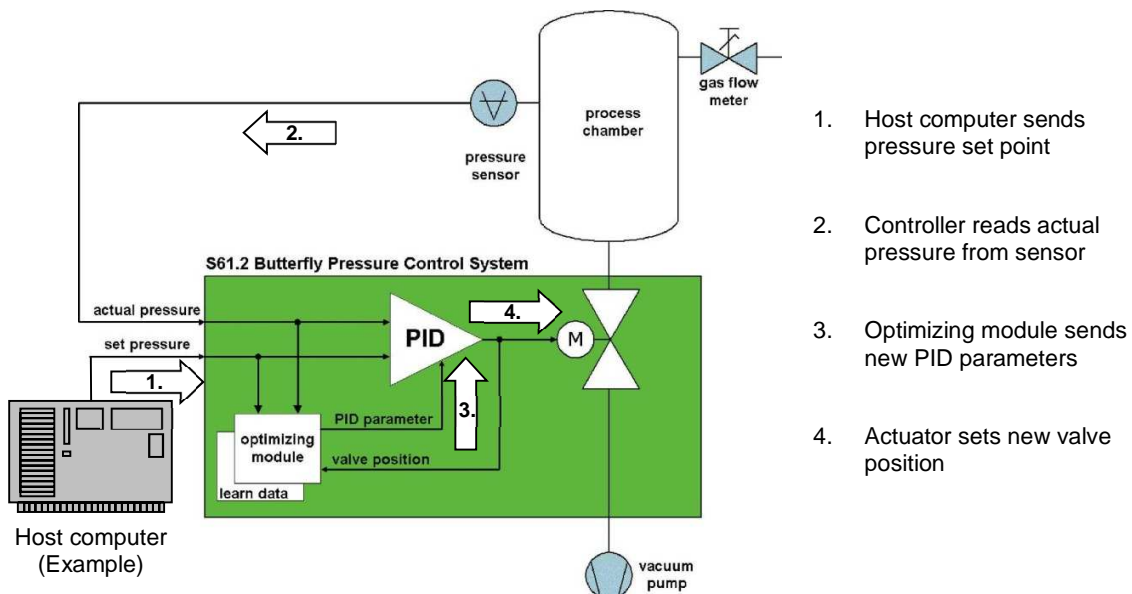

4 Installation

	WARNING
	<p>Unqualified personnel Inappropriate handling may cause serious injury or property damage. Only qualified personnel are allowed to carry out the described work.</p>

4.1 Initial procedure

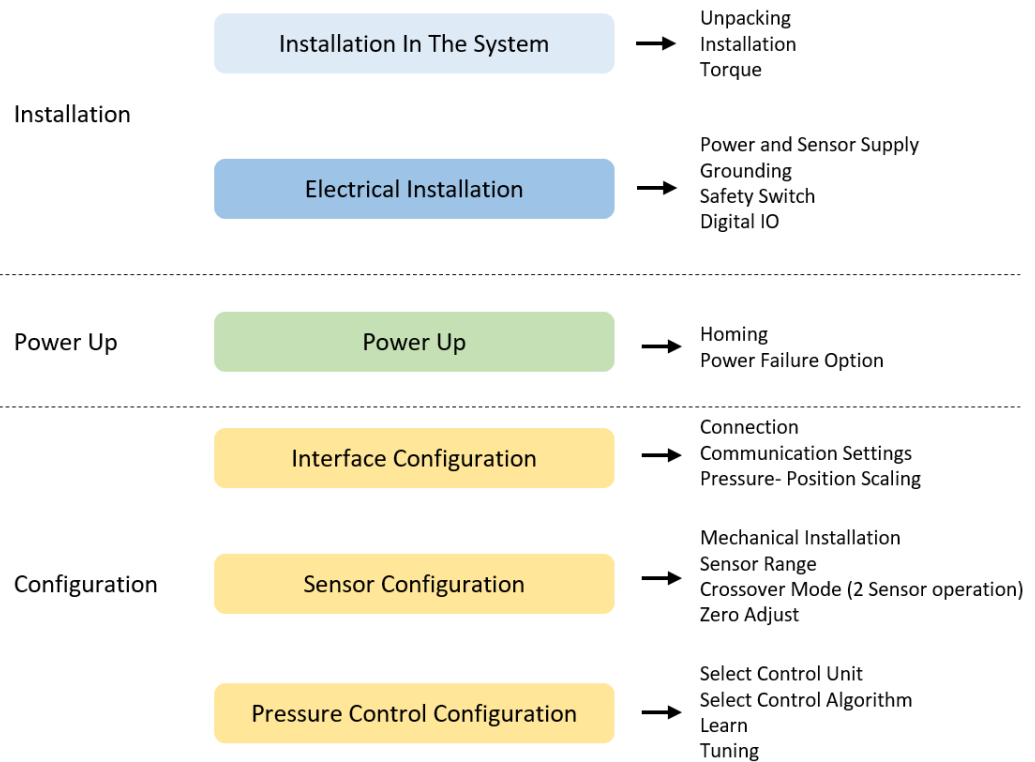

4.2 Unpacking

	NOTICE
	<p>Physical overstraining at controller Inappropriate handling with the valve may cause in damage of controller. Do not place the valve on the controller.</p>

	NOTICE
	<p>Physical overstraining at pedestal Inappropriate handling with the valve may cause in damage of pedestal. Lift valve at valve body out of transport case.</p>



- Make sure that the supplied products are in accordance with your order.
- Inspect the quality of the supplied products visually. If it does not meet your requirements, please contact VAT immediately.
- Store the original packaging material. It may be useful if products must be returned to VAT.

1. Open the transport case and remove inside packing material as far as necessary.
2. Lift the valve carefully and place it on a clean place.





Do not remove protective foils from valve opening

4.3 Installation into the system

	⚠ WARNING
	<p>Valve opening Risk of serious injury. Human body parts must be kept out of the valve opening and away from moving parts. Do not connect the controller to power before the valve is installed complete into the system.</p>

	NOTICE
	<p>Sealing surfaces Sealing surfaces of valve and vacuum system could be damage in case of incorrect handling. Only qualified personal are allowed to install the valve into the vacuum system.</p>

	NOTICE
	<p>Wrong connection Wrong connection may result in damage of controller or power supply. Connect all cables exactly as shown in the following descriptions and schematics.</p>

	NOTICE
	<p>Burned connector pins (spark) Connector pins or electronic parts could damage, if plugged and unplugged under power. Do not plug or unplug connectors under power.</p>

	NOTICE
	<p>Contamination Gate and other parts of the valve must be protected from contamination. Always wear clean room gloves when handling the valve.</p>

 Mount valve to a clean system only.

4.3.1 Installation Hints

Install valve into the vacuum system. Valve seat side shall face process chamber.



- Do not tighten the flange screws stronger than indicated under chapter «Tightening torque».
- Do not admit higher forces to the valve than indicated under chapter «Admissible forces».
- Make sure that enough space is kept free to do preventive maintenance work. The required space is indicated on the dimensional drawing.
- Control unit of valves with ISO-KF (61... – K...) needs support when mounted on horizontal piping and control unit does not hang.

4.3.2 Installation space condition



Install the valve with integrated controller with space for dismantling and air circulation as shown in figure below.

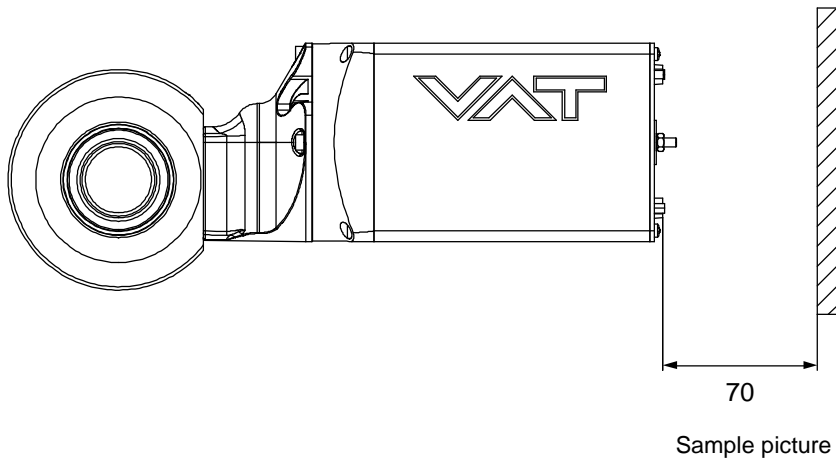

4.3.3 Admissible forces



NOTICE

Force at valve body

Forces from the weight of other components can lead to deformation of the valve body and to malfunction of the valve.

Do not higher force the valve body as specified.

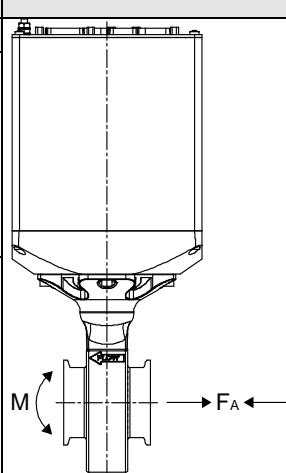
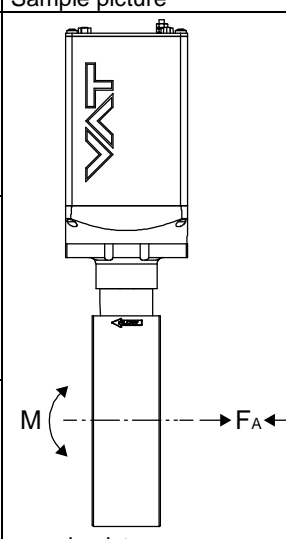

The following forces are admissible.

Valve size		Axial tensile or compressive force «F _A »		Bending moment «M»		
mm	inch	N	lb.	Nm	lbf.	
40	1½	100	22	6	4.5	 <p>Sample picture</p>
50	2	150	34	11	8	
63	2½	800	176	32	24	 <p>sample picture</p>
80	3	850	187	35	26.5	
100	4	1000	220	40	30	

4.3.4 Admissible forces at controller

NOTICE	
	<p>Force at pedestal</p> <p>In case higher force is applied, the pedestal could be permanently damaged.</p> <ul style="list-style-type: none"> - Do not pushing, shocking load, or stressing the valve controller - Do not deposit anything at valve controller

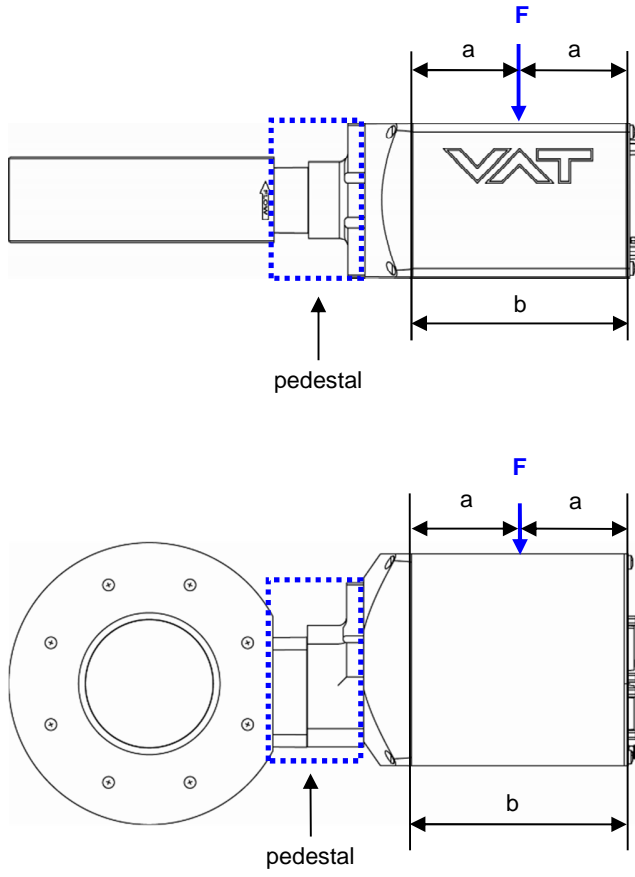

The admissible force at valve controller in regards to the pedestal is shown in table below

Admissible force «F»	Overview F = Force a = middle of aluminum part of controller (b / 2)
400 N	 <p style="text-align: center;">sample pictures</p>

4.3.5 Tightening torque DN40 – 50mm

Tightening torques for ISO-KF flange connections depend on the type of seal which is used. Follow recommendations of seal manufacturer.

4.3.5.1 ISO-KF Clamping connections

Clamping chain (example)

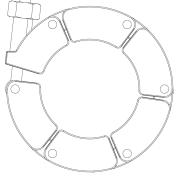
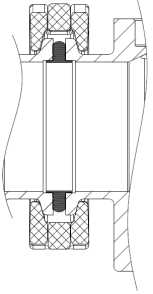
Valve size	ISO-KF	ISO-KF	 e.g.: 31032-KASA-0001 31034-KASA-0001	
	recommended tightening torque (Nm)	recommended tightening torque (lbs . ft)		
DN40 / 1½ "	5	3.7		
DN50 / 2"	6	4.5		

Clamping device (example)

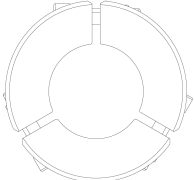
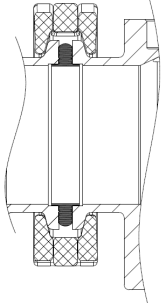
Valve size	ISO-KF	ISO-KF	 e.g.: 31032-KASE-0001 31034-KASE-0001	
	recommended tightening torque (Nm)	recommended tightening torque (lbs . ft)		
DN40 / 1½ "	12	9		
DN50 / 2"	12	9		

4.3.6 Tightening torque DN63 – 100mm

Tighten mounting screws of the flanges uniformly in crosswise order. Observe the maximum torque levels in the following table. Higher tightening torques deforms the valve body and may lead to malfunction of the valve.

4.3.6.1 Mounting of CF-F flanges

Tightening torques for CF-F flange connections depend on the type of seal which is used. Follow recommendations of seal manufacturer.

4.3.6.2 Mounting with centering rings

Valve size	ISO-F	ISO-F
	max. tightening torque (Nm)	max. tightening torque (lbs . ft)
DN63 / 2½ "	8-10	6-8
DN80 / 3"	8-10	6-8
DN100 / 4"	8-10	6-8
	hole depth (mm)	hole depth (inch)
DN63 / 2½ "	12	0.47
DN80 / 3"	12	0.47
DN100 / 4"	12	0.47

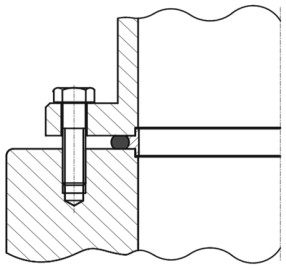

Refer to «Spare parts / Accessories» for centering rings ordering numbers.

4.3.6.3 Mounting with O-ring in grooves

Valve size	ISO-F	JIS	ASA-LP	ISO-F	JIS	ASA-LP
	max. tightening torque (Nm)			max. tightening torque (lbs . ft)		
DN63 / 2½ "	20-23	35-40	35-40	15-17	26-30	26-30
DN80 / 3"	20-23	35-40	35-40	15-17	26-30	26-30
DN100 / 4"	20-23	35-40	35-40	15-17	26-30	26-30
	hole depth (mm)			hole depth (inch)		
DN63 / 2½ "	12	n/a	n/a	0.47	n/a	n/a
DN80 / 3"	12	n/a	n/a	0.47	n/a	n/a
DN100 / 4"	12	n/a	n/a	0.47	n/a </td <td>n/a</td>	n/a

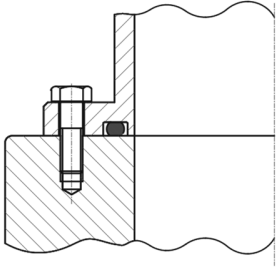



Make sure that screws in use are capable to withstand applied torques.

4.4 Connection overview

Controller IC2-H3:

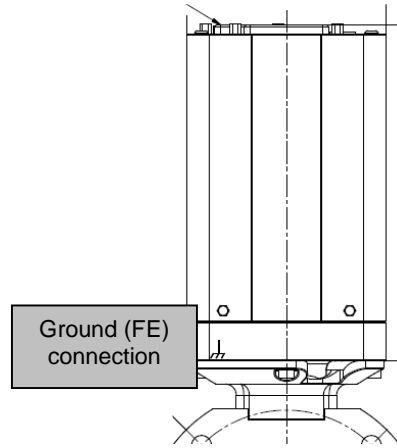
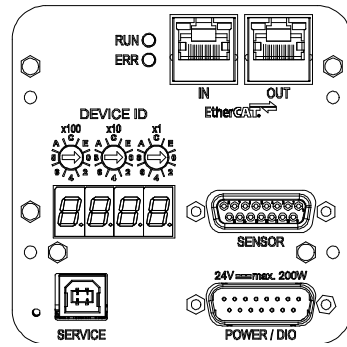
EtherCat



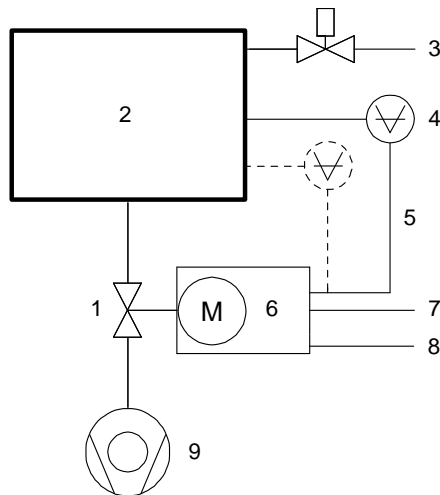

System:



- 1 Valve
- 2 Process chamber
- 3 Gas inlet
- 4 Pressure sensor(s)
- 5 Sensor cable(s)
- 6 Controller and actuator
- 7 Cable to remote control unit
- 8 Cable to power supply
- 9 Pump

4.5 Power-, Ground- and Sensor Connection

NOTICE	
	<p>Wrong connection</p> <p>Wrong connection may result in damage of controller or power supply. Connect all cables exactly as shown in the following descriptions and schematics.</p>

NOTICE	
	<p>Burned connector pins (spark)</p> <p>Connector pins or electronic parts could damage, if plugged and unplugged under power. Do not plug or unplug connectors under power.</p>

4.5.1 Connection cable recommendations

For Power Supply connection cables, VAT recommends:

Class (min.)	L (Length max.)	d (diameter)
AWG18 (shielded)	5 m	0.823 mm ²

For Sensor & Signal connection cables, VAT recommends:

Class (min.)	L (Length max.)	d (diameter)
AWG22 (shielded)	20 m	0.326 mm ²

4.5.2 Ground connection

Recommendation for ground connection between controller and system chassis with cable or with ground strap.

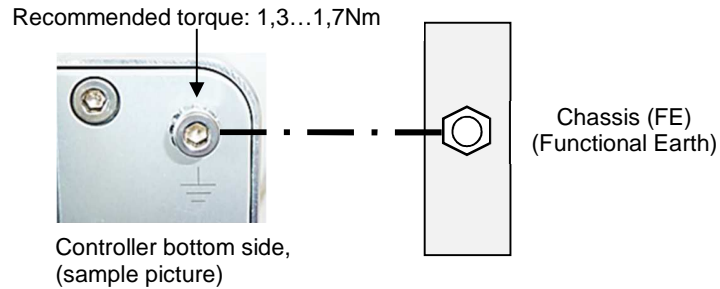

- Recommendation for ground connection cable: AWG 12 (4 mm²)
- The connection point at chassis (FE) must be blank metal (not coated).

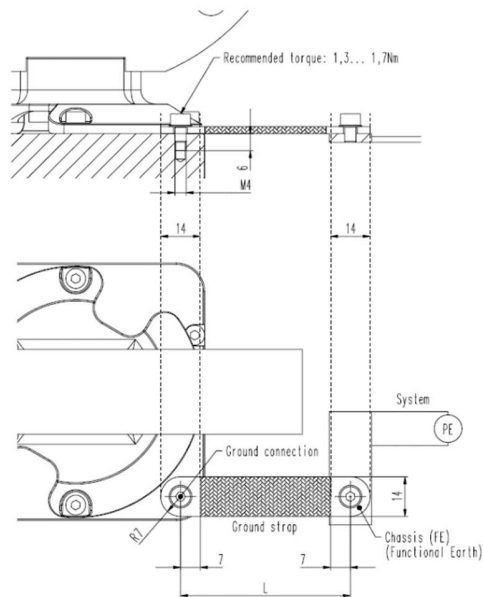

- Connection plates of ground strap must be total plane for a good electrical contact!
- The connection point at chassis (FE) must be blank metal (not coated). It is also possible to connect the ground strap at system chamber if it is well connected to PE.
- Avoid low chassis cross section to the system PE connection. (min. same cross section as ground strap)

4.5.3 Power and Sensor supply concepts

This valve offers 3 alternative concepts to supply the sensor(s) with power. This depends on the sensor type and valve version that is used.

Concepts:

24 VDC sensors:

- External +24 VDC supplied to POWER connector is feedthrough to SENSOR connector. Refer to chapter «Power and sensor connection (+24 VDC sensors) ».

±15 VDC sensors:

- External ±15 VDC supplied to POWER connector is feedthrough to SENSOR connector. Refer to chapter «Power and sensor connection (±15 VDC sensors) without optional SPS module».
- External +24 VDC supplied to POWER connector is converted into ±15 VDC by the valve internal SPS and supplied to SENSOR connector. Refer to chapter «Power and sensor connection (±15 VDC sensors) with optional SPS module».



This concept is only possible when Sensor Power Supply (SPS) option is installed.

For max load consumption, refer to chapter «Technical Data – Control and actuating unit».

Valve versions:

- 61...-... **G** .-... / 61...-... **T** .-... / 61...-... **H** .-... SPS module not included
- 61...-... **A** .-... / 61...-... **C** .-... SPS module included



The SPS module can be retrofitted.
Refer to chapter Retrofit / replacement procedure for instruction.

4.5.3.1 Power and 24V sensor connection

[61... G / 61... H versions recommended]

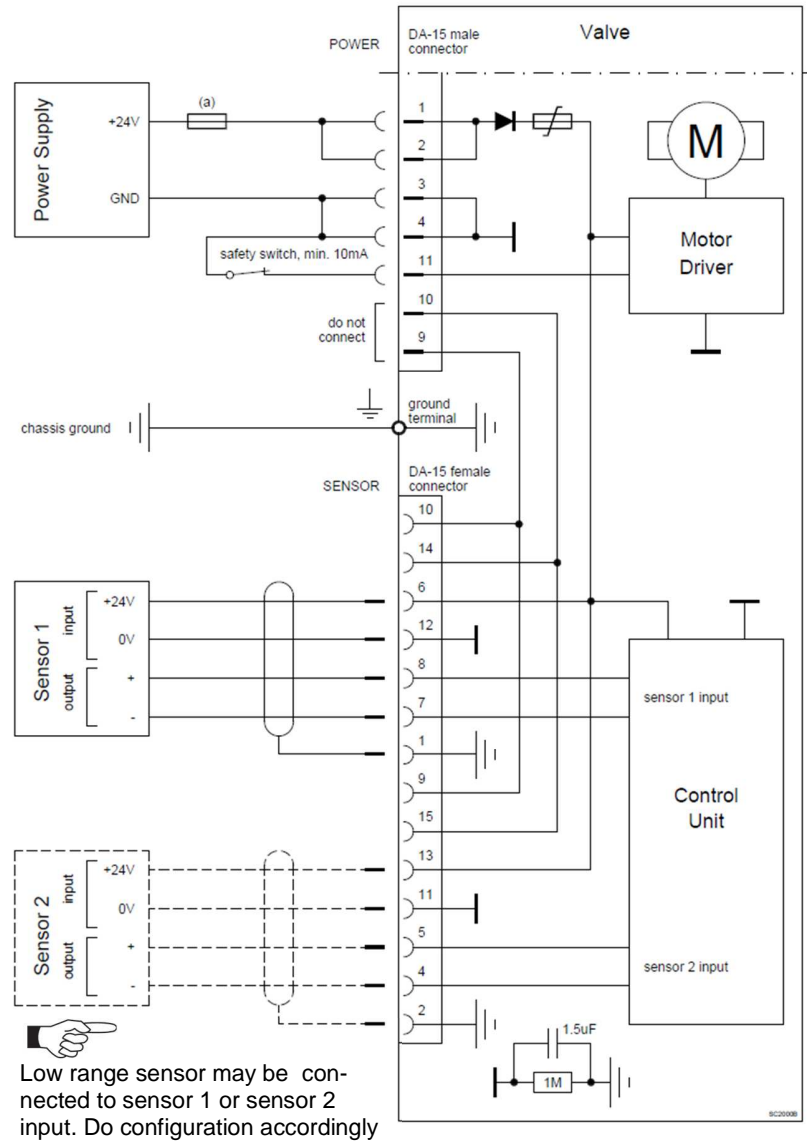

Pins 4 and 11 must be bridged for operation. An optional switch would allow for motor interlock to prevent valve from moving.

Low range sensor may be connected to sensor 1 or sensor 2 input. Do configuration accordingly



- VAT fuse recommendation: (a) 3 AF
- Use shielded sensor cable(s). Keep cable as short as possible, but locate it away from noise sources.
- Connector: Use only screws with 4–40 UNC thread for fastening the connectors!

4.5.3.2 Power and 15V sensor connection

[61.....G...../61.....H..... versions recommended]

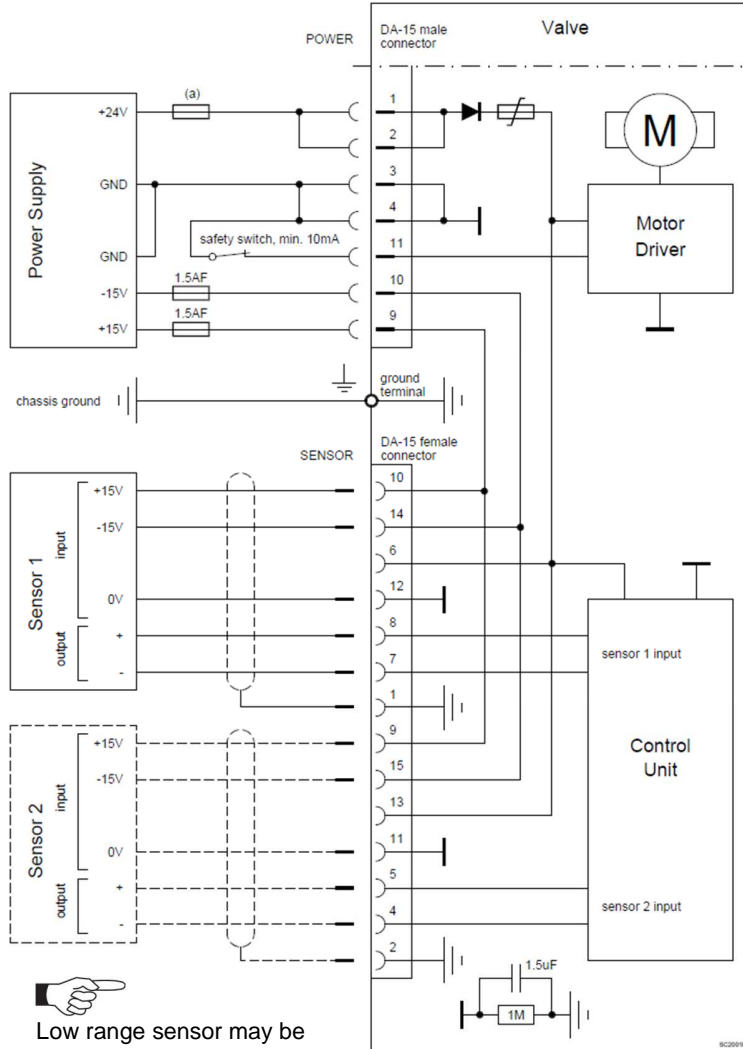

Pins 4 and 11 must be bridged for operation. An optional switch would allow for motor interlock to prevent valve from moving.

Low range sensor may be connected to sensor 1 or sensor 2 input. Do configuration accordingly.

- **VAT fuse recommendation: (a) 3 AF**
- Use shielded sensor cable(s). Keep cable as short as possible, but locate it away from noise sources.
- Connector: Use only screws with 4–40 UNC thread for fastening the connectors!

4.5.3.3 Power and 15V sensor connection with optional SPS module

[61... A... / 61... C... versions only]

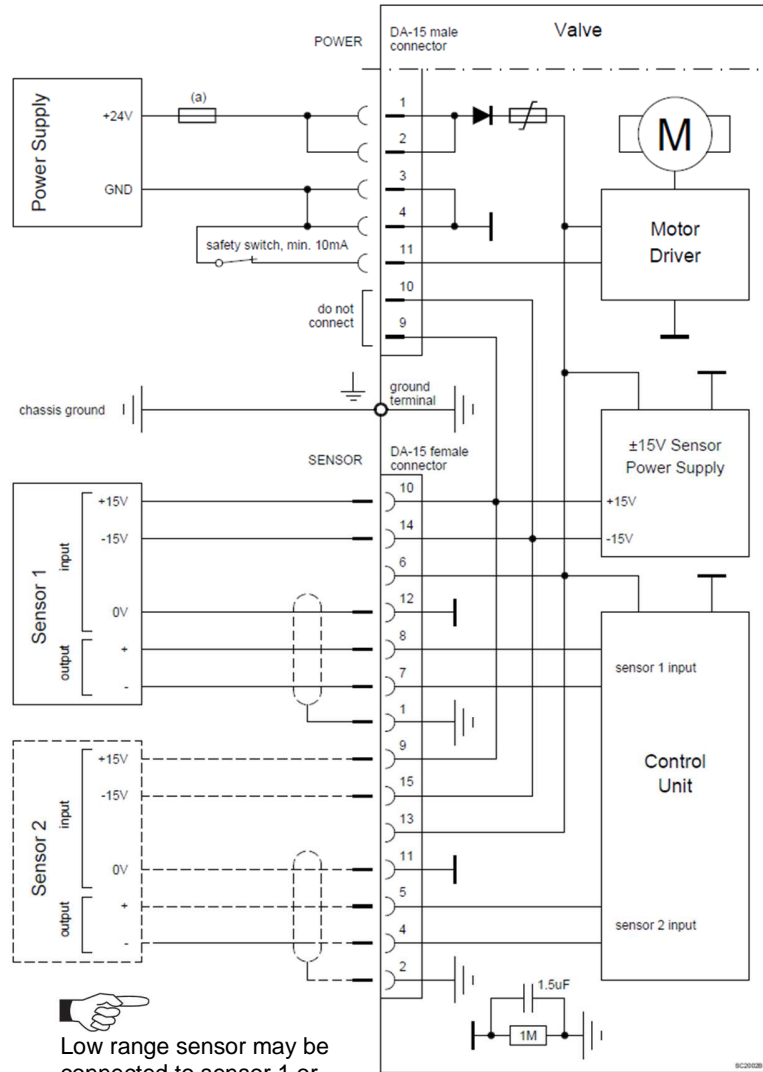

Pins 4 and 11 must be bridged for operation. An optional switch would allow for motor interlock to prevent valve from moving.

Low range sensor may be connected to sensor 1 or sensor 2 input. Do configuration accordingly.



- **VAT fuse recommendation: (a) 3 AF**
- Use shielded sensor cable(s). Keep cable as short as possible, but locate it away from noise sources.
- Connector: Use only screws with 4–40 UNC thread for fastening the connectors!

4.5.4 Drive Power Enabled Switch, Safety Mode

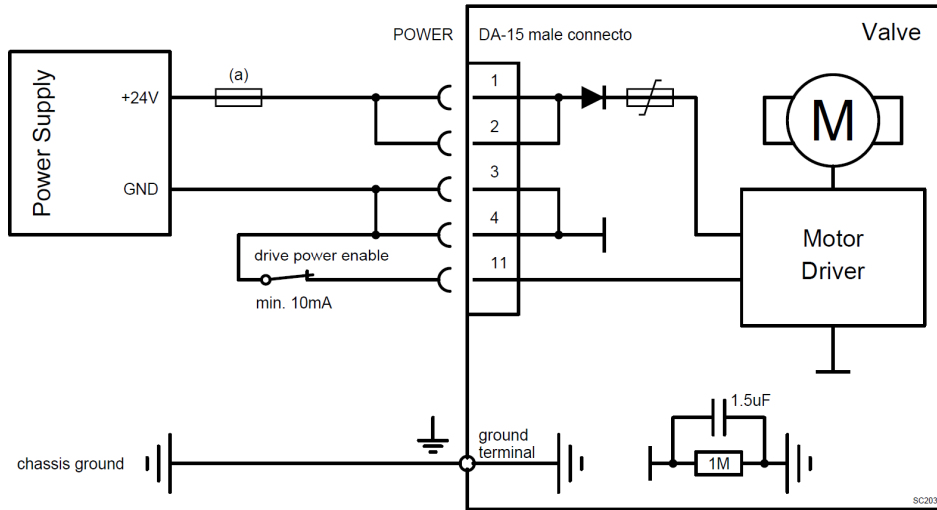

- By means of an external switch the motor power supply can be interrupted.
- In this case the valve enters the 'safety mode'.
- This motor interlock prevents the valve from moving (e.g. maintenance work).
- Data reading from the control unit remains possible.
- When motor interlock is active during power up, the valve directly enters the 'safety mode' and is not able to do homing.
- When 'safety mode' is entered from operation (i.e. pressure control mode), the unit will automatically switch to safety control mode and remain at current position. Once motor interlock is deactivated the valve go to control mode 'Init', so a homing is necessary and will carried out depending on 'Homing' setting (Refer to 'Power Up, Homing')



For safety function without human risk it is recommend using interlock function of the digital inputs, because no new homing is necessary after release of the interlock. Refer to 'Power connector IO' >> 'Digital Input'

4.6 Power Up

After power up or possibly after a reset of the valve homing is necessary to determine the plate position.

Refer to chapter «4.11.2 Homing»

4.7 Power Down, Power Failure Option

4.7.1 Power down behavior in case of power failure

Valve position before power failure:	Reaction of valve:
Closed (isolated)	Valve remains closed.
Valve open or in any intermediate position	The plate remains at the current position.



All parameters are stored in a power fail save memory.

4.7.2 Power Fail Option

Power Fail Option is circuit board that can store as much energy to close or open the valve in the event of a power failure.

Technical data

Charging Time	2 minutes max.
Durability	Up to 10 years @ 25°C ambient

These settings define what the valve is doing in case the power fails.



Valve must be equipped with the 'Power Failure Option'
[61...-...C.-... or 61...-...H.-...]

For PFO retrofit and other options refer to chapter: «Spare parts».

Location: CPA/Navigation/Parameters: Power Fail Option

Parameter	Description
Enable	'True' enables the power fail reaction. 'False' there is no reaction on a power fail
State	<i>Battery is Charging</i> <i>Ready to Use</i> <i>Active</i> <i>Failure</i>
Functionality	<i>Open</i> <i>Close</i>
Delay	In seconds After this delay, the power failure reaction starts after the power failed. Helps to bridge a short power interruption.
Battery Voltage	Shows state of charge
Power Fail Cycles	Counts Power Failure

4.8 Service Port, CPA software

The 'Service port' is designed for 'Local operation' with the software CPA - Control Performance Analyzer.

Note: Detailed help on the CPA is available in the help of the CPA itself.

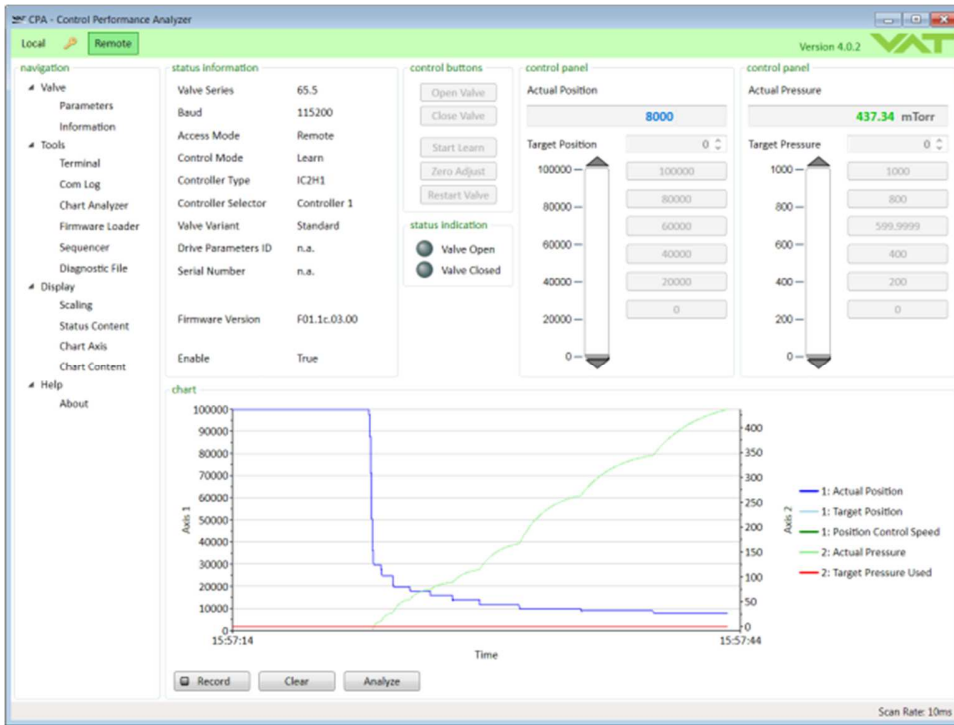

4.8.1 How to start

1. Connect service cable (USB A-B cable male-male) between PC and valve:

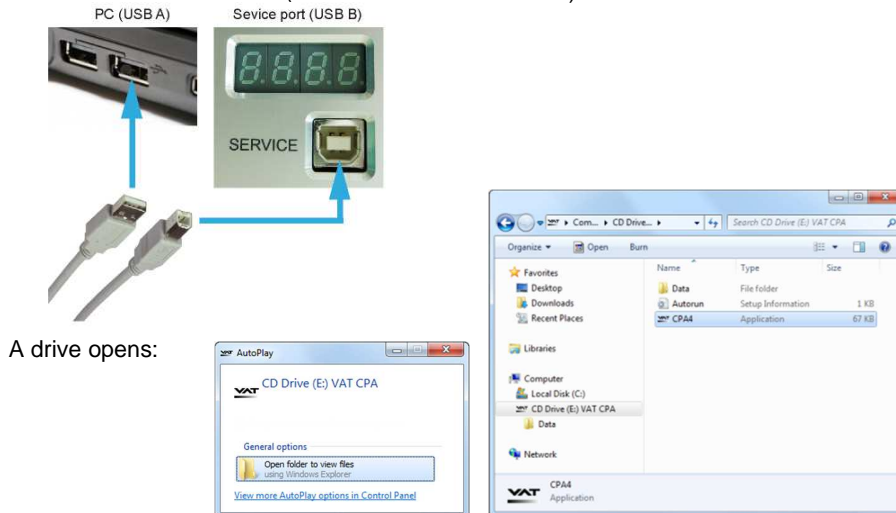

2. Double Click on 'CPA4.exe' to open the 'Control Performance Analyzer'

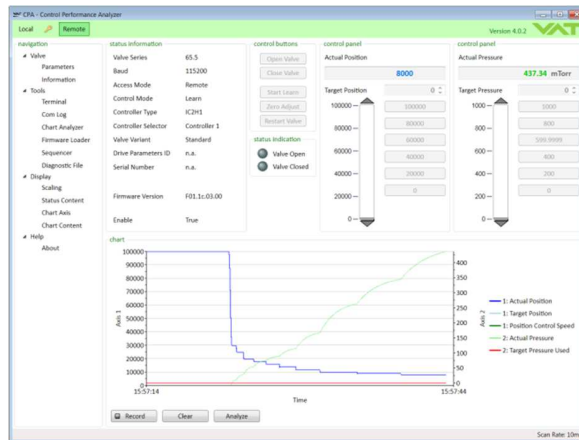

3. Click [Local] for Local operation to do configuration



When communication to service port is interrupted, the valve will change to remote operation. So when service cable will be disconnected or software will be shut down, the valve returns automatically to remote operation. This may result in an **immediate movement** of the valve depending on remote control.

4.8.2 Update

It is easy to update to the latest version of the CPA which can be found on the VAT homepage:
<https://www.vatvalve.com/downloads/software>

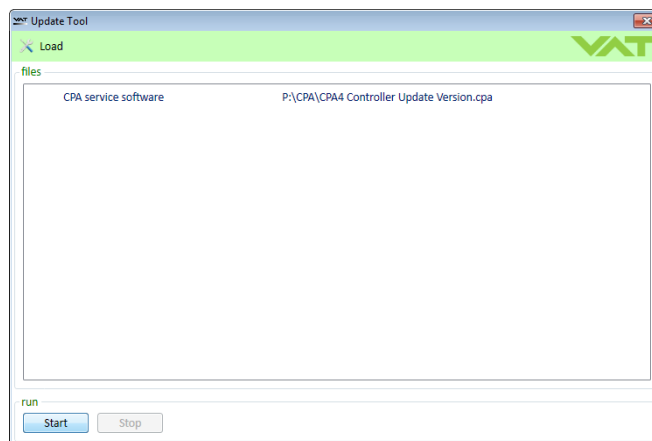

4.9 Display Information

There is a 4 digit display located on the controller. It displays configuration, status and position information. For details refer to following tables.

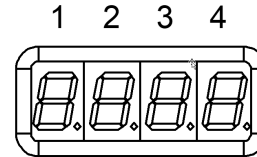

4.9.1 Power up

Description	Digit 1	Digit 2	Digit 3	Digit 4
<ul style="list-style-type: none"> 1st Power On: All dots are illuminated 	#	#	#	#
<ul style="list-style-type: none"> 2nd Valve series e.g. 67.0 		6	7	0
<ul style="list-style-type: none"> 3rd Firmware: generation.type e.g. 01.0C 	0	1	0	C
<ul style="list-style-type: none"> 4th Firmware: version.firmware e.g. 07.00 	0	7	0	0
<ul style="list-style-type: none"> 5th Controller configuration: e.g. 11.00 	Controller 1=H1 2=H2 3=H3 4=H4 5=H5 6=H6 7=H7	Interface 1=RS232/RS485 2=EtherCAT 3=DeviceNet 5=Logic 7=Profibus 8=CCLink 9=EtherNet	Options 00=none 01=SPS 02=PFO 03=Cluster 04=SPS + PFO 05=SPS + Cluster 06=PFO + Cluster 07=SPS + PFO & Cluster 08=PFO2 09=SPS + PFO2 0A=PFO2 + Cluster 0B=SPS + PFO2 + Cluster 0C=PFO3 0D=SPS + PFO3 0E=PFO3 + Cluster 0F=SPS + PFO3 + Cluster SPS Sensor Power Supply PFO Power Failure Option	
'Ho' homing is running	H	o		

4.9.2 Operation

Description / Mode	Digit 1	Digit 2	Digit 3	Digit 4
INIT (start up)	I	n.		
INIT (start up, leak tight)	I	n.		C
CLOSE	C.			
OPEN	O.			
PRESSURE control	P.			
POSITION control	A.			
INTERLOCK Valve closed or open by digital input	I.			
HOLD (position frozen)	H.			
LEARN	L.			
SAFETY Refer to «Safety mode» for details.	S.			
POWER FAILURE	F.			

C, 0...100
valve position

C = closed, leak tight
0 = minimal conductance
100 = maximum opened

4.9.3 Error

Description	Digit 1	Digit 2	Digit 3	Digit 4
Error number (xyz)	E.	x	y	z
alternately (if error code exist)				
Error code		u	v	w



For Error number / code. Refer to «Trouble shooting» for details

4.10 System Settings and States

4.10.1 Identification

4.10.1.1 Serial Number

Location: CPA/Parameters: System.Identification.Serial Number

Parameter	Description
Serial Number	VAT specific number

4.10.1.2 Configuration

Location: CPA/Parameters: System.Identification.Configuration

Parameter	Description
Valve Series	3-digit value representing the VAT valve series
Valve Variant	For some vale there exists different variants
Nominal Diameter	DN in mm. E.g DN250
Drive Parameter ID	ID of the last drive file loaded on the valve. Sets the parameters responsible for the movement characteristics of the valve
Configuration Parameters ID	ID of the last configuration file loaded on the valve. Configuration of Interface, Pressure Control, Pressure Sensor, ...

4.10.1.3 Firmware

Location: CPA/Parameters: System.Identification.Firmware

Parameter	Description
Valve Firmware ID	VAT specific identification number
Valve Firmware Version	Faa.bb.cc.dd a = Platform, Controller Type b = Type C ustomer B asis P roduction T est c = Version d = Revision
CPA Version	VAT PC software version
Interface Firmware Version	Network controller firmware
Motion Controller Firmware Version	Motion controller firmware

4.10.1.4 Hardware

Location: CPA/Parameters: System.Identification.Hardware

Parameter	Description
Controller Type	Identification of the use controller IC2H1, IC2H2, IC2H3 ...
Interface Type	RS232/RS485 EtherCAT DeviceNet Logic Profibus CCLink EtherNet
Option Type	none SPS PFO Cluster SPS & PFO SPS & Cluster PFO & Cluster SPS & PFO & Cluster SPS...Sensor Power Supply PFO...Power Failure Option

4.10.2 Statistics

Location: CPA/Parameters: System.Statistics

Parameter	Description
Start Up Counter	Each start up is counted (power on and resets) Can be used to monitor whether the valve has restarted uninvited (power loss, watchdog, ...)
Total Time Powered Up	In seconds
Time Since Power On	In seconds

4.10.3 Warning/Error

Location: CPA/Parameters: System.Warning/Error

Parameter	Description			
Warning Bitmap	Bit	Hex	Description	
	0	1	No Learn Data	
	1	2	Isolation valve does not work	
	2	4	No Sensor Active	
	3	8	PFO Not Ready	
	4	16	Cluster Slave Offline	
	6	40	Fieldbus Data Not Valid	
	8	256	Compressed Air Not Falling when valve close	
	9	512	Compressed Air Too Low	
	10	1024	Compressed Air Too High	
	12	4096	Fan stall alarm	
	Error Bitmap	Bit	Hex	Description
		0	1	Homing Position Error
1		2	Homing Not Running	
2		4	Homing Error State	
3		8	Operation Position Error	
4		10	Operation Not Running	
5		20	Operation Error State	
12		1000	Other Component	
30		40000000	General	
31		80000000	Internal	
Error Number	Refer to Error Number in Troubleshooting			
Error Code	Refer to Error Code in Troubleshooting			

4.10.4 Service

4.10.4.1 Restart, Error Recovery

Location: CPA/Parameters: System.Services

Parameter	Description
Restart Controller	Emulates a power cycle of the valve
Error Recovery	Attempts to reset the Control Mode Error without restarting the valves

4.10.4.2 Settings Handling

Location: CPA/Parameters: System.Services.Store/Restore Settings

Parameter	Description
Store User Parameters	Emulates a power cycle of the valve
Restore User Parameters	Attempts to reset the Control Mode Error without restarting the valves
Restore Factory Parameters	Protective function against changing the settings. If TRUE, the settings can no longer be changed.

Location: CPA/Parameters: System.Services.Configuration Lock

Parameter	Description
Configuration Lock Mode	Protective function against changing the settings. If TRUE, the settings can no longer be changed.

4.11 Valve Settings and States

4.11.1 States

Location: CPA/Navigation/Parameters: Valve

Parameter	Description
Actual Position	Show position of the valve plate
Position State	Intermediate Closed Open
Isolation State	Not Isolated Isolated

4.11.2 Homing

After power up or possibly after a reset of the valve homing is necessary to determine the plate position.

Location: CPA/Navigation/Parameters: Valve.Homing

Parameter	Description
Start Condition	Homing start option defines when the valve performs the homing procedure. <i>Standard</i> Automatically if valve is not in sealed state, otherwise it is waiting for a move command. <i>Open Command</i> On an open command <i>Move Command</i> On any move command <i>At Startup</i> All the time <i>Homing Command</i> On homing command <i>Move Command Without Close</i> On any move command except close command if the valve is closed
End Control Mode	This control mode is set after a successful homing. <i>Position</i> <i>Close</i> <i>Open</i> <i>Pressure Control</i>
End Position	In case the End Control Mode is set to 2 (Position), this parameter defines which position is set after successful homing.

Followed description of the **standard setting**:

Valve position before power up:	Reaction of valve:
Closed (isolated)	Valve remains closed. Homing will be done when first movement command is received.
All other than closed (not isolated)	Valve do homing to initialize position. Display shows 'Ho' until homing is done Valve position after homing is closed

4.11.3 Cycle Counter

4.11.3.1 Control Cycle

A control cycle is a complete movement of the valve, from closing to opening and back to closing, or in percentage of movement it is 200%. Each movement is added up until 200% of the movement is reached, and then the cycle counter is incremented by 1.

Location: CPA/Parameters: Valve.Position Cycle Counter

Parameter	Description
Control Cycles	The value is writable to be able to reset it
Control Cycles Total	Non-resettable value

4.11.3.2 Isolation Cycle

Counts each compression of the O-ring during the closing process (Each transition of **Isolation State** from 'Not Isolated' to 'Isolated')

Location: CPA/Parameters: Valve.Position Cycle Counter

Parameter	Description
Isolation Cycles	The value is writable to be able to reset it
Isolation Cycles Total	Non-resettable value

4.11.4 Position Restriction

This allows the position of the valve to be limited in open direction. The limitation is effective in any control mode

If restriction is active:

- **Position State** remains in Intermediate
- Digital outputs Open becomes not active

Location: CPA/Parameters: Valve.Position Restriction

Parameter	Description
Enable	Enable the restriction
Maximum Position	High position limit
Restriction Active	Indicates that the position is currently restricted by the Position Restriction.

4.11.5 Position Adaption

4.11.5.1 Usage

Chamber Matching

Adjustment of the conductance curve of different valves to obtain the same position at the same process points in different systems.

Cluster Balance

Adjusting the Position of individual valves in a valve cluster can be used to compensate certain Side-effects, e.g. keeping suction rate of downstream pump on a defined level.

4.11.5.2 Parameters

Location: CPA/Parameters: Valve.Position Adaption

Parameter	Description
Enable	Enables the adaption
Mode	Mode of the adaption. Currently only <i>Offset</i> is available.
Actual Position Mode	Selection of the position which the valve indicates <i>Real</i> <i>Adapted</i>
Offset	Amount of displacement of the position
Target Position In	Value sent via Interface or CPA Is the same as Position Control.Target Position
Target Position Used	Internal used Target Position = Target Position In + Offset
Actual Position Real	Internal real position If setting Actual Position = <i>Real</i> the valve indicates this position
Actual Position Adapted	Actual Position Real – Offset If setting Actual Position = <i>Adapted</i> the valve indicates this position

Example: shows parameter window with the offset values and behind the main window with the position values

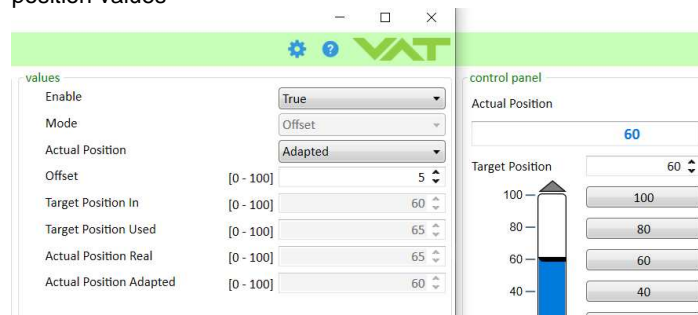

4.12 Interface EtherCAT



Neither valve display information nor CONTROL MODE values or any other fieldbus cyclic/acyclic data are related to any fieldbus states/notation

4.12.1 Connection

The EtherCAT interface is galvanic isolated from control unit.

4.12.1.1 Installation (example)

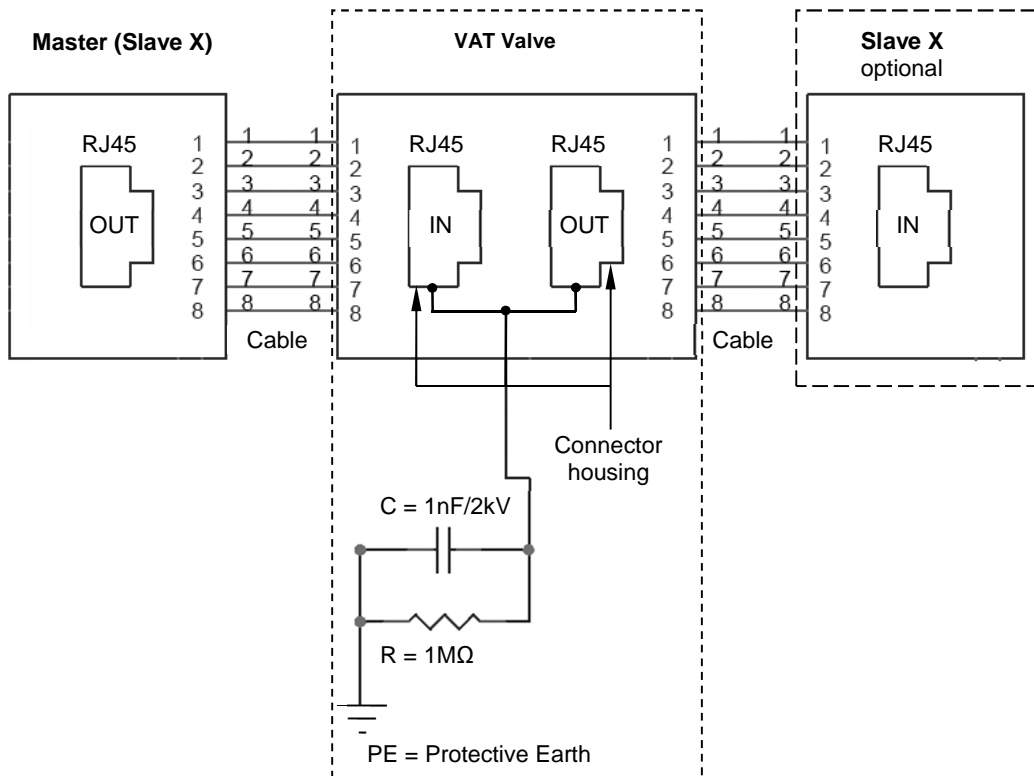

4.12.1.2 Network and cable

- **Connector type: RJ45 standard connector**
- **Cable: CAT5, 6 or 7 STP (shielded twisted pair), not crossover**



Cable length between Master and Slaves max. 100 m.

For all detail information about EtherCAT refer to EtherCAT homepage:
<http://www.ethercat.org>

4.12.2 Device identification, Rotary switches

Three hexadecimal rotary switches set the Device Identification value (ID). That means the supported address range is 0-0xFFF in hexadecimal or 0-4095 in decimal.



The Device Identification value is read once after power on.



Example: 5

4.12.3 LEDs

- ① RUN LED^{a)}
- ② Error LED^{a)}
- ③ EtherCAT (port 1) IN
- ④ EtherCAT (port 2) OUT
- ⑤ Link/Activity (port 1) IN
- ⑥ Link/Activity (port 2) OUT

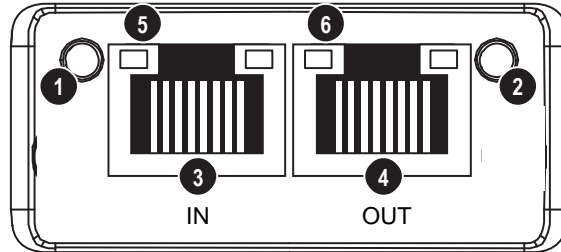

^{a)} The flash sequences for these LEDs are defined in DR303-3 (CiA)

4.12.3.1 Run LED (1)

This LED reflects the status of the CoE (CANopen over EtherCAT) communication.

LED State	Indication	Description
Off	INIT	Device in 'INIT'-state (or no power)
Green	OPERATIONAL	Device in 'OPERATIONAL'-state
Green, blinking	PRE-OPERATIONAL	Device in 'PRE-OPERATIONAL'-state
Green, single flash	SAFE-OPERATIONAL	Device in 'SAFE-OPERATIONAL'-state
Red ^{a)}	EXCEPTON state (Fatal Event)	-

^{a)} If RUN and ERR turns red, this indicates a fatal event, forcing the bus interface to a physically passive state.

4.12.3.2 Error LED (2)

This LED indicates EtherCAT communication errors etc.

LED State	Indication	Description
Off	No error	No error (or no power)
Red, blinking	Invalid configuration	State change received from master is not possible due to invalid register or object settings.
Red, single flash	Unsolicited state change	Slave device application has changed the EtherCAT state autonomously; parameter 'Change' in the AL status register is set to 01h (change/error).
Red, double flash	Application watchdog timeout	Sync manager watchdog timeout
Red ^{a)}	Application controller is not responding any more	EXCEPTION state

^{a)} If RUN and ERR turns red, this indicates a fatal event, forcing the bus interface to a physically passive state.

4.12.3.3 Link/Activity LED's (5 / 6)

These LED's indicate the EtherCAT link status and activity.

LED State	Indication	Description
Off	No link	Link not sensed (or no power)
Green	Link sensed, no activity	Link sensed, no traffic detected
Green flickering	Link sensed, no activity detected	Link sensed, traffic detected

4.12.4 Connection Loss Reaction

Connection Loss reaction defines what the valve is doing in case the EtherCAT connection get lost.

Location: CPA/Navigation/Parameters: Interface EtherCAT.Connection Loss Reaction

Parameter	Description
Enable	'True' enables the connection loss reaction, in case of 'False' there is no reaction on a connection loss
State	Current connection loss state: False Trues
Functionality	Defines the functionality in case of connection loss: Close Open

4.12.5 Position and Pressure Units

Location: CPA/Navigation/Parameters: Interface EtherCAT.Scaling

	Parameter	Description
Position Used for all position values	Position Unit	1, 10, 90, 100, 1000, 10000, user specific
	Value Closest Position	
	Value Open Position	Used if Position Unit is user specific
Pressure Used for all pressure values	Pressure Unit	Pa, kPa, bar, mbar, Torr, mTorr, psi, user specific
	Value Pressure 0	
	Value Pressure Sensor Full Scale	Used if Pressure Unit is user specific
Digital Sensor 1 Input Used for 0x2401:14	Pressure Unit	Pa, kPa, bar, mbar, Torr, mTorr, psi, user specific
	Value Pressure 0	
	Value Pressure Sensor Full Scale	Used if Pressure Unit is user specific
Digital Sensor 2 Input Used for 0x2402:14	Pressure Unit	Pa, kPa, bar, mbar, Torr, mTorr, psi, user specific
	Value Pressure 0	
	Value Pressure Sensor Full Scale	Used if Pressure Unit is user specific

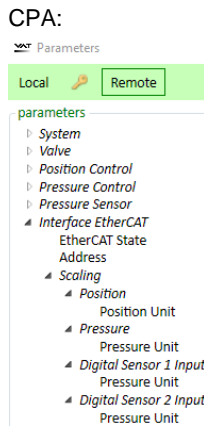

Note: The scalers for “Digital Sensor Inputs” are only visible if the sensor source is configured as ‘digital’. See chapter «Sensor configuration».

4.12.6 ESI File

The EtherCAT Slave Information (ESI) file is XML based and contains the complete description of its network accessible properties, such as process data and their mapping options, the supported mailbox protocols including optional features, as well as the supported modes of synchronization. The Network Configuration Tool uses this information for online and offline configuration of the network.

ESI files can be downloaded from www.vatvalve.com/downloads. Select the 'Software & Updates' tab and enter 'ESI' in the search field. All available ESI files will be listed. If the appropriate ESI file is not available, please contact VAT: www.vatvalve.com/contact

4.12.7 Communication failure

Failure detection with CPA	Action
Network failure: No EtherCAT communication is active	<ul style="list-style-type: none"> - Check EtherCAT cable. - Check the EtherCAT connection to master. - Check the process data output watchdog – SyncManager2 settings (see chapter: «EtherCAT configuration - 5. EtherCAT process data output watchdog – SyncManager»).



If you need any further information, please contact one of our service centers. You will find the addresses on our website: www.vatvalve.com.

4.12.8 PDO Process data objects – cyclic communication

4.12.8.1 RxPDO Output mappings

The EtherCAT process data mapping is done automatically corresponding to the following list and respectively to the sync manager information.

Mapping object	Mapping content
0x1600	SINT32 Target Pressure SINT32 Target Position SINT32 Pressure Input Digital Sensor 1 SINT32 Pressure Input Digital Sensor 2 SINT8 Control Mode UINT16 General Control Setpoint FLOAT Pressure Ramp Time
0x1601 (default)	FLOAT Target Pressure FLOAT Target Position FLOAT Pressure Input Digital Sensor 1 FLOAT Pressure Input Digital Sensor 2 SINT8 Control Mode UINT16 General Control Setpoint FLOAT Pressure Ramp Time
0x1602	SINT32 Target Pressure SINT32 Target Position SINT32 Pressure Input Digital Sensor 1 SINT32 Pressure Input Digital Sensor 2 SINT8 Control Mode UINT16 General Control Setpoint
0x1603	FLOAT Target Pressure FLOAT Target Position FLOAT Pressure Input Digital Sensor 1 FLOAT Pressure Input Digital Sensor 2 SINT8 Control Mode UINT16 General Control Setpoint
0x1604	SINT32 Target Position SINT8 Control Mode UINT16 General Control Setpoint
0x1605	FLOAT Target Position SINT8 Control Mode UINT16 General Control Setpoint
0x16FF	Configurable mapping object

Name	Byte	Range	Description
TARGET PRESSURE	4	Value in mBar Adjustable ¹⁾	Setpoint value for CONTROL MODE Pressure (5)
TARGET POSITION	4	0..100 Adjustable ¹⁾	Setpoint value for CONTROL MODE Position (2)
PRESSURE INPUT DIGITAL SENSOR 1	4	Value in mBar Adjustable ¹⁾	Pressure from digital sensor (Sensor with EtherCAT Interface)
PRESSURE INPUT DIGITAL SENSOR 2	4	Value in mBar Adjustable ¹⁾	Pressure from digital sensor (Sensor with EtherCAT Interface)
CONTROL MODE	1	2...7	1 = Homing 2 = Position control 3 = Close 4 = Open 5 = Pressure control 6 = Hold 7 = Learn
GENERAL CONTROL SETPOINT	2	-	See bitmap table below
PRESSURE RAMP TIME	1	0...10E6	Time in ms

¹⁾ To adjust range refer to chapter: «EtherCAT scaling»

GENERAL CONTROL SETPOINT bitmap table:

Bit		Description																								
0	ZERO ADJUST	Starts the zeroing of the sensors																								
1	NOT USED (reserved)	-																								
2	PING PONG TX BIT	Handshake mechanism Valve sends the inverted value of this bit in INPUT BUFFER → GENERAL STATUS → PING PONG RX BIT																								
3	NOT USED (reserved)	-																								
4	ACCESS MODE LOCKED	<p>Defines which interface, remote (EtherCAT) or service (CPA), can control the valve.</p> <table border="1"> <thead> <tr> <th>Access Mode</th> <th>Control Permission</th> <th>Comment</th> </tr> </thead> <tbody> <tr> <td>Local</td> <td>CPA</td> <td></td> </tr> <tr> <td>Remote</td> <td>EtherCAT Master</td> <td>CPA can switch to Local</td> </tr> <tr> <td>Locked</td> <td>EtherCAT Master</td> <td>CPA can't switch to Local</td> </tr> </tbody> </table> <p>If bit is set to 1 than the Access Mode = Locked If bit changes from 1 to 0 than the Access Mode changes to Remote</p> <p>Whether CPA has switched the Access Mode to Local can be seen in the Input Buffer: GENERAL STATUS → ACCESS MODE EXTENDED WARNING → REMOTE CONTROL NOT POSSIBLE</p> <p>Overview:</p> <table border="1"> <thead> <tr> <th>From</th> <th>To</th> <th>ACCESS MODE LOCKED bit</th> </tr> </thead> <tbody> <tr> <td>local or remote</td> <td>locked</td> <td>0 → 1</td> </tr> <tr> <td>locked</td> <td>remote</td> <td>1 → 0</td> </tr> <tr> <td>local</td> <td>remote</td> <td>0 → 1 → 0</td> </tr> </tbody> </table>	Access Mode	Control Permission	Comment	Local	CPA		Remote	EtherCAT Master	CPA can switch to Local	Locked	EtherCAT Master	CPA can't switch to Local	From	To	ACCESS MODE LOCKED bit	local or remote	locked	0 → 1	locked	remote	1 → 0	local	remote	0 → 1 → 0
Access Mode	Control Permission	Comment																								
Local	CPA																									
Remote	EtherCAT Master	CPA can switch to Local																								
Locked	EtherCAT Master	CPA can't switch to Local																								
From	To	ACCESS MODE LOCKED bit																								
local or remote	locked	0 → 1																								
locked	remote	1 → 0																								
local	remote	0 → 1 → 0																								
5-15	NOT USED (reserved)	-																								

4.12.8.2 TxPDO Input mappings

The EtherCAT process data mapping is done automatically corresponding to the following list and respectively to the sync manager information.

Mapping object	Mapping content	Name	Byte	Range	Description
0x1A00	SINT32	Actual Pressure	4	Value in mBar adjustable ¹⁾	ACTUAL PRESSURE
	SINT32	Pressure Sensor 1			
	SINT32	Pressure Sensor 2	4	Value in mBar adjustable ¹⁾	PRESSURE SENSOR 1
	SINT32	Actual Position			
	SINT8	Control Mode	4	Value in mBar adjustable ¹⁾	PRESSURE SENSOR 2
	UINT16	Error Number			
	UINT16	General Status			
	UINT16	General Warnings			
UINT32	Extended Warnings				
0x1A01 (default)	FLOAT	Actual Pressure	4	0...100 adjustable ¹⁾	ACTUAL POSITION
	FLOAT	Pressure Sensor 1			
	FLOAT	Pressure Sensor 2	1	0...14	Note: 0 do not mean that the valve is sealed (if sealing functionality is available). For this refer to the bit SEALING STATE in General Status . 0 = init 1 = homing 2 = position 3 = close 4 = open 5 = pressure 6 = hold 7 = learn 8 = interlock open 9 = interlock close 12 = power failure 13 = safety 14 = fatal error
	FLOAT	Actual Position			
	SINT8	Control Mode			
	UINT16	Error Number			
	UINT16	General Status			
	UINT16	General Warnings			
UINT16	General Warnings				
UINT32	Extended Warnings				
0x1A02	SINT32	Actual Position	2	200...888	ERROR NUMBER
	SINT8	Control Mode			
	UINT16	Error Number			
	UINT16	General Status			
	UINT16	General Warnings			
0x1A03	SINT32	Actual Position	2		GENERAL STATUS
	SINT8	Control Mode			
	UINT16	Error Number			
	UINT16	General Status			
	UINT16	General Warnings			
0x1AFF	Configurable mapping object	2		GENERAL WARNING	
		2		EXTENDED WARNING	

¹⁾ To adjust range refer to chapter: «Scaling of pressure and position values»

GENERAL STATUS bitmap table:

Bit		Description												
0	FIELD BUS DATA VALID	<p>0 = Valve is not in the EtherCAT state OPERATIONAL or the process data output watchdog. (SyncManager2) is disabled</p> <p>1 = Valve is in the EtherCAT state OPERATIONAL and the process data output watchdog (SyncManager2) is enabled</p>												
1	ZERO ADJUST EXECUTED	ZERO ADJUST successful executed, active for 2 seconds												
2	PING PONG RX-BIT	Handshake mechanism Is the inverted PING PONG TX-BIT from OUTPUTBUFFER → GENERAL CONTROL SETPOINT												
3	PRESSURE SIMULATION	1 = Internal pressure simulation active												
4	TARGET PRESSURE REACHED	1 = The actual pressure is within 2% of the pressure setpoint												
5-6	NOT USED (reserved)	-												
7-8	ACCESS MODE	<table border="0"> <tr> <td>bit 8</td> <td>bit 7</td> <td></td> </tr> <tr> <td>0</td> <td>0</td> <td>= LOCAL</td> </tr> <tr> <td>0</td> <td>1</td> <td>= REMOTE</td> </tr> <tr> <td>1</td> <td>0</td> <td>= LOCKED</td> </tr> </table>	bit 8	bit 7		0	0	= LOCAL	0	1	= REMOTE	1	0	= LOCKED
bit 8	bit 7													
0	0	= LOCAL												
0	1	= REMOTE												
1	0	= LOCKED												
9	WARNINGS ACTIVE	1 = At least one WARNING of the warning bitmaps is active (GENERAL WARNING bitmap and EXTENDED WARNING bitmap)												
10	SEALING STATE	1 = valve is sealed, only valid if a sealing functionality is available												
11	INTERLOCK ACTIVE	1 = an interlock input is active												
12-15	NOT USED (reserved)	-												

GENERAL WARNING bitmap table:

Bit		Description
0	NOT USED (reserved)	-
1	LEARN DATA SET	Learn data not present. Learn required for adaptive pressure control. Just active if adaptive pressure control algorithm is chosen.
2	NOT USED (reserved)	-
3	POWER FAILURE BATTERY	Not ready, voltage too low. Just active if power failure is available.
4-5	NOT USED (reserved)	-
6	FAN STALL ALARM	Just available when fan provides a stall alarm
7-15	NOT USED (reserved)	-

EXTENDED WARNING bitmap table:

Bit		Description
0	REMOTE CONTROL NOT POSSIBLE	Remote control not possible, access mode local is active, change to access mode remote or access mode locked
1	ACTUAL CONTROL MODE SETPOINT NOT ALLOWED	Not possible to switch the actual control mode to CONTROL MODE SETPOINT <ul style="list-style-type: none"> • Control mode is interlock or fatal error • CONTROL MODE SETPOINT is 5 (pressure) or 7 (learn) and no sensor is selected (sensor mode configuration)
2	ZERO DISABLED	Using zero function not possible
3	PFO DEACTIVATED	Power Failure Option is deactivated
4	NOT USED (reserved)	-
5	OUT OF RANGE: PRESSURE SETPOINT	Value of PRESSURE SETPOINT is out of range
6	OUT OF RANGE: POSITION SETPOINT	Value of POSITION SETPOINT is out of range
7-9	NOT USED (reserved)	-
10	OUT OF RANGE: CONTROL MODE SETPOINT	Value of CONTROL MODE SETPOINT is out of range
11	OUT OF RANGE: GENERAL CONTROL SETPOINT	Value of GENERAL CONTROL SETPOINT is out of range
12-15	NOT USED (reserved)	-

4.12.8.3 Ping Pong

With the Ping-pong mechanism the master can verify that the slave has read the PDO buffer content sent by the master.

Principle:

Master sets the Ping-pong bit in the object "General Control Setpoint". When the slave receives the value of "General Control Setpoint", the slave will invert this Ping-pong bit and put it into Ping-pong of "General Status"

Example:

The master wants to have a confirmation that the slave has received a new value of "Target Position":

1. Master sets "Target Position" to 123 and set Ping Pong Bit of "General Control Setpoint" to 0
2. Master waits till Ping Pong Bit of "General Status" has changed to 1 → This is the confirmation, that the PDO telegram with the new "Target Position" was received by the slave
3. Next time the master sets the Ping Pong Bit to 1. (Master changes the Ping Pong Bit every time)

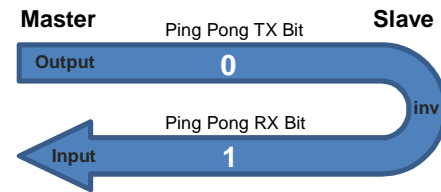

4.12.9 SDO Service data objects – acyclic communication

VAT uses for acyclic parameter data handling a standard EtherCAT mailbox transfer. The mailbox protocol is CoE (CANopen over EtherCAT), compliant to DS301 (CiA Draft Standard 301 v4.02).

4.12.9.1 List of abbreviations:

RO	Read Only
RW	Read Write
NV	Non-Volatile
V	Volatile
SI	Sub Index
Acc	Access

4.12.9.2 Standard Object Entries

Index	SI	Name	Data Type	Acc	NV	Unit	Min	Max	Description
1000		Device Type	UINT32	RO					0000 0000h (No profile)
1008		Manufacturer Device Name	Visible String	RO					
1009		Manufacturer Hardware Version	Visible String	RO					x.y.z
100A		Manufacturer Software Version	Visible String	RO					w.x.y.z w = Valve Firmware Version x = Valve Firmware Revision y = EtherCAT Stack Firmware z = Drive Firmware(s) w Format = aabcc a = Generation b = Type Customer Basis Production c = Revision Example: 01C15 Generation 01 Customer Version 15
100B		Manufacturer Bootloader Version	Visible String	RO					
1018		Identity Object	UINT8	RO					
	1	Vendor Id	UINT32	RO					0x0549 for VAT Vakuumentile AG
	2	Product Code	UINT32	RO					
	3	Revision Number	UINT32	RO					
	4	Serial Number	UINT32	RO					
1600		RxPDO Mapping Outputs Integer 1	UINT8	RO					See ESI file for content
1601		RxPDO Mapping Outputs Float 1	UINT8	RO					See ESI file for content
1602		RxPDO Mapping Outputs Integer 2	UINT8	RO					See ESI file for content
1603		RxPDO Mapping Outputs Float 2	UINT8	RO					See ESI file for content
1604		RxPDO Mapping Outputs Integer 3	UINT8	RO					See ESI file for content
1605		RxPDO Mapping Outputs Float 3	UINT8	RO					See ESI file for content

Index	SI	Name	Data Type	Acc	NV	Unit	Min	Max	Description
16FF		RxPDO Mapping Outputs User	UINT8	RO					User mapping
1A00		TxPDO Mapping Inputs Integer 1	UINT8	RO					See ESI file for content
1A01		TxPDO Mapping Inputs Float 1	UINT8	RO					See ESI file for content
1A02		TxPDO Mapping Inputs Integer 2	UINT8	RO					See ESI file for content
1A03		TxPDO Mapping Inputs Float 2	UINT8	RO					See ESI file for content
1AFF		TxPDO Mapping Inputs User	UINT8	RO					User mapping
1C00		Sync Manager Communication Type	UINT8	RO					
	1	CommunicationTypeSyncManager0	UINT8	RO					
	2	CommunicationTypeSyncManager1	UINT8	RO					
	3	CommunicationTypeSyncManager2	UINT8	RO					
	4	CommunicationTypeSyncManager3	UINT8	RO					
1C10		Sync Manager 0 PDO Assignment	UINT8	RO					
1C11		Sync Manager 1 PDO Assignment	UINT8	RO					
1C12		Sync Manager 2 PDO Assignment	UINT8	RW					
	1	Sub Index 001	UINT16	RW					
1C13		Sync Manager 3 PDO Assignment	UINT8	RW					
	1	Sub Index 001	UINT16	RW					
1C32		Sync Manager 2 Synchronization	UINT8	RO					
	1	Synchronization Type	UINT16	RO					
	2	Cycle Time	UINT32	RO					
	4	Synchronization Types Supported	UINT16	RO					
1C33		Sync Manager 3 Synchronization	UINT8	RO					
	1	Synchronization Type	UINT16	RO					
	2	Cycle Time	UINT32	RO					
	4	Synchronization Types Supported	UINT16	RO					
	20	Sync Error	BOOL	R					

4.12.9.3 Manufacturer specific object entries

Index	SI Name	Data Type	Acc	Mapping	NV	Unit	Min	Max	Def	Description
2002	Control Mode	SINT8	RW	TX/RX	V		0	14		0:Init 1:Homing 2:Position 3:Close 4:Open 5:Pressure Control 6:Hold 7:Learn 8:Interlock Open 9:Interlock Close 12:Power Failure 13:Safety 14:Error
200B	Access Mode	SINT8	RW	TX	V		0	2		0:Local 1:Remote 2:Remote Locked
2010	Identification	REC								
1	Serial Number	STRING	RO		NV					
2	Valve Series	UINT16	RO		NV		0	980		Example 655 : Series 65.5
3	Valve Variant	UINT16	RO		NV		0	100		0:Standard 1:Differential Plate 2:Face Seal 3:Aluminum 4:Stainless Steel 5:Single Drive 6:Compact 7:Fast 8:Sync 9:Direct Drive 100:Toblerone
4	Nominal Diameter	UINT16	RO		NV		20	62		20:DN10 24:DN16 28:DN25 32:DN40 34:DN50 36:DN63 38:DN80 39:DN88 40:DN100 44:DN160 46:DN200 48:DN250 50:DN320 51:DN350 52:DN400 54:DN500 56:DN630 58:DN800 60:DN1000 62:DN1250
8	Controller Type	UINT16	RO		NV		1	5		1:IC2H1 2:IC2H2 3:IC2H3 4:IC2H4 5:IC2H5 6:IC2H6 7:IC2H7
9	Interface Type	UINT16	RO		NV		1	5		1:RS232/RS485 2:EtherCAT 3:DeviceNET 4:Onboard 5:Logic
A	Option Type	UINT16	RO		NV		0	11		0:Not Available 1:SPS 2:PFO 3:Cluster 4:SPS + PFO 5:SPS + Cluster 6:PFO + Cluster 7:SPS + PFO + Cluster
C	Configuration Parameters ID	STRING	RO		NV					
D	Drive Parameters ID	STRING	RO		NV					
E	Firmware ID	STRING	RO		V					
F	Firmware Version	STRING	RO		V					
10	CPA Version	STRING	RO		V					
11	Interface Firmware Version	STRING	RO		V					
12	Motion Controller 1 Firmware Version	STRING	RO		V					
13	Motion Controller 2 Firmware Version	STRING	RO		V					



Index	SI Name	Data Type	Acc	Mapping	NV	Unit	Min	Max	Def	Description																														
2020	Statistics	REC																																						
1	Start Up Counter	UINT32	RO	TX	NV				0																															
2	Total Time Powered	UINT32	RO	TX	NV	sec			0	Stored every 15 minutes																														
3	Time Since Power On	UINT32	RO	TX	NV	sec			0																															
2030	Warning/Error	REC																																						
1	Warning Bitmap	UINT32	RO	TX	V					<table border="1"> <thead> <tr> <th>Bit</th> <th>Hex</th> <th>Description</th> </tr> </thead> <tbody> <tr><td>0</td><td>1</td><td>No Learn Data</td></tr> <tr><td>2</td><td>4</td><td>No Sensor Active</td></tr> <tr><td>3</td><td>8</td><td>PFO Not Ready</td></tr> <tr><td>6</td><td>40</td><td>Fieldbus Data Not Valid</td></tr> </tbody> </table>	Bit	Hex	Description	0	1	No Learn Data	2	4	No Sensor Active	3	8	PFO Not Ready	6	40	Fieldbus Data Not Valid															
Bit	Hex	Description																																						
0	1	No Learn Data																																						
2	4	No Sensor Active																																						
3	8	PFO Not Ready																																						
6	40	Fieldbus Data Not Valid																																						
2	Error Bitmap	UINT32	RO	TX	V					<table border="1"> <thead> <tr> <th>Bit</th> <th>Hex</th> <th>Description</th> </tr> </thead> <tbody> <tr><td>0</td><td>1</td><td>Homing Position Error</td></tr> <tr><td>1</td><td>2</td><td>Homing Not Running</td></tr> <tr><td>2</td><td>4</td><td>Homing Error State</td></tr> <tr><td>3</td><td>8</td><td>Operation Position Error</td></tr> <tr><td>4</td><td>10</td><td>Operation Not Running</td></tr> <tr><td>5</td><td>20</td><td>Operation Error State</td></tr> <tr><td>12</td><td>1000</td><td>Other Component</td></tr> <tr><td>30</td><td>40000000</td><td>General</td></tr> <tr><td>31</td><td>80000000</td><td>Internal</td></tr> </tbody> </table>	Bit	Hex	Description	0	1	Homing Position Error	1	2	Homing Not Running	2	4	Homing Error State	3	8	Operation Position Error	4	10	Operation Not Running	5	20	Operation Error State	12	1000	Other Component	30	40000000	General	31	80000000	Internal
Bit	Hex	Description																																						
0	1	Homing Position Error																																						
1	2	Homing Not Running																																						
2	4	Homing Error State																																						
3	8	Operation Position Error																																						
4	10	Operation Not Running																																						
5	20	Operation Error State																																						
12	1000	Other Component																																						
30	40000000	General																																						
31	80000000	Internal																																						
3	Error Number	UINT16	RO	TX	V					See relevant chapter																														
4	Error Code	UINT16	RO	TX	V					See relevant chapter																														
2050	Services	REC																																						
1	Restart Controller	BOOL	RW		V					Set to 1 to start the service																														
2	Store User Parameters	BOOL	RW		V																																			
3	Restore User Parameters	BOOL	RW		V																																			
5	Restore Factory Parameters	BOOL	RW		V																																			
6	Configuration Lock Mode	BOOL	RW		NV				0	Protection of settings. If active the valve does not accept set commands for parameters that are stored in non-volatile memory. 0 :not locked 1 :locked																														
7	Internal Services	UINT32	RW		V																																			
2111	Isolation State	BOOL	RO	TX	NV		0	1		0 :Not Isolated 1 :Isolated																														
2112	Position State	UINT8	RO	TX	V		0	2		Indication of valve position 0 :Intermediate 1 :Closed 2 :Open																														
2120	Homing	REC																																						

Index	SI Name	Data Type	Acc	Mapping	NV	Unit	Min	Max	Def	Description
1	Start Condition	UINT8	RW		NV		0	5	0	0: Standard Do homing after restart if valve is not in isolated state 1: Open Command, Do homing on an open command 2: Move Command, Do homing on any move command 3: At Startup, Do homing after restart 4: Homing Command, Do homing on homing command 5: Move Command Without Close Settings from move commands, without homing in close position by close command
2	Mode	UINT8	RW		NV		0	1	0	Not supported yet
3	End Control Mode	SINT8	RW		NV		2	5	2	Control Mode after homing 2: Positon 3: Close 4: Open 5: Pressure Control
4	End Position	FLOAT	RW		NV	pos*	0.0*	100.0*	0.0	Position after homing if End Control Mode is 2 (Position)
5	Status	SINT16	RO	TX	V		0	3		0: Not Started 1: In Progress 2: Completed Successfully 3: Error Occurred
2121	Position Restriction	REC								Position restriction of the valve movement.
1	Enable	BOOL	RW	TX/RX	NV		0	1	0	
3	Maximum Control Position	FLOAT	RW	TX/RX	NV	pos*	0.0*	100.0*	100.0*	With an enabled Position Restriction the valve will not move above this position
4	Restriction Active	BOOL	RO	TX/RX	V		0	1		Indicates if currently a position restriction is active
2126	Position Ramp	REC								
1	Enable	BOOL	RW		NV		0	1	0	Activate/Deactivate position target ramp.
2	Time	FLOAT	RW		NV		0	1E+7	0	
3	Slope	FLOAT	RW		NV		0	1E+8	0	
4	Mode	UINT8	RW		NV		0	1	0	0: Use Ramp Time 1: Use Ramp Slope
5	Type	UINT8	RW		NV		0	2	0	0: Linear 1: Logarithmic 2: Exponential
2130	Cycle Counter	REC								
1	Control Cycles	UINT32	RW	TX	NV				0	The valve movement is summarized. The distance open -> close -> open is 1 Control Cycle. The customer can manipulate this value.
2	Control Cycles Total	UINT32	RO	TX	NV				0	See Control Cycles. This value is the number of Control Cycles in valve lifespan.
3	Isolation Cycles	UINT32	RW	TX	NV				0	An Isolation Cycle is done if the valve has reached the isolated state. The customer can manipulate this value.
4	Isolation Cycles Total	UINT32	RO	TX	NV				0	See Isolation Cycles. This value is the number of Isolation Cycles in valve lifespan.
2160	External Isolation	REC								Only used if an external isolation valve is available
1	Follow Valve	BOOL	RW		NV		0	1	1	0: Isolation valve handled by using Target State object 1: Isolation valve automatically handled by valve. In case the valve gets close, the external isolation valve gets close too.

Index	SI Name	Data Type	Acc	Mapping	NV	Unit	Min	Max	Def	Description
2	Plate Position Isolated	FLOAT	RW		NV	pos*	0.0*	100.0*	25.0*	Only active if Follow Valve is true. Valve position when the Control Mode is set to close. To avoid a hollow space between valve and external isolation valve.
3	Target State	BOOL	RO	TX	V		0	1		If Follow Valve value is 0 than this parameter is settable. 0 : Open, external isolation valve will open 1 : Close, external isolation valve will close
4	State	BOOL	RO	TX	V		0	1		0 : Not Isolated (external isolation valve is not close) 1 : Isolated (external isolation valve is close)
5	Indicator Open	BOOL	RO	TX	V		0	1		
6	Indicator Close	BOOL	RO	TX	V		0	1		
7	Warning	BOOL	RO	TX	V		0	1	0	Set if external isolation valve is not follows on Target State . Indicator open has not expected state.
8	Isolation Cycles	UINT32	RW	TX	NV					Number of Isolation Cycles (resettable)
9	Isolation Cycles Total	UINT32	RO	TX	NV					Number of Isolation Cycles in valve lifespan.
21C0	Drive Parameter A1	REC								
21D0	Drive Parameter A2	REC								
1	Maximal Speed	FLOAT	RW		NV	r/s	0	100	***	
2	Maximal Acceleration	FLOAT	RW		NV	r/s2	0	1000	***	
3	Maximal Deceleration	FLOAT	RW		NV	r/s2	0	1000	***	
4	Jerk Limit	FLOAT	RW		NV	r/s3	0	10000	***	Value 0 means not jerk limitation
5	Home Offset	FLOAT	RW		NV	r	-100	100	***	
6	Range of Movement	FLOAT	RW		NV	r	0	10000	***	
7	Axis Only Movement Position	FLOAT	RW		NV	Range of Movement	0	1	***	S65.5 only
8	Maximum Current	FLOAT	RW		NV	Ampere	0	8	***	
9	Isolation Current	FLOAT	RW		NV	Ampere	0	8	***	
A	Drive Backlash	FLOAT	RW		NV	r	0	0.01		Drive Parameter A2 only, S65.5 only
32	Iq	FLOAT	RO	TX		Ampere				Torque producing current, vector of the two phase currents
FE	Enable Backlash Sine Subtraction	BOOL	RW		NV	r	0	1		Drive Parameter A2 only, S65.5 only
2200	Position Control	REC								
1	Actual Position	FLOAT	RO	TX	V	pos*	0.0*	100.0*		
2	Target Position	FLOAT	RW	TX/RX	V	pos*	0.0*	100.0*		
3	Position Control Speed	FLOAT	RW	TX/RX	NV		0.001	1.0	1.0	Speed valid in Control Mode = Position, 1.0 equals to full speed
2300	Pressure Control	REC								
1	Actual Pressure	FLOAT	RO	TX	V	mbar*				
2	Target Pressure	FLOAT	RW	TX/RX	V	mbar*	0.0	SFS		
3	Target Pressure Used	FLOAT	RO	TX	V	mbar*	0.0	SFS		This value is set as pressure controller input. It differs to the Target Pressure if a pressure ramp (see object 2311-2314) is used.
4	Pressure Control Speed	FLOAT	RW	TX/RX	NV		0.001	1.0	1.0	Speed valid in Control Mode = Pressure, 1.0 equals to full speed

Index	SI Name	Data Type	Acc	Mapping	NV	Unit	Min	Max	Def	Description
2310	Pressure Controller Selector	UINT8	RW	TX/RX	NV **		1	4	1	Active Controller in Control Mode = Pressure 1:Controller 1 2:Controller 2 3:Controller 3 4:Controller 4
2311	Pressure Controller 1	REC								
2312	Pressure Controller 2	REC								
2313	Pressure Controller 3	REC								
2314	Pressure Controller 4	REC								
1	Control Algorithm	UINT8	RW	TX/RX	NV **		0	2	**	0:Adaptive 1:PI 2:Soft Pump ** Controller 1 = 0, Controller 2 and 3 = 2, Controller 4 = 3
2	P-Gain	FLOAT	RW	TX/RX	NV **		0.001	100.0	0.1	Used for Control Algorithm PI and Soft Pump
3	I-Gain	FLOAT	RW	TX/RX	NV **		0.	100.0	0.1	Used for Control Algorithm PI and Soft Pump
4	Gain Factor	FLOAT	RW	TX/RX	NV **		0.0001	100.0	1.0	Used for Control Algorithm Adaptive
5	Sensor Delay	FLOAT	RW	TX/RX	NV **	sec	0.0	1.0	0.0	Used for Control Algorithm Adaptive
6	Learn Data Selection	UINT8	RW	TX/RX	NV **		0	3	0	Used for Control Algorithm Adaptive 0:Bank 1 1:Bank 2 2:Bank 3 3:Bank 4
7	Control Direction	UINT8	RW	TX/RX	NV **		0	1	**	Used for Control Algorithm PI and Soft Pump 0:Downstream 1:Upstream ** Controller 1,2 and 4 = 0, Controller 3 = 1
8	Position Filter Time	FLOAT	RW	TX/RX	NV **	sec	0	10	0.0	(advanced optimization)
A	Ramp Enable	BOOL	RW	TX/RX	NV **		0	1	1	Activate/Deactivate pressure target ramp. The effective target pressure can be read in Object 2300:03 Target Pressure Used
B	Ramp Time	FLOAT	RW	TX/RX	NV **	sec	0.0	1000000.0	1.0	Target reach time
C	Ramp Slope	FLOAT	RW	TX/RX	NV **	mbar*/sec	0.0	SFS	1.333224	Limit the rate of pressure change
D	Ramp Mode	UINT8	RW	TX/RX	NV **		0	1	0	0:Use Ramp Time 1:Use Ramp Slope
E	Ramp Start Value	UINT8	RW	TX/RX	NV **		0	1	1	0:Previous Ramp Value 1:Actual Pressure Value
F	Ramp Type	UINT8	RW	TX/RX	NV **		0	2	0	0:Linear 1:Logarithmic 2:Exponential Not supported yet

Index	SI Name	Data Type	Acc	Mapping	NV	Unit	Min	Max	Def	Description
14	P-Gain Limit	FLOAT	RW	TX/RX	NV **		0	1000	0.0	Used for Control Algorithm Adaptive (advanced optimization)
15	Flow Factor Filter Time	FLOAT	RW	TX/RX	NV **		0	10	0.4	Used for Control Algorithm Adaptive (advanced optimization)
16	Flow Factor Filter Order	UINT8	RW	TX/RX	NV **		1	6	2	Used for Control Algorithm Adaptive (advanced optimization)
2330	Store Control Parameter Volatile	BOOL	RW		NV		0	1	0	0: Store in NV Memory 1: Do Not Store in NV Memory
2331	Pressure Control Position Restriction	REC								Limit the valve movement in Control Mode Pressure
1	Enable	BOOL	RW	TX/RX	NV		0	1	0	
2	Minimum Control Position	FLOAT	RW	TX/RX	NV	pos*	0.0*	100.0*	0.0*	
3	Maximum Control Position	FLOAT	RW	TX/RX	NV	pos*	0.0*	100.0*	100.0*	
2333	Automated Controller Selector	REC								
1	Enable	BOOL	RW	TX/RX	NV		0	1	0	
2	Mode	UINT8	RW	TX/RX	NV		0	1	0	Defines how the Controller is selected 0: Threshold 1: Pressure Direction
3	Controller Selector Bitmap	UINT8	RW	TX/RX	NV		0	15	15	Used if Mode = 0 Threshold Determines which controller/threshold will participate in the automated selection
4	Controller 1 Threshold	FLOAT	RW	TX/RX	NV	mbar*	0.0	1000	0	Used if Mode = 0 Threshold Upper pressure limit for Controller 1 selection
5	Controller 2 Threshold	FLOAT	RW	TX/RX	NV	mbar*	0.0	1000	0	Used if Mode = 0 Threshold Upper pressure limit for Controller 2 selection
6	Controller 3 Threshold	FLOAT	RW	TX/RX	NV	mbar*	0.0	1000	0	Used if Mode = 0 Threshold Upper pressure limit for Controller 3 selection
7	Controller 4 Threshold	FLOAT	RW	TX/RX	NV	mbar*	0.0	1000	0	Used if Mode = 0 Threshold Upper pressure limit for Controller 4 selection
8	Threshold Condition	UINT8	RW	TX/RX	NV		0	0	0	Used if Mode = 0 Threshold 0: Lower or equal 1: Equal
9	Controller Pressure Rising	UINT8	RW	TX/RX	NV		0	3	0	Used if Mode = 1 Pressure Direction Select Controller which is use for up control 0: Controller 1 1: Controller 2 2: Controller 3 3: Controller 4
A	Controller Pressure Falling	UINT8	RW	TX/RX	NV		0	3	0	Used if Mode = 1 Pressure Direction Select Controller which is use for down control 0: Controller 1 1: Controller 2 2: Controller 3 3: Controller 4
2334	Profile Ramp	REC								Defines pressure depending target pressure ramp (soft pump, soft vent curve)
1	Enable	BOOL	RW	TX/RX	NV		0	1	0	

Index	SI Name	Data Type	Acc	Mapping	NV	Unit	Min	Max	Def	Description
2	Threshold Mode	UINT8	RW	TX/RX	NV		0	1	0	Defines which pressure the threshold refers to 0: Actual Pressure 1: Target Pressure Used
3	Ramp Type	UINT8	RW	TX/RX	NV		0	2	0	0: Linear 1: Logarithmic 2: Exponential
4	Actual Slope	FLOAT	RO	RX	V	mbar*/sec	0.0	1000000.0	0	
5	Segment Selector Bitmap	UINT16	RW	TX/RX	NV		0	1023	0	Defines which segment is used for the Profile Ramp
6	Controller Selector Bitmap	UINT8	RW	TX/RX	NV		0	15	0	Determines which Controller 2311,2312,2313,2314 uses the profile ramp
7	Segment 1 Threshold	FLOAT	RW	TX/RX	NV	mbar*	0.0	1000000.0	0	Upper pressure limit of pressure segment 1
8	Segment 1 Slope	FLOAT	RW	TX/RX	NV	mbar*/sec	0.0	1000000.0	0	Ramp slope in the segment 1
9	Segment 2 Threshold	FLOAT	RW	TX/RX	NV	mbar*	0.0	1000000.0	0	Upper pressure limit of pressure segment 2
A	Segment 2 Slope	FLOAT	RW	TX/RX	NV	mbar*/sec	0.0	1000000.0	0	Ramp slope in the segment 2
B	Segment 3 Threshold	FLOAT	RW	TX/RX	NV	mbar*	0.0	1000000.0	0	Upper pressure limit of pressure segment 3
C	Segment 3 Slope	FLOAT	RW	TX/RX	NV	mbar*/sec	0.0	1000000.0	0	Ramp slope in the segment 3
D	Segment 4 Threshold	FLOAT	RW	TX/RX	NV	mbar*	0.0	1000000.0	0	Upper pressure limit of pressure segment 4
E	Segment 4 Slope	FLOAT	RW	TX/RX	NV	mbar*/sec	0.0	1000000.0	0	Ramp slope in the segment 4
F	Segment 5 Threshold	FLOAT	RW	TX/RX	NV	mbar*	0.0	1000000.0	0	Upper pressure limit of pressure segment 5
10	Segment 5 Slope	FLOAT	RW	TX/RX	NV	mbar*/sec	0.0	1000000.0	0	Ramp slope in the segment 5
11	Segment 6 Threshold	FLOAT	RW	TX/RX	NV	mbar*	0.0	1000000.0	0	Upper pressure limit of pressure segment 6
12	Segment 6 Slope	FLOAT	RW	TX/RX	NV	mbar*/sec	0.0	1000000.0	0	Ramp slope in the segment 6
13	Segment 7 Threshold	FLOAT	RW	TX/RX	NV	mbar*	0.0	1000000.0	0	Upper pressure limit of pressure segment 7
14	Segment 7 Slope	FLOAT	RW	TX/RX	NV	mbar*/sec	0.0	1000000.0	0	Ramp slope in the segment 7
15	Segment 8 Threshold	FLOAT	RW	TX/RX	NV	mbar*	0.0	1000000.0	0	Upper pressure limit of pressure segment 8
16	Segment 8 Slope	FLOAT	RW	TX/RX	NV	mbar*/sec	0.0	1000000.0	0	Ramp slope in the segment 8
17	Segment 9 Threshold	FLOAT	RW	TX/RX	NV	mbar*	0.0	1000000.0	0	Upper pressure limit of pressure segment 9
18	Segment 9 Slope	FLOAT	RW	TX/RX	NV	mbar*/sec	0.0	1000000.0	0	Ramp slope in the segment 9
19	Segment 10 Threshold	FLOAT	RW	TX/RX	NV	mbar*	0.0	1000000.0	0	Upper pressure limit of pressure segment 10
1A	Segment 10 Slope	FLOAT	RW	TX/RX	NV	mbar*/sec	0.0	1000000.0	0	Ramp slope in the segment 10



Index	SI Name	Data Type	Acc	Mapping	NV	Unit	Min	Max	Def	Description
2350	Adaptive Learn	REC								
2	Type	SINT8	RW		NV		0	0	0	0:Standard
3	Bank Selection	SINT8	RW		NV		0	3	0	Select a learn bank to save the data for the following learn procedure 0:Bank 1 1:Bank 2 2:Bank 3 3:Bank 4
4	Pressure Limit [SFS]	FLOAT	RW	TX/RX	NV	SFS	0.01	1.2	1.0	Learn procedure will be executed to the Pressure Limit
5	Open Speed	FLOAT	RW		NV		0.001	1.0	1.0	1.0 equals to full speed
6	Status	SINT8	RO	TX	V		0	4		0:Not Started 1:In Progress 2:Completed Successfully 3:Aborted 4:Failed
7	Warning Info	UINT16	RO	TX	V					Bit 0: Learn is running Bit 1: Checksum error (learn data corrupt) Bit 2: Learn procedure terminated by user Bit 3: Pressure at position open > 50% of pressure limit Bit 4: Pressure at minimal conductance position < 10 % of pressure limit Bit 5: Pressure falls while move valve in direction of close Bit 6: Pressure at open position does not match pressure of previous open Bit 7: Learn procedure terminated by program Bit 8: Pressure <= 0 at open position (no gas flow set?)
8	Delete All Learn Bank Data	BOOL	RW		V		0	1		Set to 1 delete all learn bank data.
9	Pressure Limit	FLOAT	RW		NV	mbar*				See Pressure Limit [SFS] above, same functionality but user pressure scaling is used
2351	Adaptive Learn Position Table	ARRAY								
1	Sub Index 1	FLOAT	RW		NV	pos*	0.0	1.0		0.0:minimum position 1.0:open position -1.0:not used element
⋮	⋮									
3C	Sub Index 60									
2360	Adaptive Learn Bank 1	REC								
2370	Adaptive Learn Bank 2	REC								
2380	Adaptive Learn Bank 3	REC								
2390	Adaptive Learn Bank 4	REC								
01	Status	SINT8	RO		NV		0	2	0	0:Not used 1:Available 2:Available with Warnings
02	Warning Info	UINT16	RO		NV				0	
03	Type	SINT8	RO		NV		0	0	0	0:Standard
04	Delete Learn Bank Data	BOOL	RW		V					Set to 1 delete learn bank data.
2361	Learn Bank 1 Data	ARRAY								
2371	Learn Bank 2 Data	ARRAY								
2381	Learn Bank 3 Data	ARRAY								
2391	Learn Bank 4 Data	ARRAY								

Index	SI Name	Data Type	Acc	Mapping	NV	Unit	Min	Max	Def	Description
1	<i>Sub Index 1</i>	UINT32	RW		NV					To copy learn data copy this content to another bank (or valve)
7C <i>Sub Index 124</i>										
2362	<i>Learn Bank 1 Position Table</i>	ARRAY								
2372	<i>Learn Bank 2 Position Table</i>	ARRAY								
2382	<i>Learn Bank 3 Position Table</i>	ARRAY								
2392	<i>Learn Bank 4 Position Table</i>	ARRAY								
1	<i>Sub Index 1</i>	FLOAT	RO		NV	pos*	0.0*	100.0*		
3C <i>Sub Index 60</i>										
2363	<i>Learn Bank 1 Pressure Table</i>									
2373	<i>Learn Bank 2 Pressure Table</i>									
2383	<i>Learn Bank 3 Pressure Table</i>									
2393	<i>Learn Bank 4 Pressure Table</i>									
1	<i>Sub Index 1</i>	FLOAT	RO		NV	mbar*				
3C <i>Sub Index 60</i>										
2400	<i>Sensor Zero Adjust</i>	REC								
1	<i>Sensor Selection</i>	SINT8	RW	TX/RX	V		0	2		0:Sensor 1 + 2 1:Sensor 1 2:Sensor 2
2	<i>Target Pressure</i>	FLOAT	RW	TX/RX	V	mbar*				This value is typically the value 0.0 when the chamber is fully pumped down. However, it could also be the value of another pressure.
3	<i>Execute</i>	SINT8	RW	TX/RX	V		1	2		Write to this object to execute a Zero Adjust or to clear the Zero Adjust offset value. The calculated offset value can read in Sensor 1 Zero Adjust Offset Value [SFS] or Sensor 2 Zero Adjust Offset Value [SFS]. Be sure that Zero Adjust Enable (Zero Adjust Enable Sensor 1 and Sensor 2) is 1, in other case the executed Zero Adjust has no effect on the Actual Pressure value 1:Execute Zero Adjust 2:Clear Offset Value
2401	<i>Sensor 1</i>	REC								
2402	<i>Sensor 2</i>	REC								
1	<i>Available</i>	BOOL	RW		NV		0	1	1	Is a sensor available? (Set Available = 1 if a digital sensor or the pressure simulation is used)
2	<i>Enable</i>	BOOL	RW		NV		0	1	1	0:Not used for pressure control, object Pressure Sensor 1 can be used for monitoring 1:Used for pressure control (to build Actual Pressure value)
3	<i>Data Unit</i>	SINT8	RW		NV		0	7	4	0:Pa 3:mbar 6:psia 1:kPa 4:Torr 7:psig 2:bar 5:mTorr
4	<i>Upper Limit Data Value</i>	FLOAT	RW		NV	refers to 2401:03			1.0	
5	<i>Lower Limit Data Value</i>	FLOAT	RW		NV	refers to 2401:03			0.0	
6	<i>Upper Limit Voltage Value</i>	FLOAT	RW		NV	volt			10.0	
7	<i>Lower Limit Voltage Value</i>	FLOAT	RW		NV	volt			0.0	

Index	SI Name	Data Type	Acc	Mapping	NV	Unit	Min	Max	Def	Description
8	Scale	SINT8	RW		NV		0	1	0	0:Linear 1:Logarithmic (not supported yet)
9	Voltage Per Decade	FLOAT	RW		NV	volt			0.0	
A	Zero Adjust Enable	BOOL	RW		NV		0	1	1	
B	Zero Adjust Offset Value [SFS]	FLOAT	RW		NV	SFS			0.0	Value 1.0 means sensor full scale. For example for a 0-10 Volt gauge the value 0.1 means 1 Volt
F	Filter Enable	BOOL	RW		NV		0	1	0	
10	Filter Time	FLOAT	RW		NV	sec	0.0	1.0	0.0	
12	Input Source	SINT8	RW		NV		0	2	0	0:Analog 1:Digital 2:Simulation
14	Pressure Input Digital Sensor	FLOAT	RW	TX/RX	V	mbar*				Only used if Input Source = Digital. In this case the actual sensor pressure value is send by the customer via EtherCAT.
18	Pressure Sensor	FLOAT	RO	TX	V	mbar*				Pressure value for sensor
2405	Sensor Crossover	REC								
1	Crossover Mode	SINT8	RW		NV		0	1	0	0: Soft Switch Actual Pressure is a summation of the pressure value of sensor 1 pressure and sensor 2 1: Hard Switch Actual Pressure is the value of sensor 1 or sensor 2 2: Target Pressure If Target Pressure falls into low range sensor, the low sensor is used for Actual Pressure . In other case the high range sensor is used.
2	Threshold High [SFS low sensor]	FLOAT	RW		NV	SFS of low sensor	0.0	1.0	1	Defines the crossover area.
3	Threshold Low [SFS low sensor]	FLOAT	RW		NV	SFS of low sensor	0.0	1.0	0.95	Example: Threshold High = 1.0 [SFS of low sensor] Threshold Low = 0.9 [SFS of low sensor] <u>Soft switch:</u> At pressure <= 0.9*SFS (low sensor): Actual Pressure = Sensor low pressure At pressure 0.95*SFS (low sensor): Actual Pressure = 50% * Sensor low pressure + 50% sensor high pressure At pressure >= 1.0*SFS (low sensor): Actual Pressure = Sensor high pressure <u>Hard switch:</u> At pressure increase over 1.0*SFS (low sensor): Actual Pressure = Sensor high pressure after Delay At pressure decrease under 0.9*SFS (low sensor): Actual Pressure = Sensor low pressure after Delay
4	Delay	FLOAT	RW		NV		0.0	10.0	0	Only relevant in Crossover Mode = Hard Switch
2601	Interface EtherCAT	REC								
1	EtherCAT State	UINT8	RO	TX	V		1	8		1:Init 2:Pre-OP 3:Bootstrap 4:Safe-Op 8:Op

<i>Index</i>	<i>SI Name</i>	<i>Data Type</i>	<i>Acc</i>	<i>Mapping</i>	<i>NV</i>	<i>Unit</i>	<i>Min</i>	<i>Max</i>	<i>Def</i>	<i>Description</i>
2	Address	UINT16	RO	TX	V		0	4095		Defined by the address switches on the valve controller
3	Connection Loss Reaction Enable	BOOL	RW		NV		0	1	1	
4	Connection Loss Reaction Functionality	SINT8	RW		NV		0	1	1	0: Open 1: Close

Index	SI Name	Data Type	Acc	Mapping	NV	Unit	Min	Max	Def	Description
2610	Scaling	REC								
1	Position Unit	SINT16	RW		NV		0	7	3	0: 0 - 1 1: 0 - 10 2: 0 - 90 3: 0 - 100 4: 0 - 1000 5: 0 - 10000 6: 0 - 100000 7: User specific User specific (Range is defined by Value Closest Position and Value Open Position)
2	Value Closest Position	FLOAT	RW		NV				0.0	Only used if Position Unit is set to User Specific. Defines the value for the closest position.
3	Value Open Position	FLOAT	RW		NV				1.0	Only used if Position Unit is set to User Specific. Defines the value for the open position.
5	Pressure Unit	SINT16	RW		NV		0	7	3	0: Pa 1: kPa 2: Bar 3: mBar 4: Torr 5: mTorr 6: Psi 7: User specific Range is defined by Value Pressure 0 and Value Pressure Sensor Full Scale
6	Value Pressure 0	FLOAT	RW		NV				0.0	Only used if Pressure Unit is set to User specific. Defines the value for pressure 0.
7	Value Pressure Sensor Full Scale	FLOAT	RW		NV				1.0	Only used if Pressure Unit is set to User specific. Defines the value for actual sensor full scale.
9	Digital Sensor 1 Input Pressure Unit	SINT16	RW		NV		0	7	5	0: Pa 1: kPa 2: Bar 3: mBar 4: Torr 5: mTorr 6: psi 7: User specific Range is defined by Value Pressure 0 and Value Pressure Sensor Full Scale
A	Value Sensor 1 Lower Limit Data Value	FLOAT	RW		NV				0.0	Only used if Pressure Unit is set to User specific. Defines the value for the pressure value 2401:05 (Sensor1.Lower Limit Data Value)
B	Value Sensor 1 Upper Limit Data Value	FLOAT	RW		NV				1.0	Only used if Pressure Unit is set to User specific. Defines the value for the pressure value 2401:04 (Sensor1.Upper Limit Data Value)

Index	SI Name	Data Type	Acc	Mapping	NV	Unit	Min	Max	Def	Description
D	Digital Sensor 2 Input Pressure Unit	SINT16	RW		NV		0	7	5	0: Pa 1: kPa 2: Bar 3: mBar 4: Torr 5: mTorr 6: psi 7: User specific Range is defined by Value Pressure 0 and Value Pressure Sensor Full Scale
E	Value Sensor 2 Lower Limit Data Value	FLOAT	RW		NV				0.0	Only used if Pressure Unit is set to User specific. Defines the value for the pressure value 2402:05 (Sensor2.Lower Limit Data Value)
F	Value Sensor 2 Upper Limit Data Value	FLOAT	RW		NV				1.0	Only used if Pressure Unit is set to User specific. Defines the value for the pressure value 2402:04 (Sensor2.Upper Limit Data Value)
2C01	Power Connector IO Digital Input 1	REC								Logic Inputs available on the valve power connector
2C02	Power Connector IO Digital Input 2	REC								Logic Inputs available on the valve power connector
1	Enable	BOOL	RW		NV		0	1	1	
2	State	BOOL	RO	TX	V		0	1		0:Signal level low 1:Signal level high
3	Functionality	SINT8	RW		NV		0	1	0	0:Interlock Open 1:Interlock Close
4	Inverted	BOOL	RW		NV		0	1	0	
2C03	Power Connector IO Digital Output 1	REC								Logic Outputs available on the valve power connector
2C04	Power Connector IO Digital Output 2	REC								Logic Outputs available on the valve power connector
1	Enable	BOOL	RW		NV		0	1	1	
2	State	BOOL	RO	TX	V		0	1		0:Signal level low 1:Signal level high
3	Functionality	SINT8	RW		NV		0	1	0	0:Open 1:Close
4	Inverted	BOOL	RW		NV		0	1	0	
2E00	Power Fail Option	REC								Only valid if a Power Fail Option is available
1	Enable	BOOL	RW		NV				1	
2	State	SINT8	RO	TX	V		0	3		0:Battery is Charging 1:Ready to Use 2:Active 3:Failure
3	Functionality	SINT8	RW		NV		0	1	1	0:Open 1:Close
4	Delay	FLOAT	RW		NV	sec	0.0	2.0	0.5	
5	Battery Voltage	FLOAT	RO		V	volt				
6	Power Fail Cycles	UINT16	RW	TX	NV					



Index	SI Name	Data Type	Acc	Mapping	NV	Unit	Min	Max	Def	Description	
2F00	VAT Profile Objects	REC									
1	Target Pressure	SINT32	RW	TX/RX	V	mbar*	0.0	SFS			
2	Target Position	SINT32	RW	TX/RX	V	pos*	0.0*	100.0*			
3	Pressure Input Digital Sensor 1	SINT32	RW	TX/RX	V	mbar*					
4	Pressure Input Digital Sensor 2	SINT32	RW	TX/RX	V	mbar*					
5	Control Mode Setpoint (possibly not available)	UINT8	RW	TX/RX	V		1	7	1: Homing 2: Position 3: Close	4: Open 5: Pressure 6: Hold 7: Learn	
6	General Control Setpoint	UINT16	RW	TX/RX	V		0	31	Bit 0: Zero Bit 1: Not used Bit 2: Ping Pong TX Bit	Bit 3: Not Used Bit 4: Access Mode Locked Bit 5-15: Not Used	
7	Pressure Ramp Time	FLOAT	RW	TX/RX	NV **	sec	0.0	1000000.0	1.0		
8	Actual Pressure	SINT32	RO	TX	V	mbar*					
9	Pressure Sensor 1	SINT32	RO	TX	V	mbar*					
A	Pressure Sensor 2	SINT32	RO	TX	V	mbar*					
B	Actual Position	SINT32	RO	TX	V	pos*	0.0*	100.0*			
C	Control Mode (possibly not available)	UINT8	RO	TX	V		0	14	0: Init 1: Homing 2: Position 3: Close 4: Open	5: Pressure Control 6: Hold 7: Learn 8: Interlock Open 9: Interlock Close 12: Power Failure 13: Safety 14: Error	
D	General Status	UINT16	RO	TX	V		0	4095	Bit 0: Fieldbus data valid Bit 1: Zero executed Bit 2: Ping pong RX-Bit Bit 3: Pressure simulation	Bit 4: Target pressure reached Bit 5-6: Not used Bit 7-8: Access Mode	Bit 9: Warnings active Bit 10: Sealing state Bit 11: Interlock active Bit 12-15: Not used
E	General Warnings	UINT16	RO	TX	V		0	15	Bit 0: Not used Bit 1: Learn data set	Bit 2: Not used Bit 3: Power Failure Battery	Bit 4-15: Not used
F	Extended Warnings	UINT16	RO	TX	V		0	4095	Bit 0: Remote Control not possible Bit 1: Actual Control Mode Setpoint not allowed Bit 2: Zero disabled Bit 3: PFO deactivated	Bit 4: Not Used Bit 5: Out Of Range: Pressure Setpoint Bit 6: Out Of Range: Position Setpoint Bit 7-9 Not Used	Bit 10: Out Of Range: Control Mode Setpoint Bit 11: Out Of Range: General Control Setpoint Bit 12-15: Not Used

* Scaling:

Position:

Use object **Scaling 2610h** (SI 01h, 02h and 03h) to adjust the value range of all position objects

Note: In case of an isolation functionality is available the minimum position does not mean the isolation state

Pressure:

Use object **Scaling 2610h** (SI 05h, 06h and 07h) to adjust the value range of all pressure objects

Digital Pressure Sensor 1:

Use object **Scaling 2610h** (SI 09h, 0Ah and 0Bh) to adjust the value range of object Pressure Input Digital Sensor 1

Digital Pressure Sensor 2:

Use object **Scaling 2610h** (SI 0Dh, 0Eh and 0Fh) to adjust the value range of object Pressure Input Digital Sensor 2

** In case of **Store Control Parameter Volatile (2330h)** is 1 (true) the value will not be stored in nonvolatile memory.

*** Valve series specific

4.12.9.4 Manufacturer specific IC compatible object entries

Index	SI	Name	Data Type	Acc	Mapping	NV	Unit	Min	Max	Def	Description
20E6		Sensor operation mode	UINT8	RW	RT	NV		0	10	1	0:no sensor 1:sensor 1 3:sensor 2 2:sensor 1 high, sensor 2 low, Crossover Mode Soft Switch 4:sensor 2 high, sensor 1 low, Crossover Mode Soft Switch 7:sensor 1 high, sensor 2 low, Crossover Mode Target Pressure 8:sensor 2 high, sensor 1 low, Crossover Mode Target Pressure 9:sensor 1 high, sensor 2 low, Crossover Mode Hard Switch 10:sensor 2 high, sensor 1 low, Crossover Mode Hard Switch
20E7		Sensor full scale ration	FLOAT	RW		NV		1.0	1000.0	10.0	Full scale ratio between high sensor and low sensor
2118		Maximum learn pressure	UINT16	RW	TX/RX	V		0	1000	1000	Max. learn pressure in ‰ of SFS
2119		Learn state	UINT16	RO	TX	V					See table below
2190		Valve speed	UINT16	RW	TX/RX	NV		0	1000	1000	Valve speed during position and pressure control
2199		Pressure Control Algorithm	UINT8	RW	TX/RX	NV		0	3	0	0 = adaptive downstream (default) 1 = Fixed 1 2 = Fixed 2 3 = soft pump Refer to chapter: «Pressure control configuration»
219A		Sensor delay (adaptive downstream)	FLOAT	RW	TX/RX		sec	0.0	1.0	0.0	
219B		Ramp time (adaptive downstream)	FLOAT	RW	TX/RX		sec	0.0	1'000'000.0	0.0	
219C		Ramp mode (adaptive downstream)	UINT8	RW	TX/RX			0	1	0	0 = Constant Time 1 = Constant Slope
219E		Gain factor (adaptive downstream)	FLOAT	RW	TX/RX			0.0001	7.5	1.0	
21A5		Ramp time (fixed 1)	FLOAT	RW	TX/RX		sec	0.0	1'000'000.0	0.0	
21A6		Ramp mode (fixed 1)	UINT8	RW	TX/RX			0	1	0	0 = Constant Time 1 = Constant Slope
21A7		Control direction (fixed 1)	UINT8	RW	TX/RX			0	1	0	0 = downstream 1 = upstream
21A8		P-Gain (fixed 1)	FLOAT	RW	TX/RX			0.001	100	0.1	
21A9		I-Gain (fixed 1)	FLOAT	RW	TX/RX			0.0	100.0	0.1	
21AF		Ramp time (fixed 2)	FLOAT	RW	TX/RX		sec	0.0	1'000'000.0	0.0	
21B0		Ramp mode (fixed 2)	UINT8	RW	TX/RX			0	1	0	0 = Constant Time 1 = Constant Slope
21B1		Control direction (fixed 2)	UINT8	RW	TX/RX			0	1	0	0 = Downstream 1:Upstream
21B2		P-Gain (fixed 2)	FLOAT	RW	TX/RX			0.001	100	0.1	
21B3		I-Gain (fixed 2)	FLOAT	RW	TX/RX			0.0	100.0	0.1	
21B9		Ramp time (soft pump)	FLOAT	RW	TX/RX		sec	0.0	1'000'000.0	0.0	
21BA		Ramp mode (soft pump)	UINT8	RW	TX/RX			0	1	0	0 = Constant Time 1 = Constant Slope
21BC		P-Gain (soft pump)	FLOAT	RW	TX/RX			0.001	100	0.1	
2258		Reset node	UINT8	RW				0	1	0	

4.13 Pressure Sensor

4.13.1 Mechanical connection requirements

Fast and accurate pressure control requires a fast sensor response. Sensor response time: $< 50\text{ms}$. The sensor is usually connected to the chamber by a pipe. The line must be short enough and the conductance must not be reduced by a too small line diameter or a low conductance shut-off valve. To maintain that the response time is not degraded by this connection it needs to meet the following requirements:

- Inner diameter of connection pipe: $\geq 10\text{ mm}$
- Total length $L1 + L2$: $\leq 300\text{ mm}$

The total conductance value must include all valves and limiting orifices that may also be present. Make also sure that there is no obstruction in front of sensor connection port inside the chamber. The sensor should also be mounted free of mechanical shock and vibration. Dynamic stray magnetic fields may introduce noise to sensor output and should be avoided or shielded.

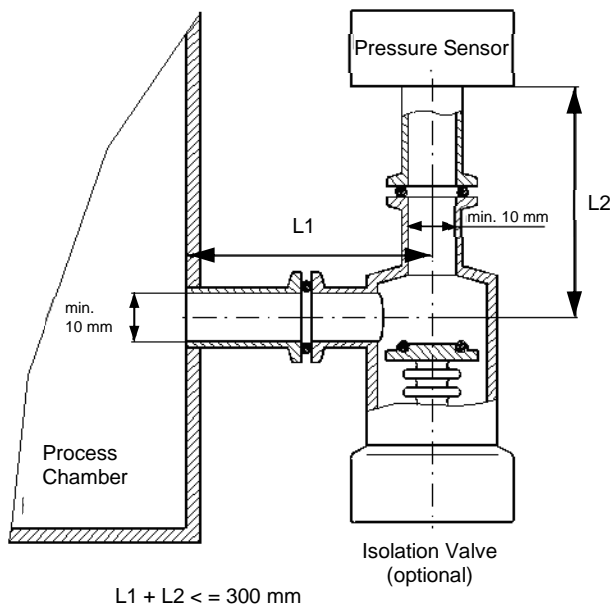

4.13.2 Configuration

The CPA window shows a good overview of the sensor settings:

- The valve supports 2 sensors.
- Zero Adjust is for offset compensation of linear sensors
- Crossover is automatic switch over between 2 linear sensors

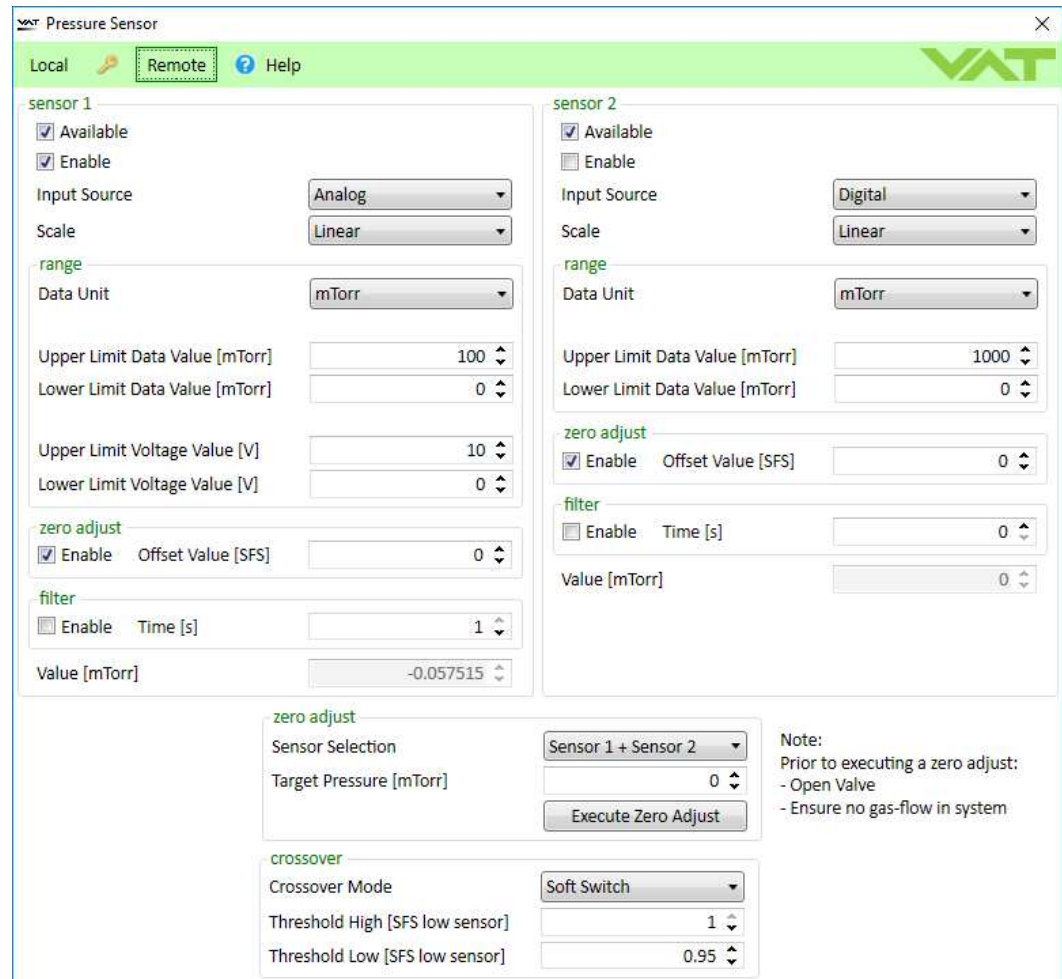

Pressure Sensor

Local Remote Help

sensor 1

Available
 Enable
Input Source: Analog
Scale: Linear
range
Data Unit: mTorr
Upper Limit Data Value [mTorr]: 100
Lower Limit Data Value [mTorr]: 0
Upper Limit Voltage Value [V]: 10
Lower Limit Voltage Value [V]: 0
zero adjust
 Enable Offset Value [SFS]: 0
filter
 Enable Time [s]: 1
Value [mTorr]: -0.057515

sensor 2

Available
 Enable
Input Source: Digital
Scale: Linear
range
Data Unit: mTorr
Upper Limit Data Value [mTorr]: 1000
Lower Limit Data Value [mTorr]: 0
zero adjust
 Enable Offset Value [SFS]: 0
filter
 Enable Time [s]: 0
Value [mTorr]: 0

zero adjust
Sensor Selection: Sensor 1 + Sensor 2
Target Pressure [mTorr]: 0
Execute Zero Adjust

crossover
Crossover Mode: Soft Switch
Threshold High [SFS low sensor]: 1
Threshold Low [SFS low sensor]: 0.95

Note:
Prior to executing a zero adjust:
- Open Valve
- Ensure no gas-flow in system

Location: CPA/Navigation/Parameters: Pressure Sensor.Sensor 1, Pressure Sensor.Sensor 2

Parameter	Description
Available	Set to 'True' if a sensor is connected
Enable	Set to 'True' if the sensor signal is used for pressure control
Input Source	<p>'Analog' Sensor has an analog voltage interface and is direct connected to the valve.</p> <p>'Digital' Sensor has an EtherCAT interface and is connected to the EtherCAT bus</p> <p>'Simulation' Testing the valve and pressure control without being connected to the system</p>
Range.Scale	<p>Select type of the sensor signal</p> <p>'Linear'</p> <p>'Logarithmic'</p> <p>Most gauges are linear type gauges.</p>
Range.Data Unit	<p>Set the pressure data unit of the gauge:</p> <p>Pa, kPa, bar, mbar, Torr, mTorr, psia, psig</p>
Range.Upper Limit Data Value Range.Lower Limit Data Value	<p>Set the upper limit and lower limit of the gauge in the unit of "Range.Data Unit"</p> <p>Example for a 250mTorr linear sensor: Upper Limit = 250.0 Lower Limit = 0.0</p>
Range.Upper Limit Voltage Value Range.Lower Limit Voltage Value	<p>These parameters are only used for gauges with analog voltage interface.</p> <p>The values corresponds to Range.Upper Limit Data Value and Range Lower Limit Data Value</p> <p>Example: Upper Limit: 10.0V → 250mTorr Range Upper Limit Data Value Lower Limit: 0.0V → 0.0mTorr Range Lower Limit Data Value</p>
Filter.Enable	'True' enables the filter
Filter.Type	<p>Set the filter type, which should be applied to the related Sensor Input:</p> <p>Low-pass, Low-pass Simple, Median, Moving Average, Line Frequency Suppression, FIR custom</p>
Filter.Time	<p>Set filter time in the range of 0.0 to 1.0 second.</p> <p>Note: Filter delays the sensor signals which is detrimental for pressure control</p>
Value	The actual Pressure value of the regarding Sensor

4.13.3 Crossover (2 sensor operation mode)

If two sensors are connected to the controller uses both for pressure control and pressure feedback. The controller selects each sensor or blends both sensor signals to the “**Actual Pressure**” used for control and feedback. Three different modes are selectable.

Location: CPA/Navigation/Parameters: Pressure Sensor.Crossover

Parameter	Description
Crossover Mode	Crossover between 2 sensors (see below)
Threshold High [SFS low sensor]	Defines the crossover area (see below)
Threshold Low [SFS low sensor]	The value is related to sensor full scale of low sensor (0.1 means 10% of sensor full scale of low sensor)
Delay	Switch over delay in Crossover Mode ‘Hard Switch’

Crossover Mode Soft Switch

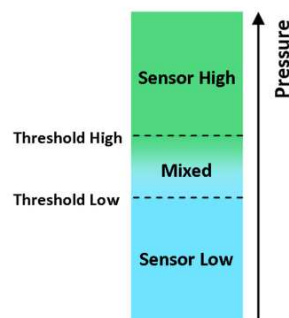

Between the *Threshold Low* and *Threshold High* the controller blends both pressure signals to the actual pressure.

When to use

This is the standard mode. Both pressure signals need to match in the crossover range otherwise crossover effect result (nonlinearity). Sensor full scale ratio low range to high range sensor must not exceed 1:100

Crossover Mode Hard Switch

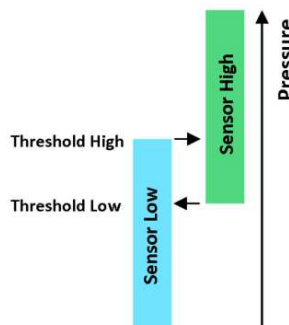

Switching between sensors according to the hysteresis threshold levels and an optional delay.

When to use

Preferred setting if the sensor signals do not fit together in the crossover area (for example if sensor ratio is high).

Crossover Mode Target Pressure

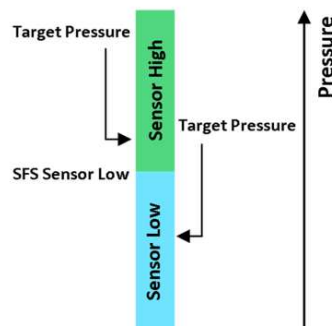

If Target Pressure is below low range sensor full scale low sensor is used; otherwise high range sensor.

When to use

As there is no switchover during pressure control while using this setting, undesired effects like nonlinearity or continuous switching between sensors don't occur.

Note

While in position control mode, 'Soft Switch' mode is used

4.13.4 Zero Adjust

Zero Adjust allows for the compensation of the sensor offset voltage.

Note: A maximum offset voltage of +/- 1.4 V can be compensated.

Location: CPA/Navigation/Parameters: Pressure Sensor.Zero Adjust

Parameter	Description
Zero Adjust.Sensor Selection	Select the sensor for the zero adjust: <ul style="list-style-type: none"> • Sensor 1 + 2 • Sensor 1 • Sensor 2
Zero Adjust.Target Pressure	Normally this parameter is set to 0 in case the process chamber is fully evacuated (pressure <=1‰ of sensor full scale). If not you can align the sensor value to a known pressure (displayed on another readout in the system). In this case set Target Pressure to the known pressure. Note: Target Pressure is in the unit of pressure, see chapter «Scaling of Pressure and Position Values»
Zero Adjust.Execute	1: Start the zero adjust 2: Clear offset value After executing value return to 0
Sensor 1.Enable Sensor 2.Enable	0: It is not possible to execute a zero adjust. A present offset value is ignored 1: It is possible to execute a zero adjust. A present offset value is respected.
Sensor 1.Offset Value [SFS] Sensor 2.Offset Value [SFS]	Value which is deducted from the measured sensor value. The value is related to sensor full scale (0.1 means 10% of sensor full scale)

Performing a zero adjust:

1. Turn the gas flow off
2. Fully open the valve
3. Wait until the sensor signal is not shifting anymore. Refer to manual of sensor manufacturer for warm up time.
4. Wait until process chamber is evacuated.



Do not perform Zero Adjust, if the base pressure of your vacuum system is higher than 1‰ of sensor full scale. We recommend disabling Zero Adjust function or using of Zero Adjust.Target Pressure other than 0.0 in this case. Otherwise incorrect pressure reading is the result.

5. Perform zero with setting of Zero Adjust.Execute to 1
6. Check parameter Actual Pressure if the pressure is shifted as expected

4.13.5 Logarithmic Pressure

To control wide pressure ranges, it is advantageous to control with a logarithmic signal. Note: Only the PI and the Softpump controller can control with a logarithmic signal. Adaptive controller needs a linear signal.

Location: CPA/Parameters: Pressure Sensor.General Settings.Logarithmic Pressure

Parameter	Description
Upper Limit Value	Highest Value of the logarithmic value. Corresponds to the sensor full scale defined in the sensor setup.
Percent Per Decade	Defines the logarithmic scale
Lowest Pressure	Defines the lowest pressure that is converted to a logarithmic value. Corresponds to the smallest valid signal.
Pressure On Interface	Defines which signal scale is used on the interface. Linear Logarithmic
Use Logarithmic Sensor	Set to True to use direct the signal of a logarithmic sensor. Percent Per Decade is then not used. This parameter becomes active only if Pressure Sensor.Sensor X.Range.Scale is set to Logarithmic
Actual Logarithmic Values	Shows the logarithmic value. Full Scale is Upper Limit Value

EXAMPLE:

Sensor 1 linear 1000Torr, Sensor 2 linear 10Torr

With these sensors the measuring range is: 0.001Torr ... 1000Torr, so we cover 6 decades

Percent Per Decade	15 With 15% we cover 6.6 decades (100/15 = 6.6)
Lowest Pressure	0.001Torr (~1mV of Low Sensor)
Upper Limit Value	Shows 1000 (because SFS is 1000)
Actual Logarithmic Value Example Values	Torr 1000 1000 850 100 700 10 550 1 400 0.1 250 0.01 100 0.001
Pressure On Interface	Linear We want the logarithmic signal only on the pressure controller but not on the interface.
Use Logarithmic Sensor	False Since the sensor signal is linear, there is no possibility to use a logarithmic signal from the sensor.

Application: Soft Pump

Use of **Actual Logarithmic Value** in the pressure controller: Set **Pressure Control.Controller X.Control Settings.Pressure Scaler** to **Logarithmic**.

Note: Ramp value use logarithmic signal too, so **Ramp.Slope** is related to logarithmic scale.

For above example: **Slope [Torr]** = 15 means 15 of 1000 per Second what is 1.5% what corresponds to 0.15 Decade per Second.

4.14 Power Connector Digital IO



Do not connect other pins than indicated in the schematics!
Use only screws with 4-40UNC thread for fastening the DA-15 connector!

4.14.1 Digital Input

4.14.1.1 Connection

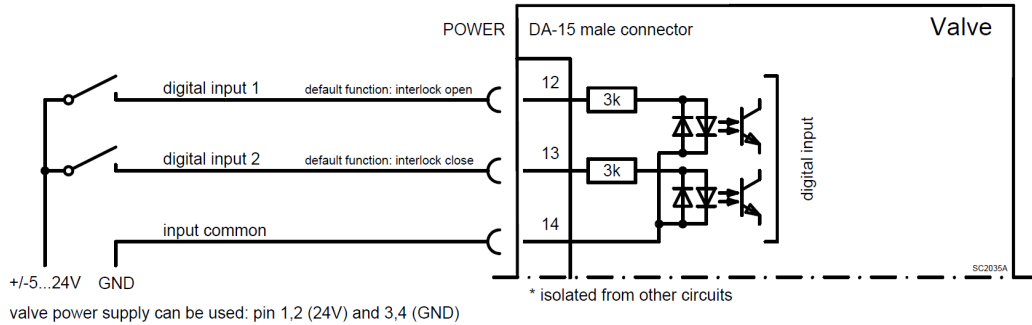

Pin	Default Function
12 INPUT 1	Interlock Open
13 INPUT 2	Interlock Close
14 COMMON	

4.14.1.2 Configuration

Location: CPA/Navigation/Parameters: Power Connector IO.Digital Input

Parameter	Description													
Enable	1 enables the input													
State	0 Not active 1 Active													
Functionality	0 Interlock Open 1 Interlock Close 2 Hold													
Inverted	<table border="1"> <thead> <tr> <th>Input</th> <th>State</th> <th>Function</th> </tr> </thead> <tbody> <tr> <td rowspan="2">0 Not Inverted</td> <td>Off</td> <td>0 Off</td> </tr> <tr> <td>On</td> <td>1 On</td> </tr> <tr> <td rowspan="2">1 Inverted</td> <td>Off</td> <td>1 Off</td> </tr> <tr> <td>On</td> <td>0 On</td> </tr> </tbody> </table>	Input	State	Function	0 Not Inverted	Off	0 Off	On	1 On	1 Inverted	Off	1 Off	On	0 On
Input	State	Function												
0 Not Inverted	Off	0 Off												
	On	1 On												
1 Inverted	Off	1 Off												
	On	0 On												



The INTERLOCK function has **priority** over the remote interface (HOLD does not)
INTERLOCK CLOSE has **priority** over INTERLOCK OPEN

4.14.2 Digital Output

4.14.2.1 Connection

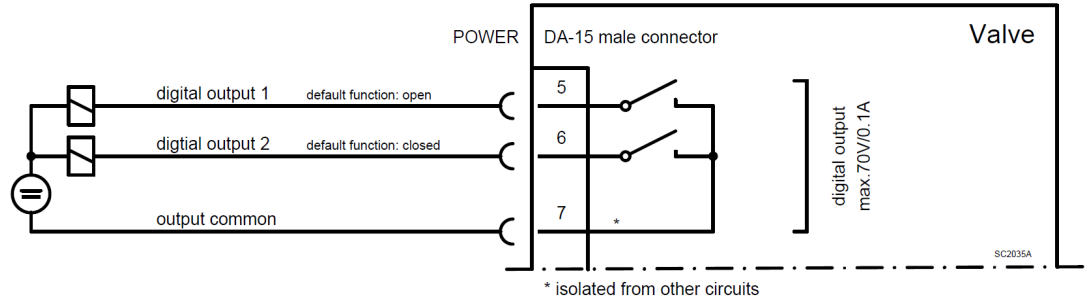

Pin	Default Function
5	OUTPUT 1 Open
6	OUTPUT 2 Closed
7	COMMON

4.14.2.2 Parameter, Configuration

Location: CPA/Navigation/Parameters: Power Connector IO.Digital Output

Parameter	Description																		
Enable	1 enables the output																		
State	0 Not active 1 Active																		
Functionality	0 OPEN valve is fully open 1 CLOSE valve is fully closed (isolated if valve has an isolation function) 2 HOLD valve is in hold state																		
Inverted	<table border="1"> <thead> <tr> <th></th> <th>Function</th> <th>State</th> <th>Output</th> </tr> </thead> <tbody> <tr> <td rowspan="4">0 Not Inverted</td> <td>inactive</td> <td>0</td> <td>Off</td> </tr> <tr> <td>active</td> <td>1</td> <td>On</td> </tr> <tr> <td rowspan="2">1 Inverted</td> <td>inactive</td> <td>1</td> <td>On</td> </tr> <tr> <td>active</td> <td>0</td> <td>Off</td> </tr> </tbody> </table>		Function	State	Output	0 Not Inverted	inactive	0	Off	active	1	On	1 Inverted	inactive	1	On	active	0	Off
	Function	State	Output																
0 Not Inverted	inactive	0	Off																
	active	1	On																
	1 Inverted	inactive	1	On															
		active	0	Off															

5 Operation

	⚠ WARNING
	<p>Unqualified personnel Inappropriate handling may cause serious injury or property damage. Only qualified personnel are allowed to carry out the described work.</p>

	⚠ WARNING
	<p>Valve opening Risk of serious injury. Human body parts must be kept out of the valve opening and away from moving parts. Do not connect the controller to power before the valve is installed complete into the system.</p>

5.1 Access Mode

5.1.1 Overview

Defines whether the interface or the CPA via the service port has the rights to control the valve
Location: CPA/Parameters System

Access Mode	Control Permission	Comment
Local	CPA	
Remote	INTERFACE Master	CPA can switch to Local
Locked	INTERFACE Master	CPA can't switch to Local



Power On state is 'Remote'

5.1.2 Remote and Locked operation

This product is equipped with an interface to allow for remote operation.
 See section «Interface» for details.

'Control Performance Analyzer' software may be used for monitoring during remote control.



In case 'Control Performance Analyzer' is used, make sure 'Remote' button is pushed to enable for remote operation.

5.1.3 Local operation

Local operation means that the valve is operated via the service port using a computer.
 You can use our software 'Control Performance Analyzer' for Local operation, which is integrated in the controller. The software is beneficial especially for setup, testing and maintenance.

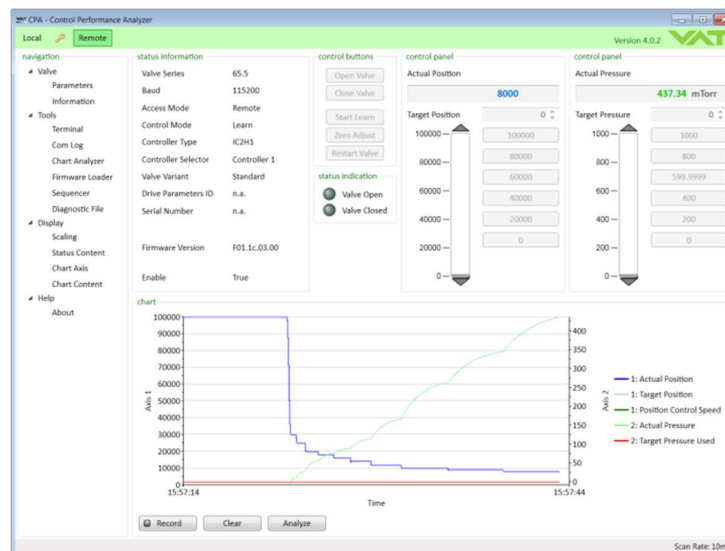

When communication to service port is interrupted the valve will change to remote operation. So when service cable will be disconnected or software will be shut down, the valve returns automatically to remote operation. This may result in an **immediate movement** of the valve depending on remote control.

5.2 Control Mode

The **Control Mode** represents the state machine of the valve. Writing to **Control Mode** requests a change in the state while reading **Control Mode** returns the actual state of the state machine.

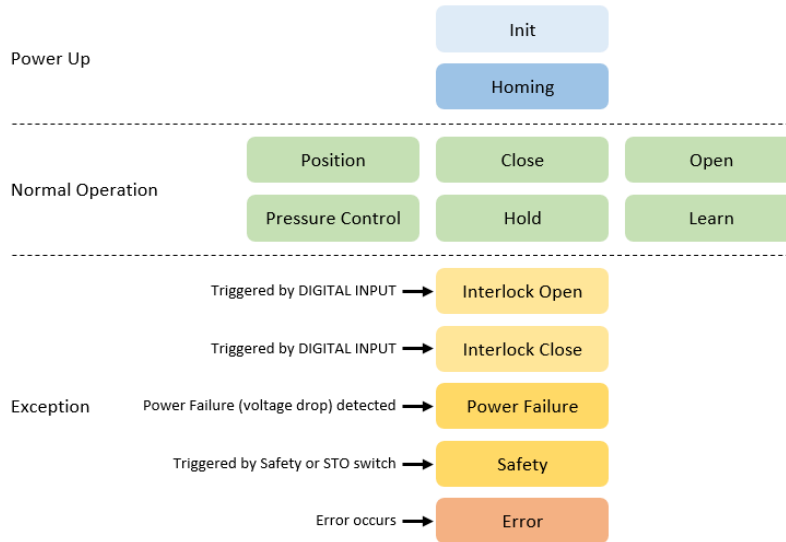

Init	State after power up. Remains if Homing is not started or no Exception occurs
Homing	The valve performs the homing procedure to initialize the position. Refer to chapter Homing
Position	The valve moves to the desired Target Position .
Close	The valve closes.
Open	The valve opens.
Pressure Control	The valve controls to the desired Target Pressure . Refer to chapter Pressure Control
Hold	The valve remains in the actual position. Usage during Pressure Control: Reduce valve reaction during plasma ignition. Stopping the valve movement to evaluate the stability of the sensor, flow meter, ... Note: Change from Control Mode Close to Hold is not possible
Learn	The valve performs the system learn. Necessary for Adaptive Pressure Control. Refer to chapter Pressure Control/Adaptive Algorithm/Learn
Interlock Open	The valve opens and locks due to the actuation of a digital input. Release behavior: Control Mode changes to <i>Open</i> or to <i>Init</i> if no Homing was performed yet. Refer to Chapter Power IO
Interlock Close	The valve closes and locks due to the actuation of a digital input. Release behavior: Control Mode changes to <i>Close</i> or to <i>Init</i> if no Homing was performed yet. Refer to Chapter Power IO
Power Failure	Power loss occurred. The valve opens or closes (Only with optional Power Failure Option) Closing or opening behavior depends on set Power Failure.Functionality Refer to chapter Power Failure
Safety	The motor of the valve is powerless due to a digital input. Release behavior: Control Mode changes to <i>Init</i> Refer to chapter xxx
Error	The valve is in an error state, no movement possible. Recovery via Services.Error Recovery or Services.Restart Controller . Refer to chapter Trouble Shooting.

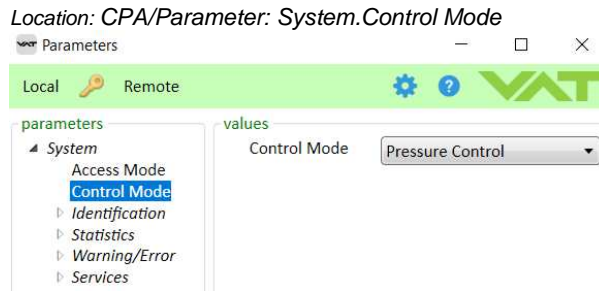

5.2.1 View

CPA

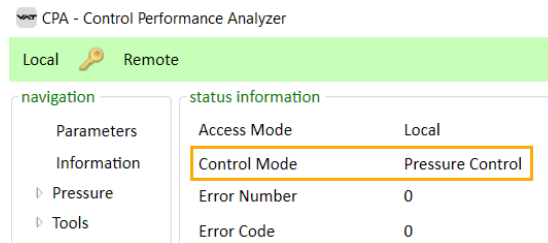

First digit on display



- I Init
- H Homing
- C Close
- O Open
- P Pressure Control
- A Position
- I Interlock Open or Close
- H Hold
- L Learn
- S Safety Mode
- F Power Failure
- E Error

5.3 Pressure Control

5.3.1 Controller units

The valve has four identical pressure controller units. **Controller Selector** defines which unit is used for the pressure control.

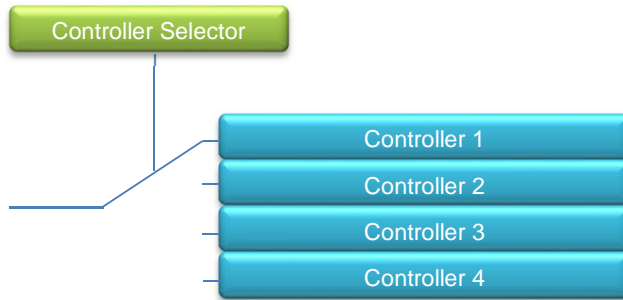

Most applications do not need more than one controller unit. But if the result of the pressure control does not meet the expectations, different controller units can be an option for optimization: With the four controller units it is possible to use a certain controller unit for a specific pressure set point. This controller unit can be parametrized optimally for this specific set point. With the **Automated Controller Selector** (see below) it is possible to change Controller depending on pressure ranges or on up- and down control.

The CPA window 'Pressure Control' shows an good overview of the control units and their features:

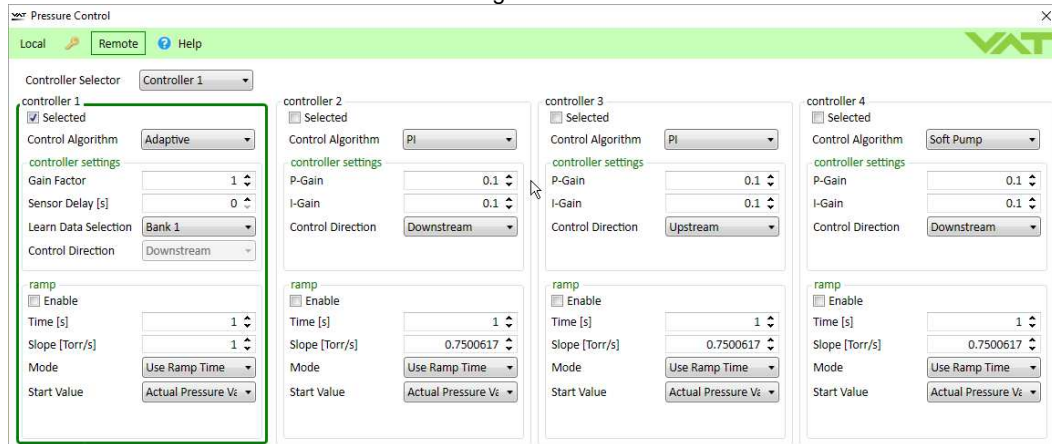

5.3.2 Control algorithm

5.3.2.1 Overview

Adaptive This is the most dynamic control algorithm. Before using adaptive control algorithm, a special procedure called "learn" must be executed first (see chapter below). The valve will observe the behavior of the vacuum system by moving the valve to different positions. During the learn procedure the valve performs an internal parameter estimation correspondent to the vacuum system.

Note: Adaptive control algorithm requires a **linear** sensor signal. If a logarithmic sensor is used the signal has to be linearized or PI algorithm has to be used.

PI This is a solid algorithm for pressure control. The performance will be behind the adaptive control algorithm. But if the condition varies a lot, it's possible that the adaptive control algorithm does not work properly so the PI algorithm provides the best result.

Soft Pump/Vent Is a modified PI control algorithm to pump down from atmospheric pressure or vent to atmospheric pressure. This control algorithm has been optimized to starts very carefully when opening the valve.

5.3.2.2 Choose correct control algorithm

System Configuration	Constant gas flow available		Constant gas flow not available
	Tv* <= 500 sec	Tv* > 500 sec	
<p>Downstream</p>	Adaptive		PI
<p>Upstream</p>		PI	
Soft Pump	Soft Pump		



* Use the formula below to define the applicable pressure control algorithm.

$$T_v = \frac{p_{SFS} \cdot CV}{q_L}$$

- q_L** gasflow for learn [mbar/s]
- p_{SFS}** sensor full scale pressure [mbar]
- T_v*** Vacuum time constant [sec]
- CV** Chamber Volume [l]

5.3.3 Adaptive algorithm

This control algorithm may be used for downstream pressure control.

Before using adaptive control algorithm, a special procedure called “learn” must be executed first (see chapter below).

5.3.3.1 Control Parameter

Location: CPA/Navigation/Parameters: Pressure Control.Controller x.Control Settings

Parameter	Description
Gain Factor	Main parameter to adapt the performance of the pressure control algorithm. A higher gain results in a faster response, higher over- / undershoots of pressure. A lower gain results in slower response, lower over- / undershoot of pressure.
Sensor Delay	For compensation of delays during the pressure detection. Pipes and orifices for sensor attachment can cause delays in response time and could impact badly the pressure control stability. By adapting this parameter to the approximate delay time stability problems can be reduced. But control response time will be slowed down by this measure.
Learn Data Selection	There are up to 4 different learn data sets available. Select which Learn data set the adaptive controller shall use for pressure control.
Ramp	A set point ramp can be use to avoid over shoots... See chapter «Pressure Ramp»

5.3.3.2 Learn

LEARN adapts the PID controller of the valve to the vacuum system and its operating conditions. LEARN must be executed only once during system setup. The LEARN routine determines the characteristic of the vacuum system. Based on this, the PID controller is able to run fast and accurate pressure control cycles.

This characteristic depends on various parameters such as chamber volume, conductance and flow regime. Therefore it must be performed with a specific gas flow according to instruction below. The result of LEARN is a pressure versus valve position data table. This table is used to adapt the PID parameters. The data table is stored in the device memory which is power fail save. The data table can be up-/downloaded via 'Control Performance Analyzer' software or remote interface. Due to encoding the data may not be interpreted directly.

By an OPEN VALVE, CLOSE VALVE, POSITION CONTROL or PRESSURE CONTROL command the routine will be interrupted.

Recorded Standard Learn

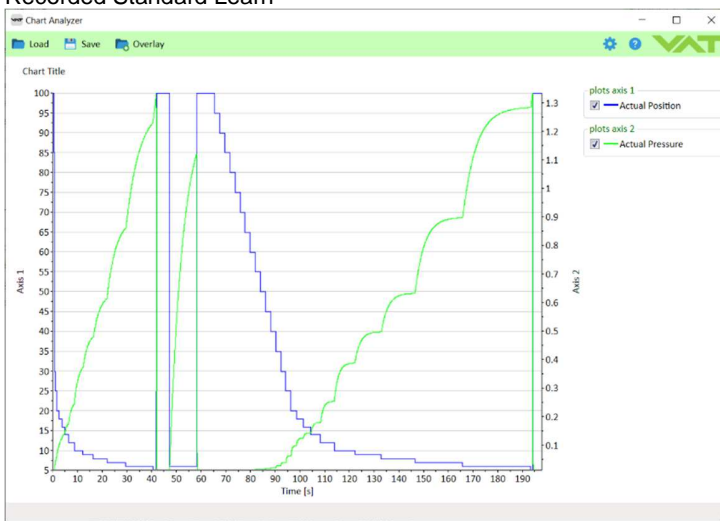

Resulting Learn Data



Parameters Executing

Location: CPA/Navigation/Parameters: Pressure Control.Adaptive Learn

Parameter	Description
Start Learn	Starts the learn
Type	<p>Standard A positioning sequence is executed and various measured values are recorded in the process.</p> <p>Short Opens the valve and measures the pumping speed. Information about flow and volume is required.</p> <p>Calculated Calculated the learn data with the pumping speed information.</p> <p>Short or Calculated can be used when there is no way to set a constant gas flow.</p>
Bank Selection	Select one of four learn bank to place the result of the learn procedure. Note: Be sure pressure controller select this learn bank!
Pressure Limit [SFS]	Limit pressure to which pressure the learn shall be executed. The value is related to the sensor full scale of high sensor. 1.0 means the whole pressure range of the sensors
Pressure Limit	Same value as above but in Pressure Unit
Open Speed	Define the speed for opening the valve during the learn procedure. May be necessary to prevent a pump from crashing. 1.0 means full speed
Status	State of the current learn 0: Not Started 1: In Progress 2: Completed Successfully 3: Aborted 4: Failed
Warning Info	Warning of current learn procedure: Bit 0: Learn is running Bit 1: Checksum error (learn data corrupt) Bit 2: Learn procedure terminated by user Bit 3: Pressure at position open > 50% of pressure limit Bit 4: Pressure at minimal conductance position < 10 % of pressure limit Bit 5: Pressure falls while move valve in direction of close Bit 6: Pressure at open position does not match pressure of previous open Bit 7: Learn procedure terminated by program Bit 8: Pressure <= 0 at open position (no gas flow set?)

Sort Learn Parameter

Parameter	Description
Chamber Volume	Volume above the valve plate in Liter
Gas Flow	Gas flow during the short learn, must be constant during the short learn
Gas Flow Unit	Gas flow unit for above Gas Flow
Pumping Speed	Resulting pumping speed

Calculated Learn Parameter

Parameter	Description
Pumping Speed	Set pumping speed to calculate the learn data

Parameters Learn Bank

Location: CPA/Navigation/Parameters: Pressure Control.Adaptive Learn.Learn Bank x

Parameter	Description
Status	<p>Not Used Empty learn bank</p> <p>Available Data available.</p> <p> Evaluation possible with the pressure position curve in the CPA/Navigation/Adaptive Learn Data</p> <p>Available with warnings The data may still be suitable for pressure control. Evaluation possible with the pressure position curve in the CPA/Navigation/Adaptive Learn Datas</p>
Data	Captured data in a non-readable format
Warning Info	Displays warnings that occurred while learning for this learning bank. Show Warning Info above
Type	<p>Standard</p> <p>Short</p> <p>Calculated</p> <p>..See description above</p>
Delete Learn Bank Data	Deletes the data of the learn bank

Execute a learn procedure

1. Set specific gas flow according to calculation below or the calculation in the CPA → '**Adaptive Learn**' window:

Learn does not need to be performed with the process gas. Instead N₂ or Ar may be used.
2. Set parameter **Bank Selection**, if only one learn is used take Bank 1. Be sure that the pressure controller also selects this learn bank!
3. Reduce **Open Speed** if it is critical for the chamber if the pressure drops rapidly when the valve is opened.
4. Set a **Pressure Limit [SFS]** limit if sensor full scale cannot or should not be reached.
5. Set parameter **Controller Mode** to **LEARN**.
6. Wait until the **Controller Mode** leaves the **LEARN** state → Learn is finished
7. Check if the learn was successful by checking if **Status** shows value 2 (=Completed Successfully). In best case **Warning Info** shows no warning.



- Sensor signal must not shift during LEARN. Wait until sensor signal is stable before LEARN is performed. Learn may take several minutes.
- Do not interrupt the routine as a single full run is required to ensure fast and accurate pressure control.
- The PID controller covers 5% to 5000% of the gas flow which was used for learn.

CPA window 'Adaptive Learn'

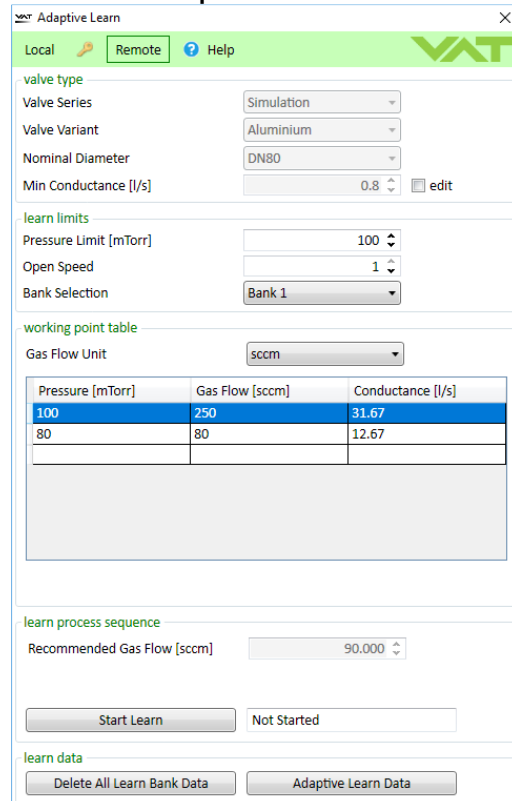

The screenshot shows the 'Adaptive Learn' configuration window with the following sections:

- valve type**: Valve Series (Simulation), Valve Variant (Aluminium), Nominal Diameter (DN80), Min Conductance [l/s] (0.8) [edit]
- learn limits**: Pressure Limit [mTorr] (100), Open Speed (1), Bank Selection (Bank 1)
- working point table**: Gas Flow Unit (sccm)

Pressure [mTorr]	Gas Flow [sccm]	Conductance [l/s]
100	250	31.67
80	80	12.67
- learn process sequence**: Recommended Gas Flow [sccm] (90.000)
- learn data**: Start Learn (Not Started), Delete All Learn Bank Data, Adaptive Learn Data

Gasflow calculation for Learn



Do not apply a different gasflow for learn than determined below. Otherwise pressure control performance may be insufficient. Required pressure / flow regime must be known to calculate the most suitable learn gas flow for a specific application.

Note: The subsequent calculation can be conveniently performed in the CPA/Navigation/Adaptive Learn > Gas Flow Calculation > Calculate

- At first it is necessary to find out about the required control range respectively its conductance values. Each working point (pressure / flow) must be calculated with one following formulas. Choose the applicable formula depending on units you are familiar with.

$$C_{WP} = \frac{1000 \cdot q_{WP}}{p_{WP}}$$

C_{WP} required conductance of working point [l/s]
 q_{WP} **gasflow** of working point [Pa m³/s]
 p_{WP} **pressure** of working point [Pa]

$$C_{WP} = \frac{q_{WP}}{p_{WP}}$$

C_{WP} required conductance of working point [l/s]
 q_{WP} **gasflow** of working point [mbar l/s]
 p_{WP} **pressure** of working point [mbar]

$$C_{WP} = \frac{q_{WP}}{78.7 \cdot p_{WP}}$$

C_{WP} required conductance of working point [l/s]
 q_{WP} **gasflow** of working point [sccm]
 p_{WP} **pressure** of working point [Torr]

- Out of these calculated conductance values choose the lowest.

$$C_R = \min(C_{WP1}, C_{WP2}, \dots, C_{WPn})$$

C_R required lower conductance [l/s]
 C_{WPx} required conductance of working points [l/s]



To make sure that the valve is capable to control the most extreme working point verify that $C_R \geq C_{min}$ of the valve (refer to «Technical data»).

- Calculate gasflow for learn. Choose the applicable formula depending on units you are familiar with.

$$q_L = \frac{p_{SFS} \cdot C_{min}}{1100}$$

q_L gasflow for learn [Pa m³/s]
 p_{SFS} sensor full scale pressure [Pa]
 C_{min} min. controllable conductance of valve [l/s], (refer to «Technical data»)

$$q_L = \frac{p_{SFS} \cdot C_{min}}{1.1}$$

q_L gasflow for learn [mbar l/s]
 p_{SFS} sensor full scale pressure [mbar]
 C_{min} min. controllable conductance of valve [l/s], (refer to «Technical data»)

$$q_L = 71 \cdot p_{SFS} \cdot C_{min}$$

q_L gasflow for learn [sccm]
 p_{SFS} sensor full scale pressure [Torr]
 C_{min} min. controllable conductance of valve [l/s], (refer to «Technical data»)

Evaluation and exchange of learn data

Location: CPA/Navigation/Adaptive Learn Data

The window shows the pressure position curve of the stored data in the learning banks
 With the menu buttons it is possible to exchange data between learn banks and between valves.



5.3.3.3 Tuning

Normally the default settings will result in good pressure control performance. For some applications tuning may be required to improve performance. The tuning procedures for each parameter (grey boxes) and its default values are described separately below. Strictly keep the procedure order.

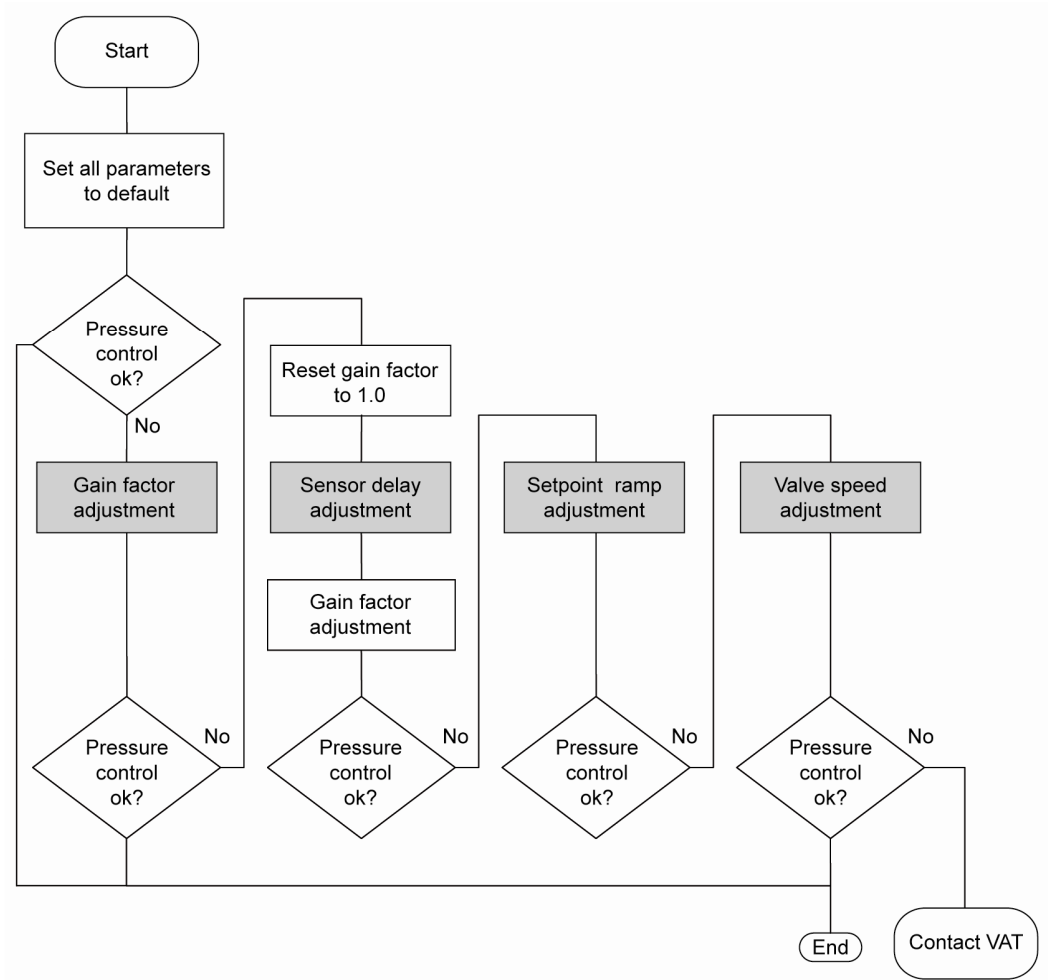

Gain Factor adjustment

The Gain Factor effects: **Stability, Response time**

Adjustment range is from 0.0001 to 100.0

- Higher gain results in: faster response, higher over- undershoot of pressure
- Lower gain results in: slower response, lower over- undershoot of pressure

Adjustment procedure:

1. Start with Gain Factor 1.0
2. Open valve.
3. Control a typical pressure / flow situation.
4. Repeat from step 2 with lower (higher) Gain Factors until optimal pressure response is achieved and stability is ok.



Normally adjustments down to Gain Factors of 0.1 should lead to good results. Otherwise you may need to improve sensor connection. Refer to «Requirements to sensor connection».

Sensor Delay adjustment

Sensor Delay adjustment effects: **Stability**

Adjustment range is from 0.0 to 1.0sec

Pipes and orifices for sensor attachment delay response time and so badly impact pressure control stability.

By adapting this parameter to the approximate delay time stability problems can be reduced. But control response time will be slowed down by this measure.



Whenever possible sensors should be attached to the chamber according to «Requirements to sensor connection». This is the most effective measure against stability issues. If your gauge attachment fulfills these criteria do not use this parameter.

Adjustment procedure:

1. Start with Gain Factor 1.0 and sensor delay 0s.
2. Open valve.
3. Control a typical pressure / flow situation.
4. Repeat from step 2 with higher sensor delays until best possible stability is achieved.
5. Adjustment Gain Factor again. Refer to «Gain factor adjustment».

Setpoint Ramp adjustment

Setpoint Ramp effects: **Undershoot of pressure, Response time**

Note: The ramp is described in detail in capital Pressure Ramp.

This parameter defines the time that is used to decrease / raise pressure between 2 setpoints. Especially in pressure decrease situations at low flows pressure response can be improved much by adapting setpoint ramp time.

Pressure chart

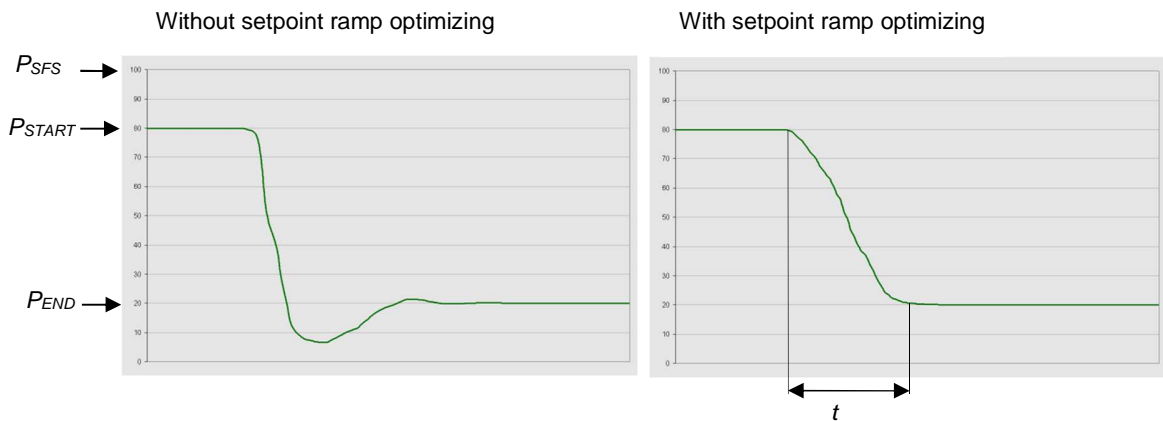

Choose the applicable formula depending on units you are familiar with.

- t - Setpoint Ramp
- P_{SFS} - Pressure at Sensor full scale
- P_{START} - Pressure at start of controlling a pressure step
- P_{END} - Certain pressure, which should be regulated

Adjustment procedure:

1. Start with optimal Gain Factor and sensor delay time according to preceding tuning steps.
2. Control a typical pressure / flow situation.
3. Control a lower pressure.
4. Repeat from step 2 with longer setpoint ramps until best response is achieved.
5. Verify pressure control response for a setpoint raise situation.



In case a long ramp time is required to get optimal performance for pressure decrease situations it may be of advantage to apply different settings for decrease / raise control situations.

Pressure Control Speed adjustment

Valve speed effects: **Response time**

Adjustment range is from 0.001 to 1.0
Default value is 1.0

Location: CPA/Navigation/Parameters: Pressure Control.Pressure Control Speed

This parameter effects valve plate actuating speed.
Speed adjustment is effective for PRESSURE CONTROL and POSITION CONTROL.



Normally best pressure control response is achieved with maximum Pressure Control Speed. In particular applications it may be of advantage to have a slower valve response.
OPEN and CLOSE are always done with maximum speed.

Adjustment procedure:

1. Use optimal Gain Factor, sensor delay time and setpoint ramp according to preceding tuning steps.
2. Open valve.
3. Control a typical pressure / flow situation.
4. Repeat from step 2 with slower Pressure Control Speed until required response is achieved.

Required information for support:

- Go to 'Tools / Create Diagnostic File' in 'Control Performance Analyzer' and save file
- Pressure / flow / gas conditions to be controlled
- Chamber volume
- Pumping speed (l/s) and pump type (e.g. turbo pump)
- System description
- Problem description

Send diagnostic file with and all required information to tuning-support@vat.ch

5.3.4 PI algorithm

This control algorithm may be used for downstream or upstream pressure control depending on configuration.

5.3.4.1 Control Parameter

Location: CPA/Navigation/Parameters: Pressure Control.Controller x,Control Settings

Parameter	Description				
P-Gain	The P-Gain is the proportional factor of the fixed control algorithm. A higher P-Gain results in faster response, higher over- / undershoot of pressure.				
I-Gain	The I-Gain is the integral factor. The I-Gain helps to reach the target pressure exactly.				
Pressure Scale	<table border="0"> <tr> <td>Linear</td> <td></td> </tr> <tr> <td>Logarithmic</td> <td>Recommended if the pressure control extends over several decades. In most cases, the sensor used is a logarithmic sensor anyway.</td> </tr> </table>	Linear		Logarithmic	Recommended if the pressure control extends over several decades. In most cases, the sensor used is a logarithmic sensor anyway.
Linear					
Logarithmic	Recommended if the pressure control extends over several decades. In most cases, the sensor used is a logarithmic sensor anyway.				
Direction	The Control Direction defines the type of application, if the valve is mounted in downstream or upstream. Downstream means the valve is after the chamber and before the pump. Upstream, valve is mounted before chamber and pump.				

5.3.4.2 Tuning

The PI parameters of the pressure controller require correct adjustment. These parameters must be set once during system setup and are stored in the device memory which is power fail save. Based on the PI controller configuration, the valve is able to run fast and accurate pressure control cycles. The PI parameters can be evaluated using below instruction.



- In downstream control mode valve will move towards open when current pressure is higher than set point.
- In upstream control mode valve will move towards close when current pressure is higher than set point.

Introduction

PI controller mode is used if for any reason (e.g. too long system time constant) the adaptive control mode does not provide satisfying control performance.

In PI controller mode the parameters P-Gain and I-Gain have to be set according to the systems characteristics. The best set of parameters can be found by using the empiric method below.

Pressure and gas flow for optimization

A PI controller delivers the best results for a certain working point (pressure/gas flow). If there is only one working point, this pressure and gas flow has to be used for optimizing P and I-Gain. If there are several working points that have to be covered, the pressure for optimizing is the medium pressure between highest and lowest pressure to be controlled, the gas flow for optimizing is the highest flow out of all working points.

Two different pressure set points are necessary for optimization.

Set point 1 (SP1) is the pressure for optimizing as determined above.

Set point 2 (SP2) is about 10 - 20% lower than SP1.

Example: pressure range: 4 – 10 Torr
Flow range: 2 – 4 slm

Pressure set points and gas flow for optimization:

SP1 = 7 Torr
SP2 = 6 Torr
Gas flow = 4 slm

Optimizing P-Gain

While optimizing P-Gain, the gas flow determined above has to be constant all the time.

Start optimization with P-Gain set to 1.0 and I-Gain set to 0.0.

Set chamber pressure to SP2, wait until the pressure is stable. Set pressure to SP1. If the transition from SP2 to SP1 results in a significant pressure over shoot or even does not stabilize at all, the P-Gain is too high. If there is no over shoot and the pressure reaches SP1 asymptotically and very slow, P-Gain is too low.

The optimal P-Gain value is found if the transition from SP2 to SP1 results in a slight pressure over shoot. It does not matter if there is still a deviation between SP1 and actual pressure.

Example:

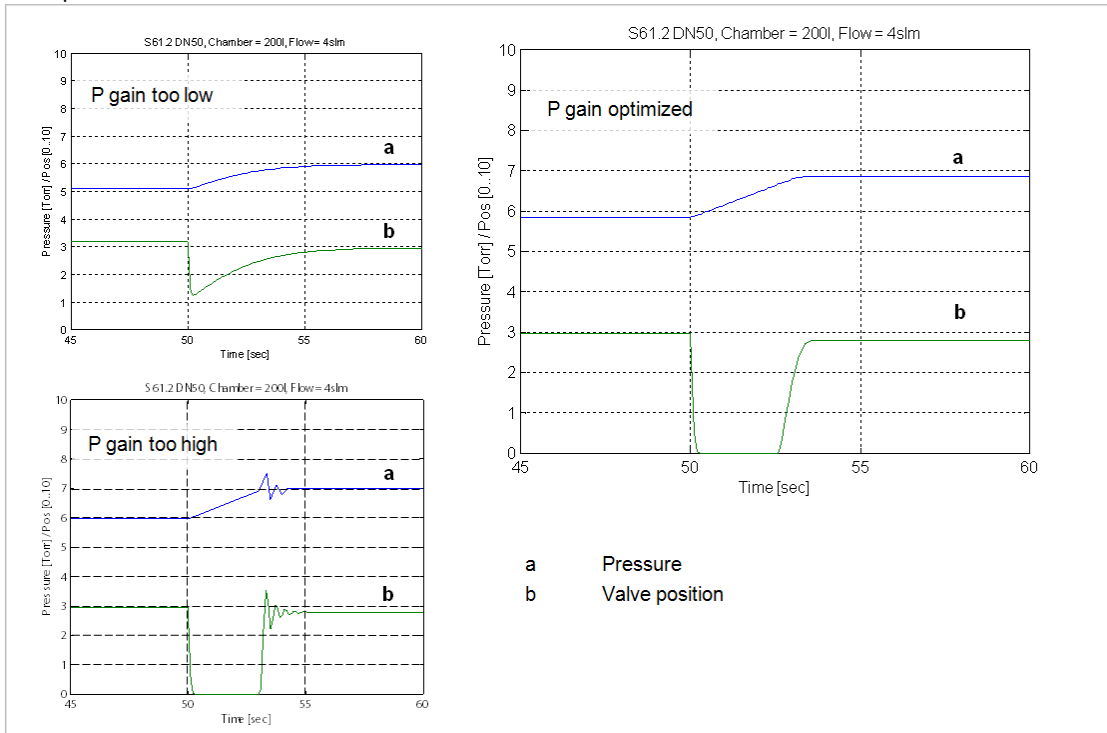

Optimizing I-Gain

While optimizing I-Gain, the gas flow determined above has to be constant all the time.

Start with P-Gain set to half of the value found when optimizing P-Gain and set I-Gain to 1.0. Keep the P-Gain constant.

Set chamber pressure to SP2, wait until the pressure is stable. Set pressure to SP1. If the transition from SP2 to SP1 results in a significant pressure over shoot or if the valve position does not stabilize, I-Gain is too high. If the transition results in a slow asymptotical pressure rise and there is still a constant deviation to SP2, the I-Gain is too low.

The optimal value for I-Gain is found if the transition from SP2 to SP1 result in just a slight pressure over shoot, a stable valve position and the actual pressure matches SP2 exactly.

Example:

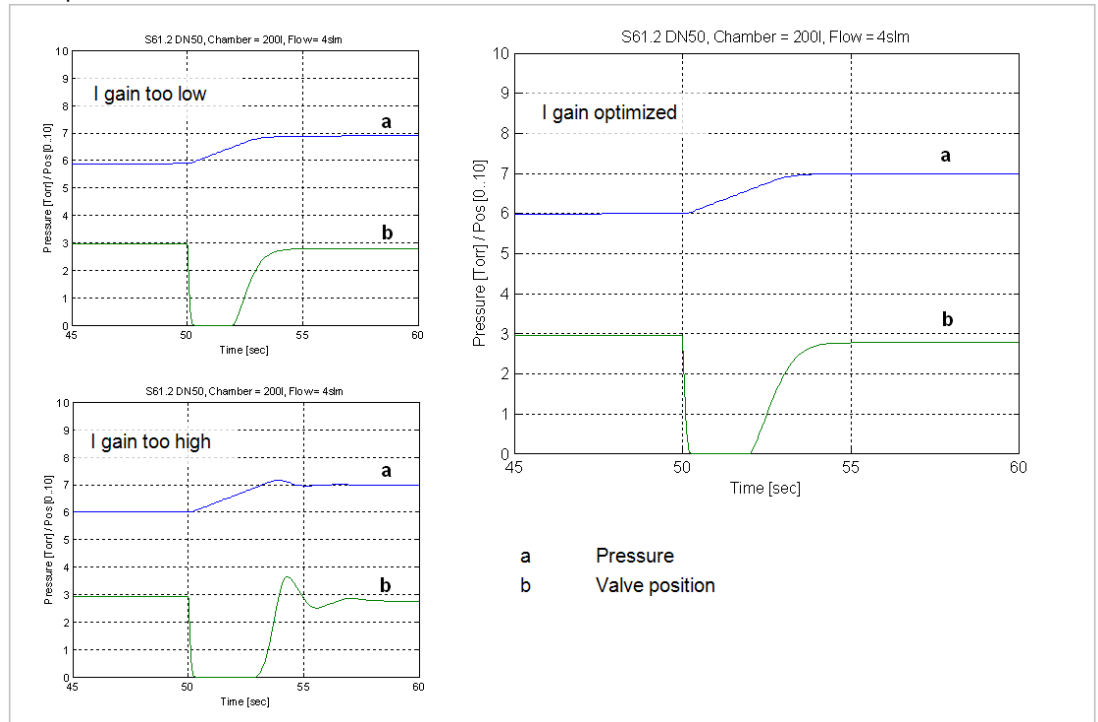

Check control performance over the whole control range with parameters above.

Required information for support:

- Go to 'Tools / Create Diagnostic File' in 'Control Performance Analyzer' and save file
- Pressure / flow / gas conditions to be controlled
- Chamber volume
- Pumping speed (l/s) and pump type (e.g. turbo pump)
- System description
- Problem description

Send diagnostic file with and all required information to tuning-support@vat.ch

5.3.4.3 Soft Pump/Vent algorithm

This control algorithm may be used to control pressure ramps during pump down or venting the chamber. This is a modified PI controller that has been optimized to start up very gently when the valve is opened.

5.3.4.4 Control Parameter

Location: CPA/Navigation/Parameters: Pressure Control.Controller x,Control Settings

Parameter	Description				
P-Gain	The P-Gain is the proportional factor of the fixed control algorithm. A higher P-Gain results in faster response, higher over- / undershoot of pressure.				
I-Gain	The I-Gain is the integral factor. The I-Gain helps to reach the target pressure exactly.				
Pressure Scale	<table border="0"> <tr> <td>Linear</td> <td></td> </tr> <tr> <td>Logarithmic</td> <td>Recommended if the pressure control extends over several decades. In most cases, the sensor used is a logarithmic sensor anyway.</td> </tr> </table>	Linear		Logarithmic	Recommended if the pressure control extends over several decades. In most cases, the sensor used is a logarithmic sensor anyway.
Linear					
Logarithmic	Recommended if the pressure control extends over several decades. In most cases, the sensor used is a logarithmic sensor anyway.				
Direction	The Control Direction defines the type of application, if the valve is mounted in downstream or upstream. Downstream means the valve is after the chamber and before the pump. Upstream, valve is mounted before chamber and pump.				
Ramp	Only the ramp makes the soft pump or soft vent... See chapter «Pressure Ramp»				

5.3.4.5 Tuning

Optimizing P-Gain

Start optimization with P-Gain set to 0.1 and I-Gain set to 0.0.

The control routine has to be controlled as follows:

- Move control valve into close position
- Start pump down by opening the pump isolation valve or starting the pump
- Send the pressure set point to the valve controller.

While pumping/venting the chamber pressure and valve position should be data logged to compare the actual curve with the ideal straight pump/venting line.

If the pressure follows the ideal pump/venting line with significant delay, the P-Gain is too low.

If the pressure oscillates around the ideal pump/venting line or if the valve position oscillates, P-Gain is too high.

P-Gain is optimized if the pressure follows the ideal pump down line closely and the valve position is not oscillating at all.

Optimizing I-Gain

Start with P-Gain set to half of the value found when optimizing P-Gain and set I-Gain to 1.0. Keep the P-Gain constant.

If the pressure follows the ideal pump/venting line with significant delay, the I-Gain is too low.

If the pressure oscillates around the ideal pump/venting line or if the valve position oscillates, I-Gain is too high.

I-Gain is optimized if the pressure follows the ideal pump down line closely and the valve position is not oscillating at all.

Example:

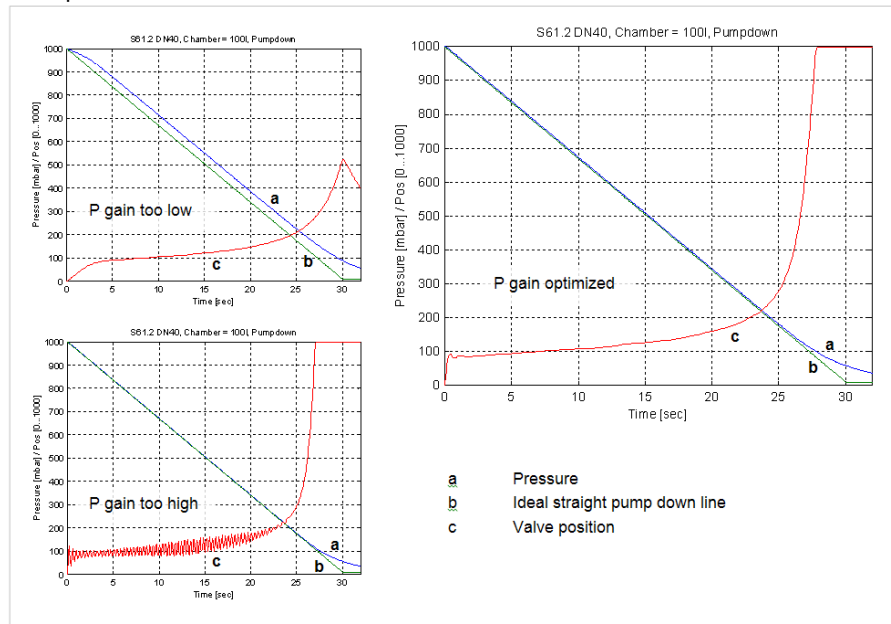

Optimizing I-Gain

I-Gain is responsible to reach the setpoint. If reaching setpoint is not important (e.g. setpoint is 0) leave the I-Gain at 0. Otherwise start with P-Gain set to half of the value found when optimizing P-Gain and set I-Gain to 0.1. Keep the P-Gain constant. Start again the pump down. Check how the pressure reaches the setpoint:

If the setpoint is reached too slowly increase I-Gain

If there is an undershoot increase I-Gain

Required information for support:

- Go to 'Tools / Create Diagnostic File' in 'Control Performance Analyzer' and save file
- Pressure / flow / gas conditions to be controlled
- Chamber volume
- Pumping speed (l/s) and pump type (e.g. turbo pump)
- System description
- Problem description

Send diagnostic file with and all required information to tuning-support@vat.ch

5.3.5 Pressure Ramp

Basically, the pressure ramp is used to limit the rate of pressure change.

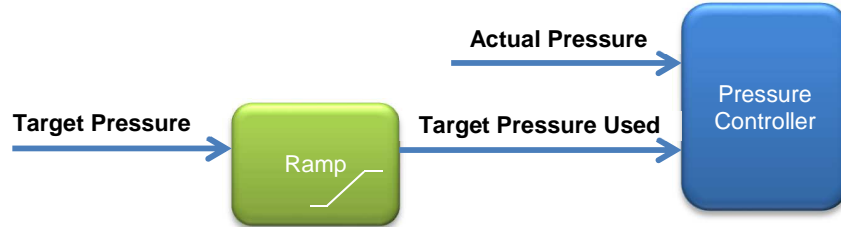

5.3.5.1 Configuration

Location: CPA/Navigation/Parameters: Pressure Control.Controller x.Ramp

Parameter	Description
Enable	Activate / Deactivate pressure target ramp
Mode	0:Use Ramp Time 1:Use Ramp Slope See description below
Time	Target reach time in seconds (Used if Mode = 0)
Slope	Limit the rate of pressure change in pressure per seconds (Used if Mode = 1)
Type	0:Linear 1:Logarithmic 2:Exponential
Start Value	0:Previous Ramp Value 1:Actual Pressure Value



5.3.5.2 Mode

Time

Unit: seconds

Time is constant, slope varies

Example: 2 sec

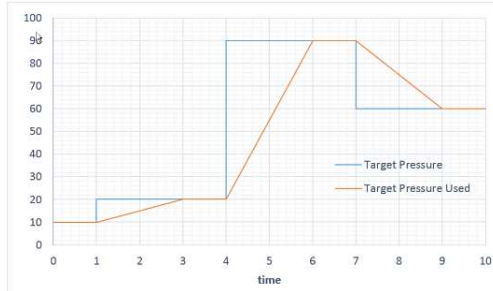

Slope

Unit: Pressure / seconds

Slope is constant, time varies

Example: 10mTorr/second

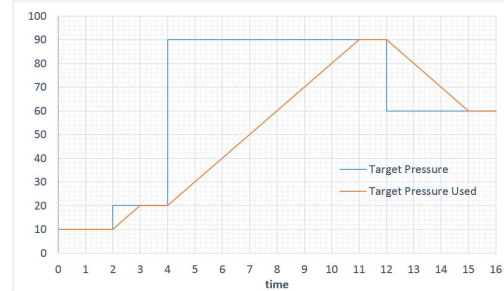

5.3.5.3 Type

Linear

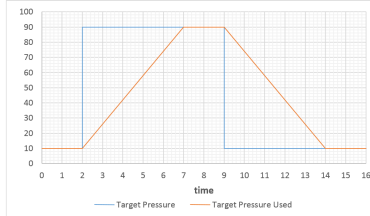

Logarithmic

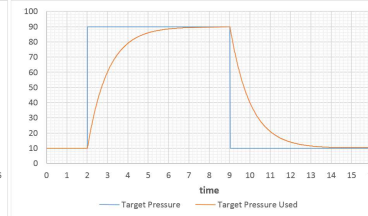

Exponential

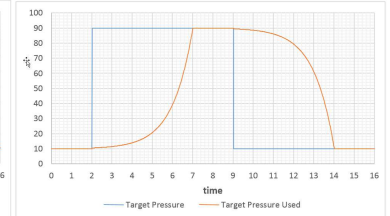

5.3.5.4 Applications Examples

Soft pump

Ramp Mode = Time
 Ramp Time = 100 sec
 Ramp Type = Linear
 Target Pressure = 0

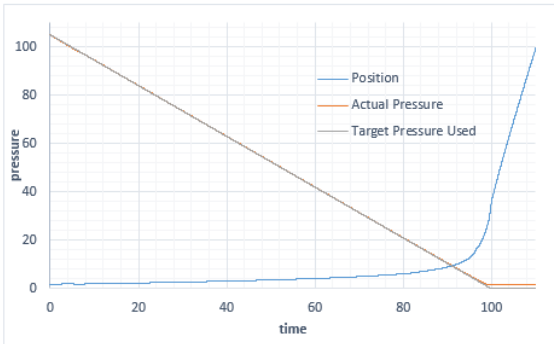

Minimize pressure over- or undershoots

New Target Pressure without pressure ramp

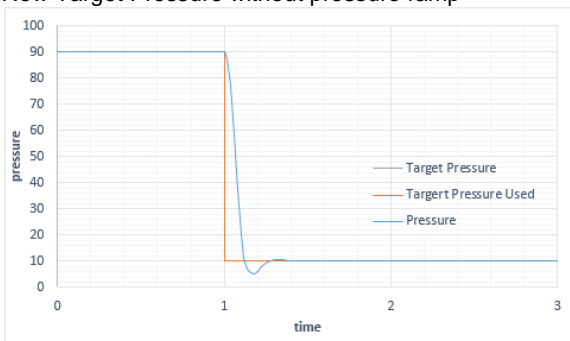

New Target Pressure with pressure ramp

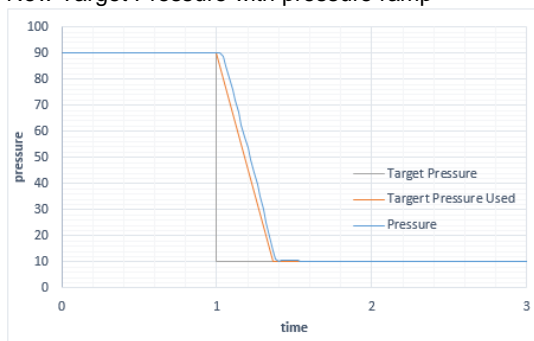

Smoothing a staircase

Pressure ramp with new target pressure to the valve every second is smoothed by a 1 sec internal ramp
 Ramp Time = 1sec

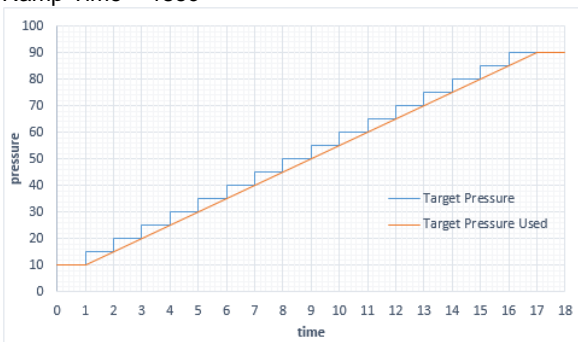



5.3.6 Profile Ramp

Profile Ramp is a **Target Pressure** ramp that depends on pressure ranges (segments). It is mainly used to create soft pumping or soft venting profiles.

To design a profile, the segments (pressure ranges) must be defined. A segment is defined by the pressure **Threshold** and the **Slope**. It is possible to define up to 10 segments.

Example: Ramp Profile with 3 segments

Segment Nr	Threshold mBar*	Resulting Segment mBar*	Slope mBar*/sec
1	1000	500 to 1000	50
2	500	200 to 500	100
3	200	0 to 200	200

Result is a Target Pressure Ramp (**Target Pressure Used**) with different slopes depending on pressure ranges:

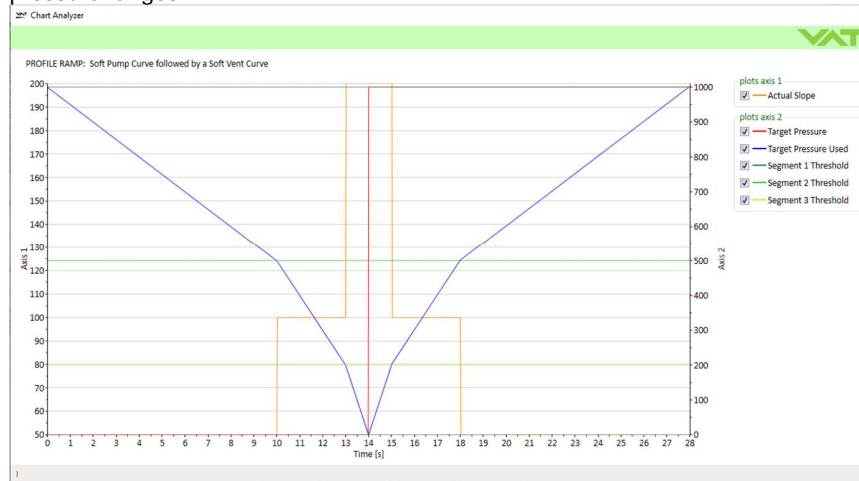

Parameters:

Location: CPA/Navigation/Parameters: Pressure Control.General Settings.Profile Ramp

Parameter	Description
Enable	Switches on/off the function
Threshold Mode	Defines which pressure the threshold refers to

Actual Pressure

Change happens if **Actual Pressure** reaches the **Threshold**

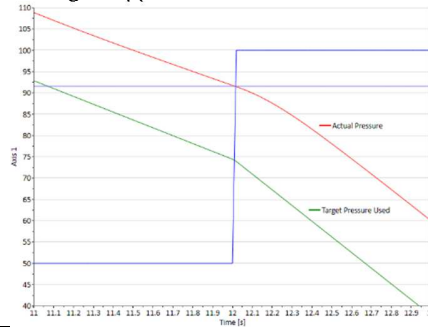

Target Pressure Used

Change happens if **Target Pressure Used** reaches the **Threshold**

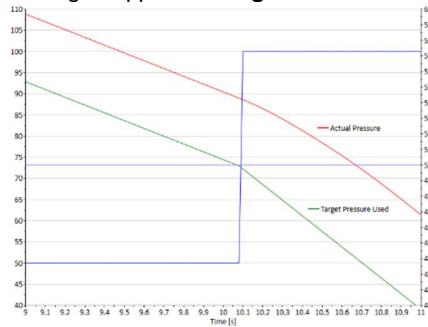

Ramp Type	Defines the shape of the ramp Linear Logarithmic Exponential
Actual Slope	Show the actual use slope during pressure control in mBar*/sec.
Controller Selector	Determines which Controller uses the profile ramp.
Bitmap	When a Controller is selected, the ramp is no longer used in the controller itself. Therefore the ramp is greyed out in the CPA.

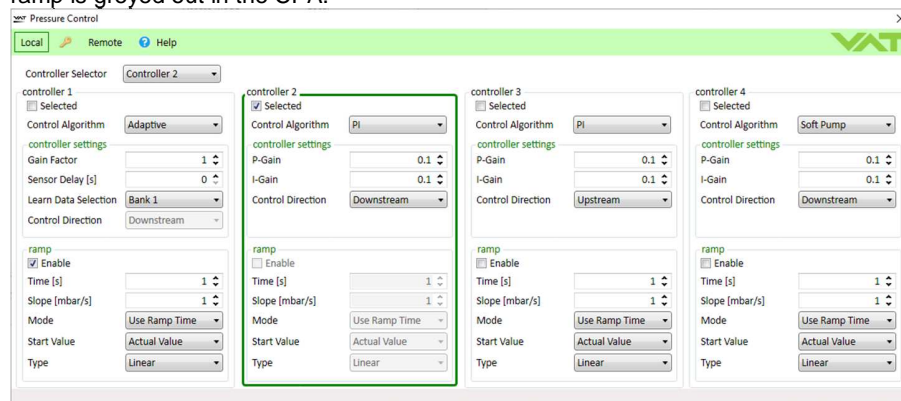

Segment Selector	Defines which segments is used for the Profile Ramp.
Bitmap	

**Segment x
Threshold**

This is the upper limit of the segment. The lower limit is defined by the next lower **Threshold**, or the lower limit is 0 if there is no lower **Threshold**.
If the value exceeds the top threshold, the slope value of the top segment is used (Segment 1 in below example)

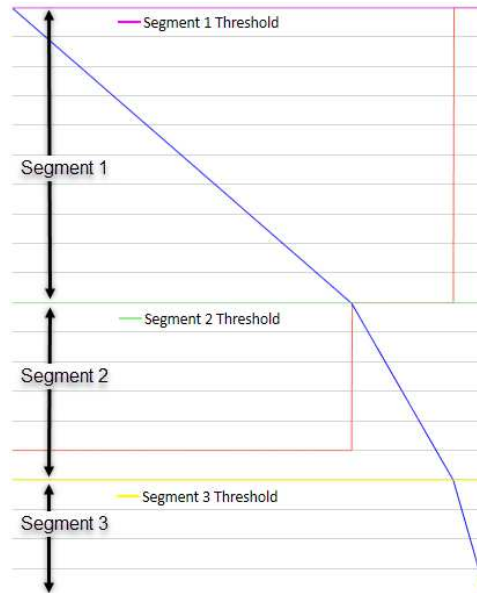
Segment x Slope

Defines the slope (mBar*/sec) in the segment

* Unit adjustable

5.3.7 Automated Controller Selector

With the 4 Controllers it is possible to define different pressure control settings. The Automated Controller Selector can select one of the 4 Controllers depending on Target Pressure (**Mode: Threshold**) or Up-Down Control (**Mode: Pressure Direction**)

Mode: Threshold
Threshold Condition: Lower or Equal
Controller Selector changes when the Target Pressure exceeds or falls below a Threshold value



Mode: **Threshold**

Controller Selector Bitmap: 15

Threshold Condition: **Lower or Equal**

Controller 1 Threshold: [mbar] 100

Controller 2 Threshold: [mbar] 200

Controller 3 Threshold: [mbar] 400

Controller 4 Threshold: [mbar] 1000

Threshold Condition: Equal
Controller Selector changes only when the Target Pressure is equal to a Threshold value

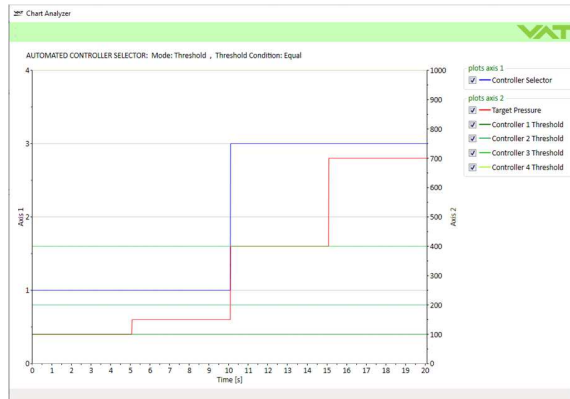

Mode: **Threshold**

Controller Selector Bitmap: 15

Threshold Condition: **Equal**

Controller 1 Threshold: [mbar] 100

Controller 2 Threshold: [mbar] 200

Controller 3 Threshold: [mbar] 400

Controller 4 Threshold: [mbar] 1000

Mode: Pressure Direction
Controller Pressure Rising: Controller 1
Controller Pressure Falling: Controller 2
Controller Selector changes depending on whether Target Pressure is rising or falling

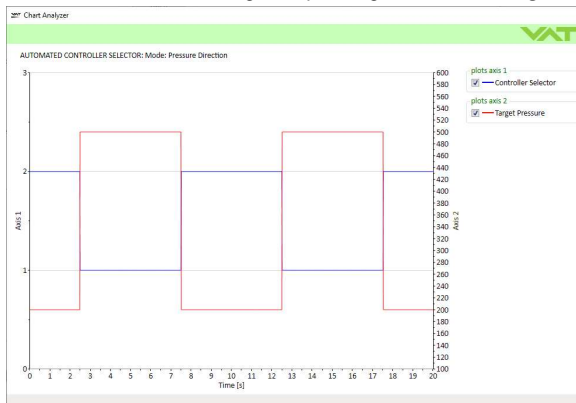

Mode: **Pressure Direction**

Controller Pressure Rising: **Controller 1**

Controller Pressure Falling: **Controller 2**

Parameter:

Location: CPA/Navigation/Parameters: Pressure Control.General Settings.Automated Controller Selector

Parameter	Description
Enable	Switches on/off the function
Mode	Threshold Pressure Direction
Controller Selector Bitmap	Used if Mode = Threshold Defines which controllers are automatically selected
Threshold Condition	Used if Mode = Threshold Lower or Equal Equal The Thresholds are related to Target Pressure
Controller 1 Threshold Controller 2 Threshold Controller 3 Threshold Controller 4 Threshold	Used if Mode = Threshold The Thresholds are related to Target Pressure
Controller Pressure Rising Controller Pressure Falling	Used if Mode = Pressure Direction Select one Controller for up control and one for down control Controller 1 Controller 2 Controller 3 Controller 4

5.3.8 Control Position Restriction

Location: CPA/Navigation/Parameters: Pressure Control.General Settings.Control Position Restriction

Parameter	Description
Enable	False True
Minimum Control Position	Defines the lowest position during pressure control
Maximum Control Position	Defines the highest position during pressure control
Restriction Active	False True

5.3.9 Store Control Parameter Volatile

Used when the control parameters are changed frequently during the process and it is not useful to store the value in the non-volatile memory each time (the lifetime of the non-volatile value is 1 million memory cycles).

Only effective on the interface, the settings via CPA are always stored in non-volatile memory

Location: CPA/Navigation/Parameters: Pressure Control.General Settings

Parameter	Description
Store Control Parameter Volatile	False True

5.4 Position Control

5.4.1 Parameter

Location: CPA/Navigation/Parameters: Position Control

Parameter	Description
Actual Position	Position of the valve plate Range depends on Position Scaling setting (on Interface and CPA)
Target Position	Desired position of the valve plate Range depends on Position Scaling setting (on Interface and CPA)
Position Control Speed	Speed of the valve in Control Mode Position 0.001 .. 1.0 (Full speed)
Ramp	See below

5.4.2 Position Ramp



5.4.2.1 Configuration

Location: CPA/Navigation/Parameters: Position Control.Ramp

Parameter	Description
Enable	Activate / Deactivate position ramp
Mode	0:Use Ramp Time 1:Use Ramp Slope See description below
Time	Target reach time in seconds (Used if Mode = 0)
Slope	Limit the rate of position change per second (Used if Mode = 1)
Type	0:Linear 1:Logarithmic 2:Exponential

5.4.2.2 Mode

Time

Unit: seconds
 Time is constant, slope varies
 Example: 2 sec

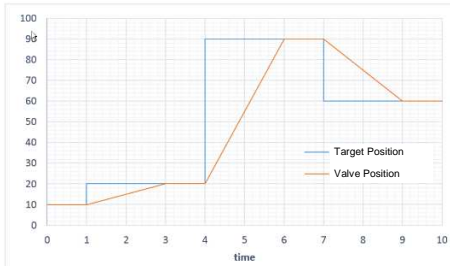

Slope

Unit: %* / seconds
 Slope is constant, time varies
 Example: 10% / sec

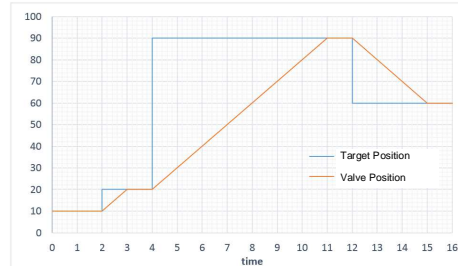

* Unit adjustable

5.4.2.3 Type

Linear

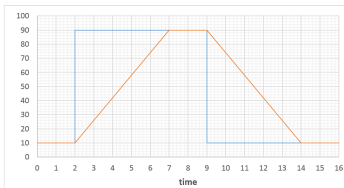

Logarithmic

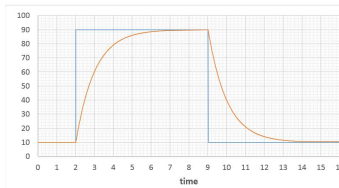

Exponential

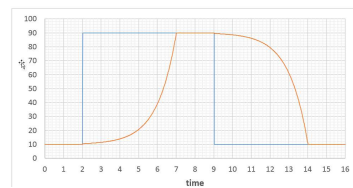

5.5 Operation under increased temperature

	<p>CAUTION</p>
	<p>Hot valve Heated valve may result in minor or moderate injury. Do not touch valve and heating device during operation. Once heating is switched off (valve and system) await until the valve is cooled down complete before doing any work.</p>



This valve may be operated in the temperature range mentioned product data sheet.

	<p>WARNING</p>
	<p>O-ring sticking Due to the sticking properties of elastomer O-rings being cooled down from high temperatures, operator/ integrator must ensure that the vacuum product has a similar temperature during opening of the valve as it had been for the previous closing. Otherwise, there is a high risk of damaging the O-ring.</p>

6 Trouble shooting

6.1 Warnings



A warning does not lead to an interruption of valve operation.

Location: CPA/Parameters: System.Services

Parameter	Description		
Warning Bitmap	Bit	Hex	Description
	0	1	No learn data available for adaptive control
	1	2	Position indicator signal of the external isolation valve incorrect.
	2	4	No Sensor Active
	3	8	PFO Not Ready
	4	16	Cluster Slave Offline
	6	40	Fieldbus Data Not Valid
	8	256	Compressed Air Not Falling when valve close
	9	512	Compressed Air Too Low
	10	1024	Compressed Air Too High
	12	4096	Fan stall alarm

Failure	Check	Action
Display does not light up	- 24 V power supply	- Connect valve to power supply according to 'Power, ground and sensor connection' and make sure that power supply is working.
Remote operation does not work	- Local operation via service port active	- Switch to remote or locked operation Refer to 'Remote and local operation'
	- Safety mode active Check for S on display	- Check 'Drive Power Enable Switch' Refer to 'Power, ground and sensor connection'
	- Interlock mode active Check for I on display	- Check Digital Input Refer to 'Power connector IO' → 'Digital Input'
POSITION CONTROL does not work	- Safety mode active Check for S on display	- Check 'Drive Power Enable Switch' Refer to 'Power, ground and sensor connection'
	- Interlock mode active Check for I on display	- Check Digital Input Refer to 'Power connector IO' → 'Digital Input'
	- POSITION CONTROL selected, check for A on display?	- Select POSITION CONTROL mode. Refer to 'Control Mode' in 'EtherCAT' interface
Pressure reading is wrong	- Sensor connection	- Refer to 'Power, ground and sensor connection'
Pressure reading is negative	- ZERO done?	- Perform ZERO when base pressure is reached. Refer to 'Pressure Sensor' → 'Zero Adjust'
	- Does sensor power supply provide enough power for sensor(s)?	- Verify sensor supply voltage.
ZERO does not work	- ZERO disabled?	- Enable ZERO. Refer to 'Pressure Sensor' → 'Zero Adjust'
	- Sensor voltage shifting?	- Wait until sensor does not shift any more before Performing ZERO.
Pressure is not '0' after ZERO	- System pumped to base pressure?	- OPEN VALVE and bring chamber to base pressure before performing ZERO.
	- Sensor offset voltage exceeds ±1.4V	- Adjust the offset direct at the sensor - Check function of the sensor.
PRESSURE CONTROL does not work	- PRESSURE CONTROL selected, check for P on display?	- Select PRESSURE CONTROL mode. Refer to 'Control Mode' in 'EtherCAT' interface
	- LEARN done?	- Perform LEARN. Refer to 'Pressure control' → 'Adaptive algorithm' → 'Learn'
	- Sensor signal ok?	- Refer to 'Pressure Sensor'
	- Pressure control setup done	- Refer to 'Pressure control'
PRESSURE CONTROL not optimal	- LEARN successfully done?	- Perform LEARN. Check 'Status' and 'Warning Info' in 'Pressure control' → 'Adaptive algorithm' → 'Learn'
	- ZERO performed before LEARN?	- Perform ZERO then repeat LEARN. Refer to 'Pressure Sensor' → 'Zero Adjust'
	- Was gas flow stable during LEARN?	- Repeat LEARN with stable gas flow. Refer to 'Pressure control' → 'Adaptive algorithm' → 'Learn'
	- Tuning done?	- Tune valve for application. Refer to the tuning sections in 'Pressure Control'
	- Is sensor range suited for application?	- Use a sensor with suitable range (controlled pressure should be >3% and < 98% of sensor full scale).
	- Noise on sensor signal?	- Make sure a shielded sensor cable is used.

6.2 Errors

 If valve is in Control Mode Error, movement is no longer possible.

The following parameters provide information about the cause of the error:

Location: CPA/Parameters: System.Services

Parameter	Description
Error Bitmap	Information about the types of errors. Details below.
Error Number	Information about the error component. Details below. Also shown on the controller display when active.
Error Code	Information about the different error states. Details below. Also shown on the controller display when active.

 If you need any further information, please contact one of our service centers. You will find the addresses on our website: www.vatvalve.com

The following information is required for VAT to analyze the error case:

- Diagnostic File: CPA → Tools → Diagnostic File
- Load Error Data: CPA → Tools → Trace Log → Mode Load Error Data → Start

6.2.1 Error Recovery

To leave the error state, the **Error Recovery** or **Restart Controller** can be used:

Location: CPA/Parameters: System.Services

Parameter	Description
Restart Controller	Emulates a power cycle of the valve
Error Recovery	Attempts to reset the Control Mode Error without restarting the valves

 Create a diagnostic file before recovery or restart if the error is to be analyzed by VAT

6.2.2 Error Bitmap

Parameter	Description		
Error Bitmap	Bit	Hex	Description
	0	1	Homing Position Error
	1	2	Homing Not Running
	2	4	Homing Error State
	3	8	Operation Position Error
	4	10	Operation Not Running
	5	20	Operation Error State
	12	1000	Other Component
	30	40000000	General
	31	80000000	Internal

6.2.3 Error Number



Error numbers are three-digit decimal numbers (**xyz**) whereas:

x = component	y = mode	z = error type
1 = All Motor Units	0 = Homing	0 = Position Error ¹⁾
2 = Motor Unit 1	2 = Operation Mode	1 = Not running: No communication with component x
3 = Motor Unit 2	8 = Other	2 = Error State: component x is running but in Status Error
4 = Motor Unit 3		8 = Other
8 = Other		

6.2.4 Error Code

¹⁾ Mechanical movement problem:

- Check for differential pressure
- Remove foreign object in movement area
- Eliminate tight movement
- Repair mechanical failure

Code	Description	Solution
1	No valve connected	Connect valve controller to the valve
2	Nonvolatile memory failure	Replace valve controller
3	Analog digital converter of sensor input failure	Replace valve controller
4	Initialization of motion controller failed	Wrong motion controller firmware version → Update motion controller firmware
5	Encoder index pulse not found	<ul style="list-style-type: none"> • ¹⁾ • Encoder failure • O-ring sticking
6	Initialization of interface module failed	<ul style="list-style-type: none"> • Fieldbus: Valve firmware does not support interface type → Update valve firmware • Wrong interface firmware version → Update interface firmware
7	Initialization of external drive EEPROM failed	Check cables
10	Closing position can't be reached	¹⁾
11	Homing position can't be reached	<ul style="list-style-type: none"> • ¹⁾ • Plate not mounted
12	Motion controller: Internal voltage error	Check power supply
13	Motion controller: Internal error temperature	Check for a heat accumulation
14	Motion controller: Unexpected behavior	Contact vat support <ul style="list-style-type: none"> • Axis inverted • Encoder not connected • Break not released
15	Motion controller: Target position can't be reached	<ul style="list-style-type: none"> • ¹⁾ • Current Settings
16	Motion controller: Position minimal conductance cannot be reached	<ul style="list-style-type: none"> • ¹⁾ • Check Plate and Seal ring • Check Parameter "Isolation Position Enter [r]"
17	Motion controller: Position to push back the Differential Plate cannot be reached	<ul style="list-style-type: none"> • ¹⁾ • Check Different Plate • Check Parameter "Differential Plate Push Back Position [r]"
18	Motion controller: Minimal isolation position cannot be reached	<ul style="list-style-type: none"> • ¹⁾ • Check Plate and Seal ring • Check Parameter "Isolation Position [r]"
20	Break slippery detected	Replace actuator

Code	Description	Solution
30	SFV: Motion controller failure in master-slave communication	Contact vat support
40	Compressed air error	Check compressed air
42	Power supply, low voltage detected	Check if power supply is ok and is able to deliver needed power
96	SFV: Position deviation axis1 to axis2 at homing procedure	<ul style="list-style-type: none"> • ¹⁾ • O-ring sticking
97	SFV: Position deviation axis1 to axis2 at operating	¹⁾
98	Position error during closing procedure	¹⁾
99	Position error at operating	¹⁾
200	Valve configuration error, not possible to operate the valve with these configuration	Contact VAT support
701	Wrong ident code axis 1	Check wiring
702	Wrong ident code axis 2	
703	Wrong ident code axis 2 AND axis 1	
704	Wrong ident code axis 3	
705	Wrong ident code axis 3 AND axis 1	
706	Wrong ident code axis 3 AND axis 2	
707	Wrong ident code axis 3 AND axis 2 AND axis 1	
707	Do not operating mode active	

6.3 Troubleshooting List

Failure	Check	Action
Display does not light up	- 24 V power supply	- Connect valve to power supply according to 'Power, ground and sensor connection' and make sure that power supply is working.
Remote operation does not work	- Local operation via service port active	- Switch to remote or locked operation Refer to 'Remote and local operation'
	- Safety mode active Check for S on display	- Check 'Drive Power Enable Switch' Refer to 'Power, ground and sensor connection'
POSITION CONTROL does not work	- Interlock mode active Check for I on display	- Check Digital Input Refer to 'Power connector IO' → 'Digital Input'
	- Safety mode active Check for S on display	- Check 'Drive Power Enable Switch' Refer to 'Power, ground and sensor connection'
	- Interlock mode active Check for I on display	- Check Digital Input Refer to 'Power connector IO' → 'Digital Input'
POSITION CONTROL does not work	- POSITION CONTROL selected, check for A on display?	- Select POSITION CONTROL mode. Refer to 'Control Mode' in 'EtherCAT' interface
	- Sensor connection	- Refer to 'Power, ground and sensor connection'
Pressure reading is wrong	- ZERO done?	- Perform ZERO when base pressure is reached. Refer to 'Pressure Sensor' → 'Zero Adjust'
Pressure reading is negative	- Does sensor power supply provide enough power for sensor(s)?	- Verify sensor supply voltage.
ZERO does not work	- ZERO disabled?	- Enable ZERO. Refer to 'Pressure Sensor' → 'Zero Adjust'
	- Sensor voltage shifting?	- Wait until sensor does not shift any more before Performing ZERO.
Pressure is not '0' after ZERO	- System pumped to base pressure?	- OPEN VALVE and bring chamber to base pressure before performing ZERO.
	- Sensor offset voltage exceeds ±1.4V	- Adjust the offset direct at the sensor - Check function of the sensor.
PRESSURE CONTROL does not work	- PRESSURE CONTROL selected, check for P on display?	- Select PRESSURE CONTROL mode. Refer to 'Control Mode' in 'EtherCAT' interface
	- LEARN done?	- Perform LEARN. Refer to 'Pressure control' → 'Adaptive algorithm' → 'Learn'
	- Sensor signal ok?	- Refer to 'Pressure Sensor'
	- Pressure control setup done	- Refer to 'Pressure control'
PRESSURE CONTROL not optimal	- LEARN successfully done?	- Perform LEARN. Check 'Status' and 'Warning Info' in 'Pressure control' → 'Adaptive algorithm' → 'Learn'
	- ZERO performed before LEARN?	- Perform ZERO then repeat LEARN. Refer to 'Pressure Sensor' → 'Zero Adjust'
	- Was gas flow stable during LEARN?	- Repeat LEARN with stable gas flow. Refer to 'Pressure control' → 'Adaptive algorithm' → 'Learn'
	- Tuning done?	- Tune valve for application. Refer to the tuning sections in 'Pressure Control'
	- Is sensor range suited for application?	- Use a sensor with suitable range (controlled pressure should be >3% and < 98% of sensor full scale).
	- Noise on sensor signal?	- Make sure a shielded sensor cable is used.

7 Maintenance

	<p style="text-align: center;">⚠ WARNING</p> <p>Unqualified personnel Inappropriate handling may cause serious injury or property damage. Only qualified personnel are allowed to carry out the described work.</p>
	<p style="text-align: center;">⚠ WARNING</p> <p>Valve opening Risk of serious injury. Human body parts must be kept out of the valve opening and away from moving parts. Disconnect power on controller before doing any work.</p>
	<p style="text-align: center;">⚠ CAUTION</p> <p>Hot valve Heated valve may result in minor or moderate injury. Do not touch valve and heating device during operation. Once heating is switched off (valve and system) await until the valve is cooled down complete before doing any work.</p>
	<p style="text-align: center;">NOTICE</p> <p>Contamination Gate and other parts of the valve must be protected from contamination. Always wear clean room gloves when handling the valve.</p>

7.1 Maintenance intervals

Under clean operating conditions, the valve does not require any maintenance during the specified cycle life. Contamination from the process may influence the function and requires more frequent maintenance.

Before carrying out any maintenance, please contact VAT. It has to be individually decided whether the maintenance can be performed by the customer or has to be carried out by VAT. Please write down the fabrication number of the valve before contact VAT. Refer to chapter «Identification of product» for fabrication number.

7.2 Maintenance procedures

Two maintenance procedures are defined for this valve. This are:

- Replacement of shaft feedthrough seals and valve cleaning. Refer to chapter: «Replacement of rotary feedthrough».
- Replacement of Option board. Refer to chapter: «Replacement of Option board»



Required frequency of cleaning and replacement of seals is depending on process conditions.

VAT can give the following recommendations for preventive maintenance:

Replacement of	unheated ¹⁾	heated ≤ 80 °C ¹⁾	heated > 80 °C ¹⁾
Rotary feedthrough seals	2'000'000 cycles	6 months but max. 2'000'000 cycles	3 months but max. 2'000'000 cycles



¹⁾ Those figures are reference values for clean conditions under various temperatures. These values do not include any impact of the process. Therefore preventive maintenance schedule has finally to be checked for the actual process conditions.



Below pictures are sample pictures. Although there may be different variants of the valve, the assembly procedure stays the same.



ISO-KF with heating









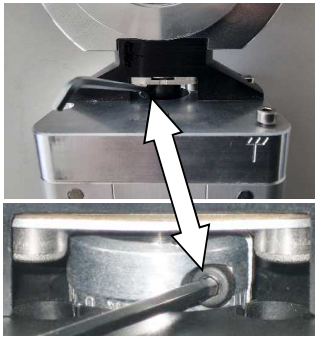

ISO-F

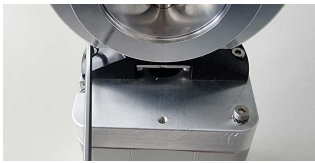

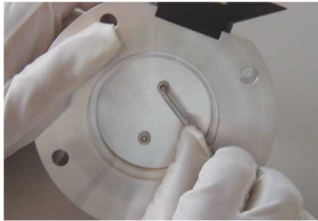
7.2.1 Replacement of shaft feedthrough seals and valve cleaning

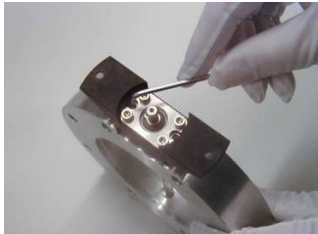

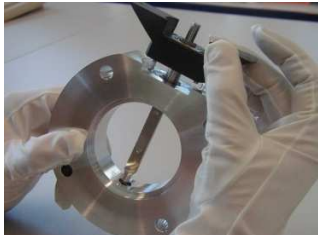
7.2.1.1 Required tools

- Allen Wrench 2 mm / 2.5mm
- Clean room wipes, isopropyl alcohol
- Allen Wrench 3 mm
- Vacuum grease
- Feeler gauge

Description		Required tool
<ol style="list-style-type: none"> 1. Vent vacuum system on both sides of the valve. 2. Make sure the valve is in closed position 3. Disconnect electrical POWER connector at valve and remove valve from vacuum system. 		
 <p>Take care not to damage sealing surface! Do not move the plate by hands when control and actuating unit is installed.</p>		
<ol style="list-style-type: none"> 4. Unfasten clamp coupling 		<p>Allen Wrench: steel coupling 2.5 mm</p>
<ol style="list-style-type: none"> 5. Unfasten the 2 (DN-25-50) or 4 (DN 63-320) connection bolts and separate both parts. <p>Valve size DN 160 (6") and bigger require a shortened wrench. For ordering number refer to «Spare parts and accessories».</p>   <p>12 mm</p>		<p>Allen Wrench 3 mm</p>

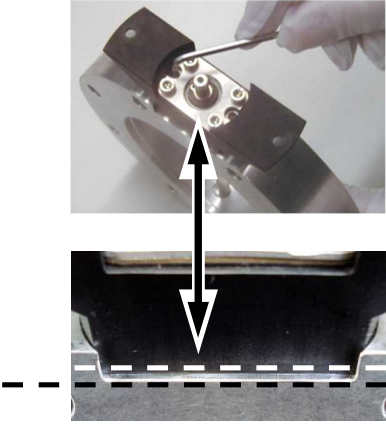
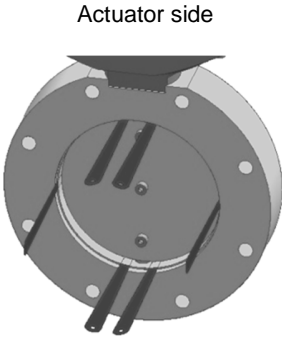
Description		Required tool
<p>6. Unfasten screws and remove plate from shaft.</p>		<p>Allen Wrench 3 mm</p>
<p>7. Unfasten alternately the 2 mounting screws little by little.</p> <p> If only one screw is fasten / unfasten, the mechanical unit will be damaged. Max. difference should be less than 1 turn or 0.5 turn of the screws.</p>	 	<p>Allen Wrench 3 mm</p>
<p>8. Remove mechanical unit and clean shaft.</p>		
<p>9. Remove O-rings. 10. Clean shaft feedthrough and valve body.</p>		<p>Clean room wipes a little soaked with isopropyl alcohol</p>

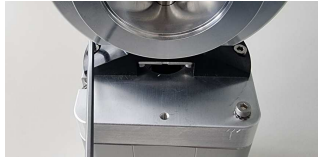
Description		Required tool
11. Lubricate seal contact surface of valve body with a slight film of vacuum grease (0.025 ml). 12. Lubricate each O-ring with a slight film of vacuum grease (0.0125 ml).		
13. Lubricate seal contact surface of shaft with a slight film of vacuum grease (0.0125 ml). 14. Slide both O-rings onto shaft till the end. 15. Deposit 0.0375 ml vacuum grease between the O-rings 16. Clean shaft from vacuum grease.		 <p>Vacuum grease Clean room wipes</p>
17. Assemble mechanical unit in reverse order as disassembled (steps 6 to 5). 18. Align pedestal parallel to valve body and tighten the 2 mounting screws with 2.5 Nm  Make sure the pedestal is aligned to be parallel with the valve body		Allen Wrench 3mm 
19. Center plate.		 <p>Allen Wrench 3 mm Adequate feeler gauge</p>
Size	Feeler gauge mm Unheated AL/ steel body Heated-AL body	
25	0.04 0.06	
40	0.04 0.06	
50	0.04 0.06	
63	0.04 0.06	
80	0.06 0.08	
100	0.06 0.08	
160	0.08 0.10	
200	0.08 0.10	
250	0.10 0.12	
320	0.12 0.14	
20. Tighten plate screws with		
Size	Nm	
25	1.1	
40	2.5	

Description		Required tool
≥ 50	2.5	
21. Assemble control and actuating unit to valve unit. Tighten mounting screws adequately.		Allen Wrench 3mm
22. Tighten clamp coupling: <ul style="list-style-type: none">• with steel coupling 2.2 Nm		Allen Wrench: steel coupling 2.5 mm
23. Reinstall valve into vacuum system according to chapter «Installation».		

7.2.2 Replacement of Option board

	NOTICE
	<p>Electrostatic discharge</p> <p>Electronic components could be damaged.</p> <p>All work on the control and actuating unit has to be done under ESD protected environment to prevent electronic components from damage.</p>

	NOTICE
	<p>Burned connector pins (spark)</p> <p>Connector pins or electronic parts could be damaged, if plugged and unplugged under power.</p> <p>Do not plug or unplug connectors under power.</p>

The option board may or may not be equipped in your valve depending on the order. Refer to page 1 of this manual to check valve version. This board includes the optional modules for the valve which are:

- ± 15 VDC sensor power supply (SPS)
- Power failure option (PFO)

It is available in 3 versions. These are:

- SPS module only
- PFO module only
- SPS and PFO module

The modules may be retrofitted or replaced easily. The battery lifetime of the PFO module depends on the ambient temperature (see below). To assure PFO function the option board must be replaced after battery life has expired. For ordering number of the modules refer to chapter «Spare parts».

7.2.2.1 Durability of power fail battery

The curves in the graph show the estimated life of Ultra Cap PFO in the worst condition (max. sensor load = 1 A, valve heating temperature = 150 °C).

If the SPS is not fully loaded (< 1 A) or heating temperature of valve body is lower than 150 °C, the corresponding life time curve will be somewhere in between the upper and the lower curve.

Therefore please determine the equivalent maintenance period for replacing the Ultra Cap battery (Option board).

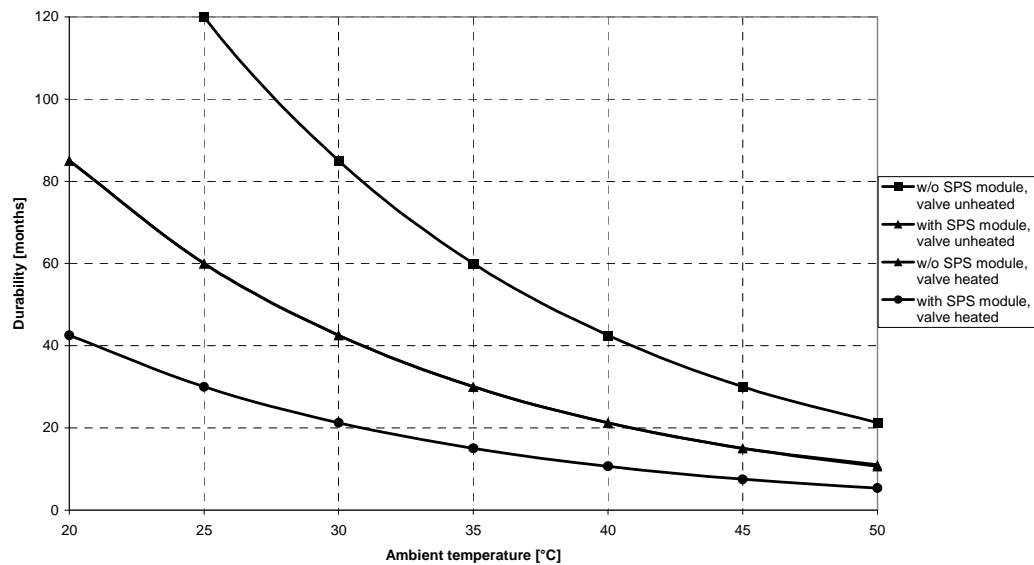

This graph shows estimated life of Ultra Cap PFO for reference and not as guaranteed value.

7.2.2.2 Retrofit / replacement procedure

View on control and actuating unit:

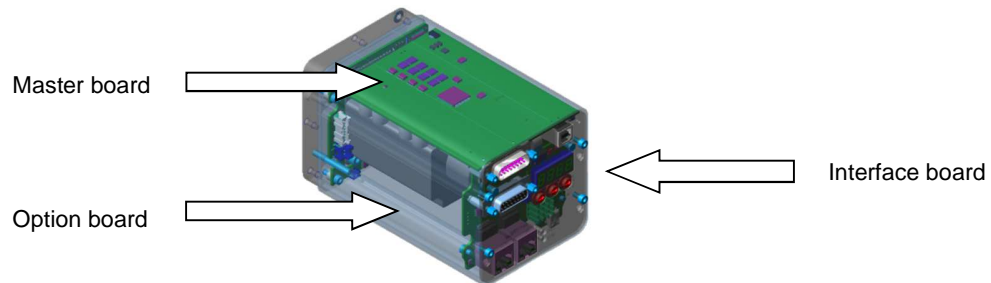







All boards have a fixed position into control and actuating unit. It is not possible to fit a board in other position as shown in picture above! Do not try out other positions, which maybe destroy the socket of boards!





7.2.2.3 Required tools

- Allen Wrench 2 mm / 2.5mm
- Allen Wrench 3 mm

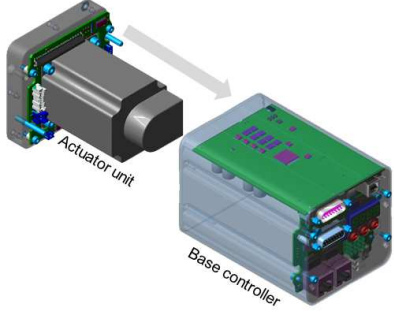

If you need any further information, please contact one of our service centers. You can find the addresses on our website: www.vatvalve.com.

Description		Required tool
 Make sure that the valve is in closed position 1. Vent vacuum system, disconnect electrical connections and remove valve from vacuum system. If you only replace control and actuating unit, the valve can remain in the system.  Take care not to damage sealing surface! Attention! Do not move the plate by hands when control an actuating unit is installed.		Depending on flange screws
2. Unfasten clamp coupling		Allen Wrench: steel coupling 2.5 mm
3. Unfasten the 4 connection bolts and separate both parts.  Valve size DN 160 (6") and bigger require a shortened wrench. For ordering number refer to «Spare parts and accessories». 12 mm 		Allen Wrench 3 mm

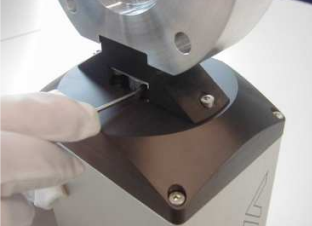
Description		Required tool
<p>4. Replacement of the option board / whole controller</p> <p>Unfasten the two bolts from bottom side and and dismount the controller from the actuator unit.</p> <p>The SPS/PFO option board has to be mounted/ dismounted from bottom side of the controller.</p> <p>The Controller and Interface board are fix connected and shall not be dismantled.</p> <p> you have to work on an ESD-protected working space</p> <p> If you need any further information, please contact one of our service centers. You can find the addresses on our website: www.vatvalve.com</p>		
<p>5. Assemble control and actuating unit to valve unit. Tighten mounting screws adequately.</p>		<p>Allen Wrench: 3mm</p>
<p>6. Tighten clamp coupling:</p> <ul style="list-style-type: none"> • with elastic coupling 1.1 Nm • with steel coupling 2.2 Nm 		<p>Allen Wrench: steel coupling 2.5 mm</p>
<p>7. Reinstall valve into vacuum system according to chapter «Installation».</p>		

8 Repairs

Repairs may only be carried out by the VAT service staff. In exceptional cases, the customer is allowed to carry out the repairs, but only with the prior consent of VAT.

Please contact one of our service centers. You will find the addresses on our website www.vatvalve.com.

8.1 FPR Service

The VAT customer service can refurbish the product or individual components for you. Wear-sensitive parts are replaced, and the guarantee on the replaced parts is extended.

- a) Select the desired Fixed Price Refurbishment service from our comprehensive service program for the refurbishment.
- b) Contact your assigned sales person or the nearest VAT service center to learn about the options for the product in question. www.vatvalve.com.

9 Dismounting and Storage

	⚠ WARNING
	<p>Unqualified personnel Inappropriate handling may cause serious injury or property damage. Only qualified personnel are allowed to carry out the described work.</p>

9.1 Dismounting

	NOTICE
	<p>Contamination Gate and other parts of the valve must be protected from contamination. Always wear clean room gloves when handling the valve.</p>

	NOTICE
	<p>Valve in open position Valve body may become damaged if valve gate is in open position. Move valve gate to the closed position before dismounting the valve.</p>

4. Close the valve
5. For dismounting the valve please follow the instructions of chapter: «Installation», however in reverse order.

9.2 Storage

NOTICE	
	<p>Wrong storage</p> <p>Inappropriate temperatures and humidity may cause damage to the product.</p> <p>Valve must be stored at:</p> <ul style="list-style-type: none">– relative humidity between 10% and 70%– temperature between +10 °C and +50 °C– non-condensing environment

NOTICE	
	<p>Inappropriate packaging</p> <p>Product may get damaged if inappropriate packaging material is used.</p> <p>Always use the original packaging material and handle product with care.</p>

1. Clean / decontaminate valve.
2. Cover all valve openings with a protective foil.
3. Pack valve appropriately, by using the original packaging material.

10 Packaging and Transport

	⚠ WARNING
	<p>Unqualified personnel</p> <p>Inappropriate handling may cause serious injury or property damage. Only qualified personnel are allowed to carry out the described work.</p>

	⚠ WARNING
	<p>Harmful substances</p> <p>Risk of injury in case of contact with harmful substances. Remove harmful substances (e. g. toxic, caustic or microbiological ones) from valve before you return the valve to VAT.</p>

	NOTICE
	<p>Inappropriate packaging</p> <p>Product may get damaged if inappropriate packaging material is used. Always use the original packaging material and handle product with care.</p>



- When returning products to VAT, please fill out the VAT form «Declaration of Chemical Contamination of Vacuum Valves and Components» and send it to VAT in advance. The form can be downloaded from our website www.vatvalve.com (Section: Services – Aftersales).
- If products are radioactively contaminated, the VAT form «Contamination and Radiation Report» must be filled out. Please contact VAT in advance.
- If products are sent to VAT in contaminated condition, VAT will carry out the decontaminating procedure at the customer's expense.

10.1 Packaging

	NOTICE
	<p>Valve in open position Valve mechanism may get damaged if valve is in open position. Make sure that the valve is closed.</p>

1. Cover all valve openings with a protective foil.
2. Pack valve appropriately, by using the original packaging material.



VAT disclaims any liability for damages resulting from inappropriate packaging.

10.2 Transport

	NOTICE
	<p>Inappropriate packaging Product may get damaged if inappropriate packaging material is used. Always use the original packaging material and handle product with care.</p>



VAT disclaims any liability for damages resulting from inappropriate packaging.

11 Disposal

Observe the local regulations for disposal

	WARNING
	<p>Harmful substances Environmental pollution. Discard products and parts according to the local regulations.</p>

	WARNING
	<p>Unqualified personnel Inappropriate handling may cause serious injury or property damage. Only qualified personnel are allowed to carry out the disposal.</p>

	CAUTION
	<p>Risk of damage Indicates a hazardous situation which, if not avoided, may result in minor or moderate injury. A large number of diverse materials are used in the product. Some of them could cause human and machine damage in the case of improper handling.</p> <ul style="list-style-type: none"> • Observe local regulations in regard to waste disposal without fail. • Commission an authorized waste disposal company for the professional disposal of your waste.

	NOTICE
	<p>Improper disposal Some built-in materials can cause damage, if improperly handled. - When disposing, take into account all the different materials used</p>

- | | |
|--|---|
| | <ul style="list-style-type: none"> • Hire an authorised waste disposal company to dispose of the waste in a professional manner. |
|--|---|

The following list should help you to dismantle your product without making serious errors and to properly separate out the product scrap.

Material groups	Hazard level
non-ferrous metals	high
stainless steel	low
aluminum	low
plastics	medium
lubricants	high
electronic scrap	high
batteries	very high
cables and wires	medium
motors	medium
seals and rubber parts	high

12 Spare parts

	NOTICE
	<p>Non-original spare parts</p> <p>Non-original spare parts may cause damage to the product. Use original spare parts from VAT only.</p>



- Please specify the fabrication number of the product when you place an order for spare parts; see chapter: «Identification of product». This is to ensure that the appropriate spare parts are supplied.
- VAT makes a difference between spare parts that may be replaced by the customer and those that need to be replaced by the VAT service staff.
- The following table(s) contain spare parts that may be replaced by the customer. If you need any other spare parts, please contact one of our service centers. You will find the addresses on our website www.vatvalve.com.



For versions such as:

- other valve sizes
- heated valves
- valves made of hard anodized aluminum
- valves made of nickel coated aluminum
- valves made of stainless steel
- valves with JIS, ASA or CF-F flanges

spare parts ordering numbers are available on request.

12.1 ISO-KF for DN 25 – 50 mm

12.1.1 Drawing ISO-KF

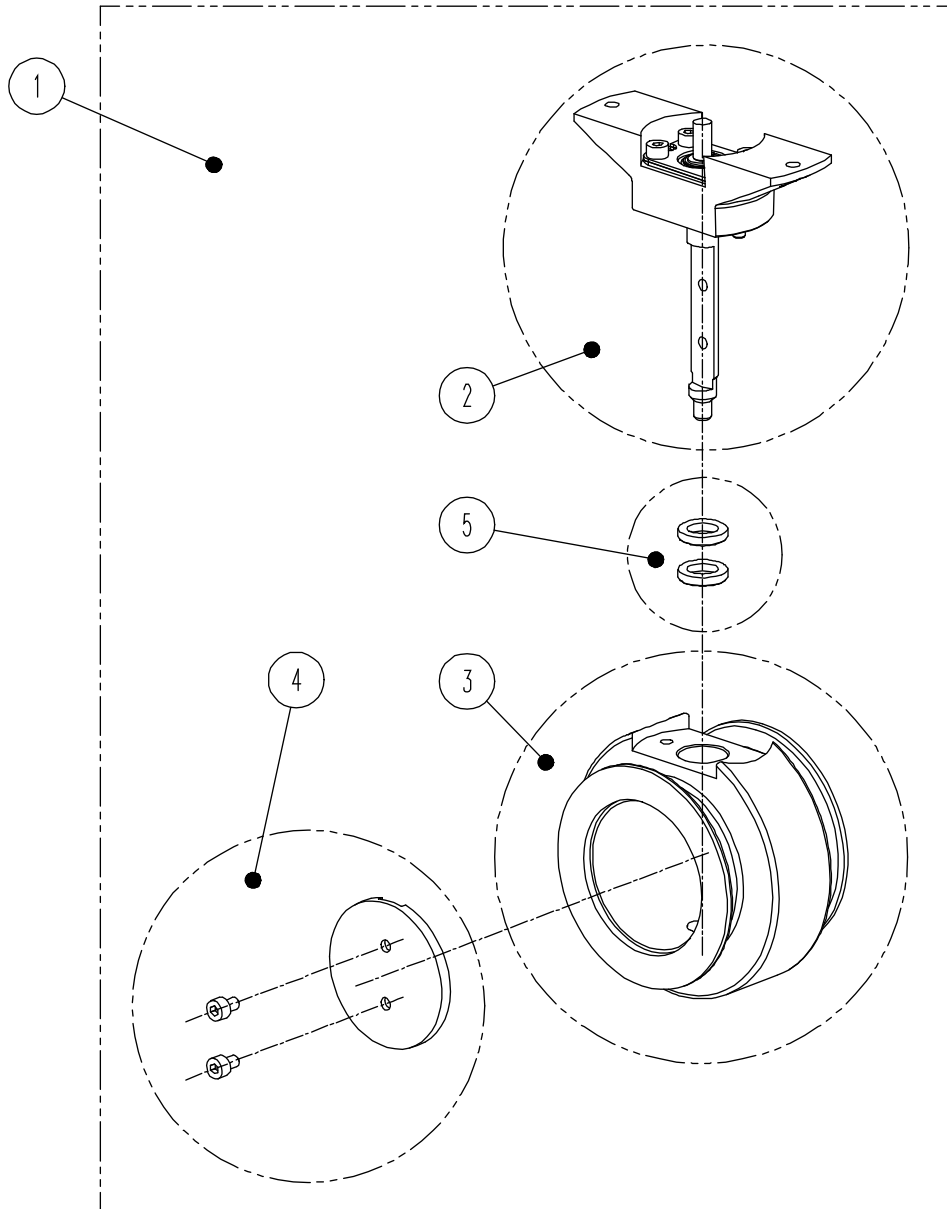

- 1 Body with mechanism
- 2 Shaft kit
- 3 Valve body
- 4 Plate kit
- 5 Shaft feedthrough seals



All "Items in below table" refer to this chapter «Drawing ISO-KF»

12.1.2 ISO-KF valve unit - aluminum blank, without heating

Item	Description			
	Valve size Product ordering number	DN 25 / 1" 61328 - KA . . ISO-KF	DN 40 / 1½" 61332 - KA . . ISO-KF	DN 50 / 2" 61334 - KA . . ISO-KF
1	Spare parts kit valve unit	488956	485726	486738
2	Spare parts kit mechanical unit	488946	471287	471292
3	Spare parts kit valve body	240574	232271	232272
4	Spare parts kit plate	253255	232276	232277
	Plate screws	361960 (2 pcs required)	353386 (2 pcs required)	353386 (2 pcs required)

12.1.3 ISO-KF valve unit – stainless steel, without heating

Item	Description			
	Valve size Product ordering number	DN 25 / 1" 61328 - KE . . ISO-KF	DN 40 / 1½" 61332 - KE . . ISO-KF	DN 50 / 2" 61334 - KE . . ISO-KF
1	Spare parts kit valve unit	489057	486772	485723
2	Spare parts kit mechanical unit	488946	471287	471292
3	Spare parts kit valve body	342558	243089	237850
4	Spare parts kit plate	342563	243090	239549
	Plate screws	361960 (2 pcs required)	353386 (2 pcs required)	353386 (2 pcs required)

12.1.4 Seals and grease

Item	Description		
	Valve size Product ordering number	All sizes 613 . . -	
5	Vacuum seal kit	VITON ®	237235 (2x N-5100-204)
		Others	on request
	Vacuum grease syringe		206792 (2ml), 206793 (5ml)

12.2 ISO-F for DN 63 – 320 mm

12.2.1 Drawing ISO-F

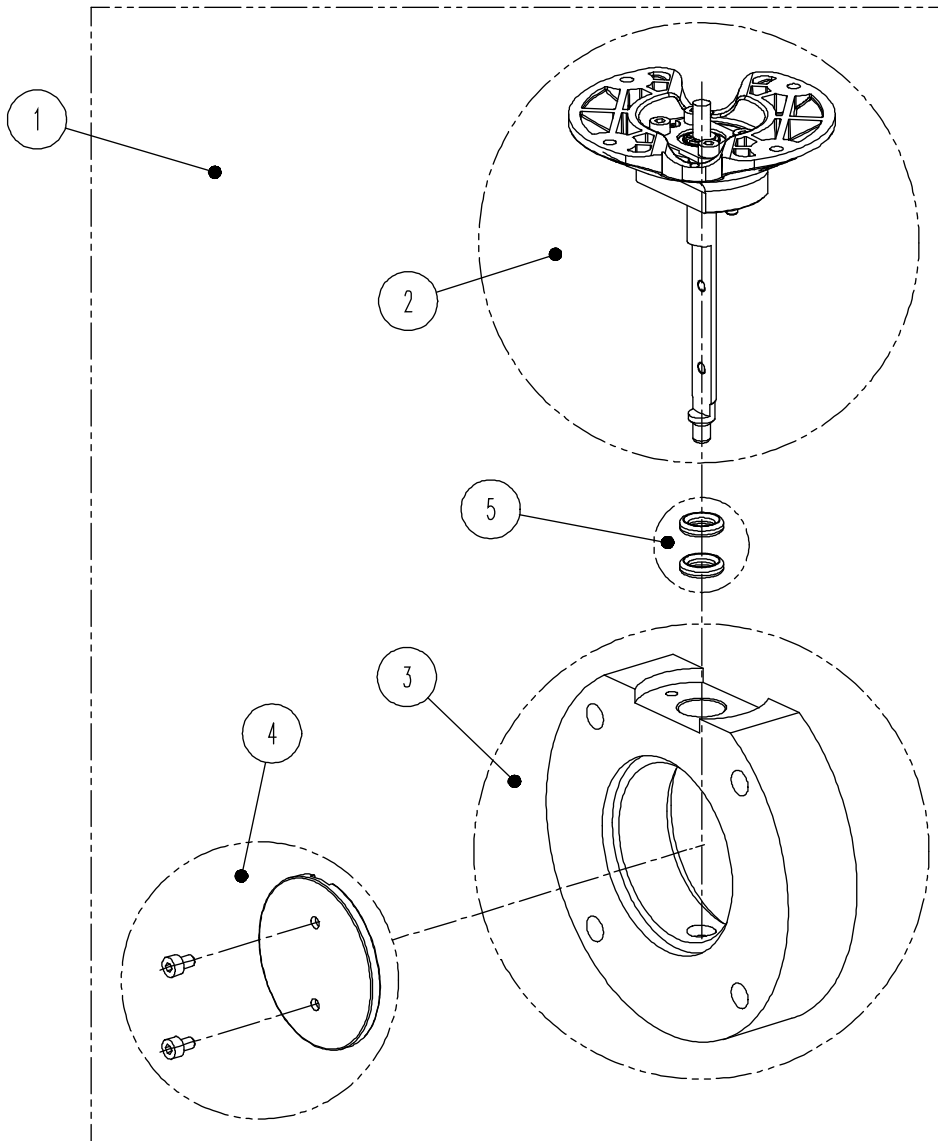

- 1 Body with mechanism
- 2 Shaft kit
- 3 Valve body
- 4 Plate kit
- 5 Shaft feedthrough seals



All "Items in below table" refer to this chapter «Drawing ISO-F»

12.2.2 ISO-F valve unit - aluminum blank, without heating

Item	Description							
	Valve size Product ordering number	DN 63 / 2½"	DN 80 / 3"	DN 100 / 4"	DN 160 / 6"	DN 200 / 8"	DN 250 / 10"	DN 320 / 12"
		61336-PA ..	61338-PA ..	61340-PA ..	61344-PA ..	61346-PA ..	61348-PA ..	61350-PA ..
1	Spare parts kit valve unit	490143	489471	490093	489026	491729	489827	249284
2	Spare parts kit mechanical unit	490144	489464	490094	489022	491728	489910	807298
3	Spare parts kit valve body	232273	232274	232275	243026	237716	241204	327111
4	Spare parts kit plate	232278	232279	232280	243028	237725	252046	327109
	Plate screws	353386 (2 pcs required)	353386 (3 pcs required)	353386 (3 pcs required)	353386 (3 pcs required)	353386 (3 pcs required)	353386 (3 pcs required)	353386 (3 pcs required)

12.2.3 ISO-F valve unit – stainless steel, without heating

Item	Description							
	Valve size Product ordering number	DN 63 / 2½"	DN 80 / 3"	DN 100 / 4"	DN 160 / 6"	DN 200 / 8"	DN 250 / 10"	DN 320 / 12"
		61336-PA ..	61338-PA ..	61340-PA ..	61344-PA ..	61346-PA ..	61348-PA ..	61350-PA ..
1	Spare parts kit valve unit	491837	491711	491749	491978	497131	502651	-
2	Spare parts kit mechanical unit	490144	489464	490094	489022	491728	489910	-
3	Spare parts kit valve body	252748	248433	252764	243026	252778	393073	-
4	Spare parts kit plate	252738	248463	252763	243028	244362	414211	-
	Plate screws	353386 (2 pcs required)	353386 (3 pcs required)	353386 (3 pcs required)	353386 (3 pcs required)	353386 (3 pcs required)	353386 (3 pcs required)	353386 (3 pcs required)

12.2.4 Seals and grease

Item	Description		
	Valve size Product ordering number	All sizes 613 ... -	
5	Vacuum seal kit	VITON®	237235 (2x N-5100-204)
		Others	on request
	Vacuum grease syringe		206792 (2ml), 206793 (5ml)

12.3 Control unit and Accessories

12.3.1 Control and actuating unit

Description	Part number
Control and actuating unit	Too many to list. Please contact VAT.
Option board with SPS module (±15 VDC Sensor Power Supply)	858530
Option board with PFO module (Power Failure Option)	858529
Option board with SPS and PFO module	840512

12.3.2 Accessories

Description	Part number
24 VDC power supply unit (input: 100 – 240 VAC)	891528 (D-Sub15 connector)
Adapter cable for power supply with D-Sub9 connector	(735567) (D-Sub15 to D-Sub9)
Plug D-sub 15 pin female with 4- 40UNC screws for the power input and Logic interface (plug only)	81177-R1
Service cable (PC to valve Service connector)	809474 (USB A–B male-male)
Special Allen wrench (SW3) for disassembly and assembly	244873
O-ring removal tool	234859

12.3.3 Centering ring with VITON® O-ring

Description				
Valve size		DN 25 / 1	DN 40 / 1½"	DN 50 / 2"
Product ordering number		61328 -	61332 -	61334 -
Centering ring with VITON® O-ring (for ISO-KF and ISO- F installation only)	Aluminum	31028-KAZV-0001	31032-KAZV--0001	32034-KAZV-0001
	Stainless steel	31028-KEZV-0001	31032-KEZV-0001	32034-KEZV-0001

This page left blank intentionally.