

## Butterfly Pressure Control Valve with CC Link interface

### Series 613 DN 25-320 mm (I.D. 1" - 12")

This manual is valid for the valve ordering number(s):

<b>613 . . . .GN - . . . .</b>	(2 sensor inputs / analog outputs)
<b>613 . . . .AN - . . . .</b>	(2 sensor inputs / analog outputs / $\pm 15V$ SPS)
<b>613 . . . .HN - . . . .</b>	(2 sensor inputs / analog outputs / PFO)
<b>613 . . . .CN - . . . .</b>	(2 sensor inputs / analog outputs / $\pm 15V$ SPS / PFO)

configured with firmware: **F01.0C.28.xx**

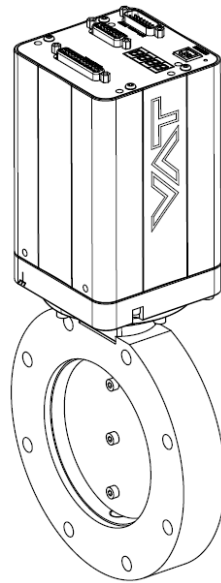

Sample picture

## Imprint

Manufacturer VAT Vakuumventile AG, CH-9469 Haag, Switzerland

Website: [www.vatvalve.com](http://www.vatvalve.com)

Phone: +41 81 771 61 61

Fax: +41 81 771 48 30

Email: [CH@vatvalve.com](mailto:CH@vatvalve.com)

Publisher VAT Vakuumventile AG, CH-9469 Haag, Switzerland

Editor VAT Vakuumventile AG, CH-9469 Haag, Switzerland

Print VAT Vakuumventile AG, CH-9469 Haag, Switzerland

Copyright © VAT Vakuumventile AG 2022

No part of these instructions may be reproduced in any way (photocopies, microfilms or any other reproduction processes) nor may it be manipulated with electronic systems, duplicated or distributed without written permission from VAT. Offenders are liable to pay damages.

The original VAT firmware and updated state of the art versions of the VAT firmware are intended for use with VAT products. The VAT firmware contains a limited, time unlimited user license. The VAT firmware may not be used for purposes other than those intended nor is it permitted to make copies of the VAT firmware. In particular, it is strictly forbidden to give copies of the VAT firmware to other people.

The use of trade names, brand names, trademarks, etc. in these Instructions does not entitle third parties to consider these names to be unprotected and to use them freely. This is in accordance with the meaning of the laws and acts covering brand names and trademarks.

## Contents

<b>1</b>	<b>Description of product.....</b>	<b>6</b>
1.1	Identification of product .....	6
1.2	Firmware .....	6
1.3	Use of product .....	6
1.4	Used abbreviations.....	6
1.5	Related documents.....	6
1.6	Important information.....	6
1.7	Technical data .....	7
1.7.1	Control and actuating unit .....	7
1.7.2	Valve unit .....	7
<b>2</b>	<b>Safety .....</b>	<b>8</b>
2.1	Compulsory reading material.....	8
2.2	Danger levels .....	8
2.3	Personnel qualifications.....	9
2.4	Safety labels .....	9
<b>3</b>	<b>Design and Function.....</b>	<b>10</b>
3.1	Design .....	10
3.2	Function.....	10
3.2.1	Pressure control system overview and function .....	10
3.2.2	Principle of a pressure control system .....	12
<b>4</b>	<b>Installation .....</b>	<b>13</b>
4.1	Initial procedure .....	13
4.2	Unpacking .....	14
4.3	Installation into the system .....	15
4.3.1	Installation Hints.....	16
4.3.2	Installation space condition .....	16
4.3.3	Admissible forces .....	17
4.3.4	Admissible forces at controller .....	18
4.3.5	Tightening torque DN <sub>s</sub> 40 – 50mm .....	19
4.3.6	Tightening torque DN <sub>s</sub> 63 – 100mm .....	20
4.4	Connection overview .....	21
4.5	Power-, Ground- and Sensor Connection.....	22
4.5.1	Connection cable recommendations.....	22
4.5.2	Ground connection.....	23
4.5.3	Power and Sensor supply concepts.....	24
4.5.4	Drive Power Enabled Switch, Safety Mode.....	28
4.6	Power Up.....	29
4.7	Power Down, Power Failure Option .....	29
4.7.1	Power down behavior in case of power failure .....	29
4.7.2	Power Fail Option .....	29
4.8	Service Port, CPA software .....	30
4.8.1	How to start.....	30
4.8.2	Update .....	31
4.9	Display Information.....	32
4.9.1	Power up.....	32
4.9.2	Operation .....	33
4.9.3	Error .....	33
4.10	System Settings and States .....	34
4.10.1	Identification.....	34
4.10.2	Statistics.....	35
4.10.3	Warning/Error.....	36
4.10.4	Service.....	36

4.11	Valve Settings and States.....	37
4.11.1	States .....	37
4.11.2	Homing.....	37
4.11.3	Cycle Counter.....	38
4.11.4	Position Restriction.....	38
4.11.5	Position Adaption .....	39
4.12	Interface CC-Link.....	40
4.12.1	Connection .....	41
4.12.2	LEDs .....	43
4.12.3	Parameters.....	44
4.12.4	Cyclic Data Setting .....	45
4.12.5	Handshaking .....	46
4.12.6	Location of the handshaking bits.....	47
4.12.7	Example of the handshaking by a PLC-program .....	48
4.12.8	Process data – cyclic communication.....	49
4.12.9	OUTPUT Buffer (Master PLC).....	49
4.12.10	INPUT Buffer (Master PLC).....	52
4.13	Pressure Sensor .....	61
4.13.1	Mechanical connection requirements .....	61
4.13.2	Configuration.....	62
4.13.3	Crossover (2 sensor operation mode) .....	64
4.13.4	Zero Adjust.....	65
4.13.5	Logarithmic Pressure .....	66
4.14	Power Connector Digital IO .....	67
4.14.1	Digital Input .....	67
4.14.2	Digital Output.....	68
<b>5</b>	<b>Operation.....</b>	<b>69</b>
5.1	Access Mode .....	70
5.1.1	Overview .....	70
5.1.2	Remote and Locked operation .....	70
5.1.3	Local operation.....	70
5.2	Control Mode .....	71
5.2.1	View .....	72
5.3	Pressure Control.....	73
5.3.1	Controller units .....	73
5.3.2	Control algorithm .....	74
5.3.3	Adaptive algorithm.....	76
5.3.4	PI algorithm .....	87
5.3.5	Pressure Ramp .....	93
5.3.6	Profile Ramp .....	96
5.3.7	Automated Controller Selector .....	99
5.3.8	Control Position Restriction .....	100
5.3.9	Store Control Parameter Volatile.....	100
5.4	Position Control .....	101
5.4.1	Parameter .....	101
5.4.2	Position Ramp.....	101
5.5	Operation under increased temperature .....	102
<b>6</b>	<b>Trouble shooting .....</b>	<b>103</b>
6.1	Warnings .....	103
6.2	Errors.....	105
6.2.1	Error Recovery .....	105
6.2.2	Error Bitmap .....	105
6.2.3	Error Number.....	106
6.2.4	Error Code.....	106
6.3	Troubleshooting List .....	108
<b>7</b>	<b>Maintenance .....</b>	<b>109</b>

7.1	Maintenance intervals.....	109
7.2	Maintenance procedures .....	110
7.2.1	Replacement of shaft feedthrough seals and valve cleaning .....	111
7.2.2	Replacement of Option board .....	115
<b>8</b>	<b>Repairs .....</b>	<b>120</b>
8.1	FPR Service .....	120
<b>9</b>	<b>Dismounting and Storage.....</b>	<b>121</b>
9.1	Dismounting .....	121
9.2	Storage.....	122
<b>10</b>	<b>Packaging and Transport .....</b>	<b>123</b>
10.1	Packaging.....	124
10.2	Transport.....	124
<b>11</b>	<b>Disposal .....</b>	<b>125</b>
<b>12</b>	<b>Spare parts .....</b>	<b>126</b>
12.1	ISO-KF for DN 25 – 50 mm .....	127
12.1.1	Drawing ISO-KF .....	127
12.1.2	ISO-KF valve unit - aluminum blank, without heating.....	128
12.1.3	ISO-KF valve unit – stainless steel, without heating .....	128
12.1.4	Seals and grease .....	128
12.2	ISO-F for DN 63 – 320 mm.....	129
12.2.1	Drawing ISO-F .....	129
12.2.2	ISO-F valve unit - aluminum blank, without heating.....	130
12.2.3	ISO-F valve unit – stainless steel, without heating.....	130
12.2.4	Seals and grease .....	130
12.3	Control unit and Accessories.....	131
12.3.1	Control and actuating unit .....	131
12.3.2	Accessories.....	131
12.3.3	Centering ring with VITON ® O-ring.....	131

# 1 Description of product

## 1.1 Identification of product

The fabrication number and order number are fixed on the product directly or by means of an identification plate.

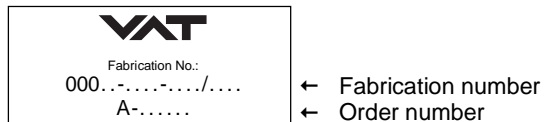

## 1.2 Firmware

Please look up the firmware version in the CPA or read it from the display at start up.  
 Location: CPA/Parameters: System.Identification.Firmware

## 1.3 Use of product

This product is a Butterfly control valve for downstream pressure control in vacuum systems. Use product for clean and dry vacuum applications only. Other applications are only allowed with the written permission of VAT.

## 1.4 Used abbreviations

Abbreviation	Description
CPA	Control Performance Analyzer
PFO	Power Failure Option
SFS	Sensor Full Scale
SPS	Sensor Power Supply
ADC	Analog-to-digital converter

## 1.5 Related documents

- Product Data Sheet
- Dimensional Drawing
- IOMI Heating device (if valve with heater)

## 1.6 Important information



This symbol points to a very important statement that requires particular attention.

### Example:



Refer to chapter: «Technical data» for detailed information.

## 1.7 Technical data

### 1.7.1 Control and actuating unit



See product data sheet.

### 1.7.2 Valve unit



See product data sheet.

## 2 Safety

### 2.1 Compulsory reading material

Read this chapter prior to performing any work with or on the product. It contains important information that is significant for your own personal safety. This chapter must have been read and understood by all persons who perform any kind of work with or on the product during any stage of its serviceable life.

	NOTICE
	<p><b>Lack of knowledge</b> Failing to read this manual may result in property damage. Firstly, read manual.</p>



These Installation, Operating & Maintenance Instructions are an integral part of a comprehensive documentation belonging to a complete technical system. They must be stored together with the other documentation and accessible for anybody who is authorized to work with the system at any time.

### 2.2 Danger levels

	⚠ DANGER
	<p><b>High risk</b> Indicates a hazardous situation, which if not avoided, will result in death or serious injury.</p>



	⚠ WARNING
	<p><b>Medium risk</b> Indicates a hazardous situation, which if not avoided, could result in death or serious injury.</p>

	⚠ CAUTION
	<p><b>Low risk</b> Indicates a hazardous situation, which if not avoided, may result in minor or moderate injury.</p>

	NOTICE
	<p><b>Command</b> Indicates a hazardous situation, which if not avoided, may result in property damage.</p>



## 2.3 Personnel qualifications

	 <b>WARNING</b>
	<b>Unqualified personnel</b> Inappropriate handling may cause serious injury or property damage. Only qualified personnel are allowed to carry out the described work.

## 2.4 Safety labels

Label	Part No.	Location on valve
	T-9001-156	On protective foil covering of valve opening

## 3 Design and Function

### 3.1 Design

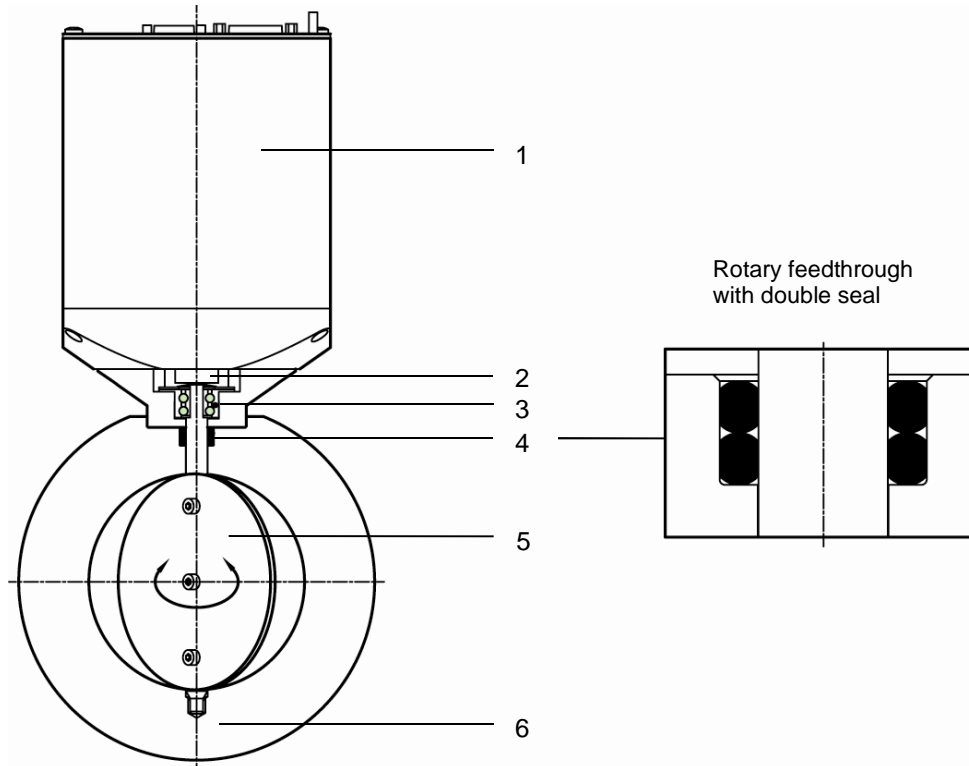

- |   |                       |   |             |
|---|-----------------------|---|-------------|
| 1 | Integrated controller | 4 | Double seal |
| 2 | Coupling              | 5 | Plate       |
| 3 | Bearing               | 6 | Valve body  |

### 3.2 Function

The valve plate (5) acts as a throttling element and varies the conductance of the valve opening. The integrated controller (1) calculates the required plate position to achieve the setpoint pressure. See also principle drawing on chapter: «Connection Overview». Actuation is handled by a stepper motor with an encoder monitoring the position. This principle ensures very fast and accurate process pressure control even in demanding contaminating processes.

#### 3.2.1 Pressure control system overview and function

Vacuum pressures are always absolute pressures unless explicitly specified as pressure differences.

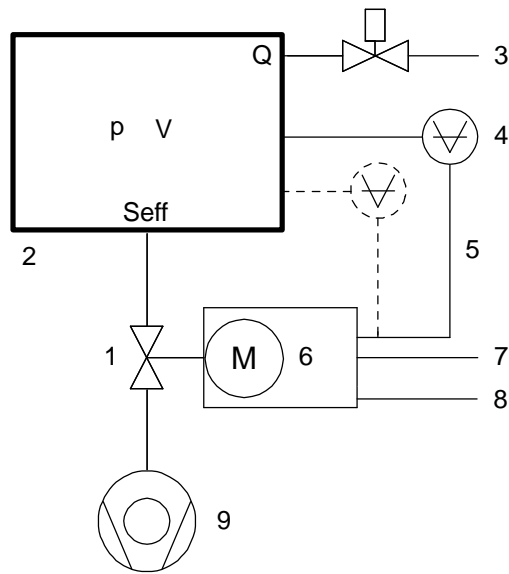

- 1 Valve
- 2 Process chamber
- 3 Gas inlet
- 4 Pressure sensor(s)
- 5 Sensor cable
- 6 Controller and actuator
- 7 Cable to remote control unit
- 8 Cable to power supply
- 9 HV Pump

$S_{eff} = Q / p$   
 $S_{eff}$  effective pump speed (l/s)  
 Q Gas flow (mbar)  
 p Pressure (mbar)

or units used in USA

$S_{eff} = 12.7 \cdot Q / p$   
 $S_{eff}$  effective pump speed (l/s)  
 Q Gas flow (sccm)  
 p Pressure (mTorr)

Example: Downstream control

### 3.2.1.1 Way of operation

The controller compares the actual pressure in the process chamber given by the pressure sensor with the preset pressure. The controller uses the difference between actual and set pressure to calculate the correct position of the control valve. The controller drives the control valve into the correct position and the actual pressure again equals the set pressure.

This control operation is performed continuously. Pressure changes in the process chamber due to leaks, desorption, and gas flow, reaction products, variations in pumping speed etc. are always corrected at once.

### 3.2.1.2 Pressure control

In a vacuum system which is pumped and into which gas is admitted at the same time, the pressure can be controlled in two ways:

1. Downstream control (standard):  
The pressure is controlled by changing the conductance of a control valve between pump and process chamber. This changes the effective pumping speed at the process chamber. Pressure and gas flow can be independently controlled over a wide range.
2. Upstream control:  
The pressure is controlled by changing the gas flow into the process chamber, while the pumping speed remains constant.

### 3.2.1.3 Adaptive controller (standard)

A controller adapting itself to changes in pressure, gas flow and pumping speed without any manual adjustments. This allows for a completely automatic operation of the system.

## 3.2.2 Principle of a pressure control system

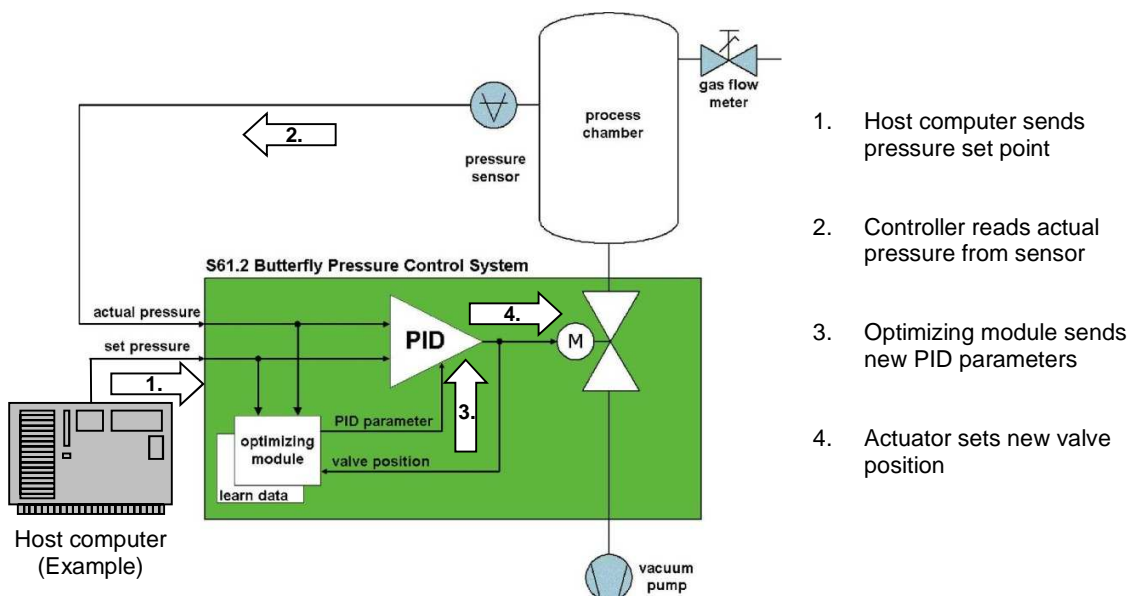

## 4 Installation

	<b>⚠ WARNING</b>
	<p><b>Unqualified personnel</b>                  Inappropriate handling may cause serious injury or property damage.                  Only qualified personnel are allowed to carry out the described work.</p>

### 4.1 Initial procedure

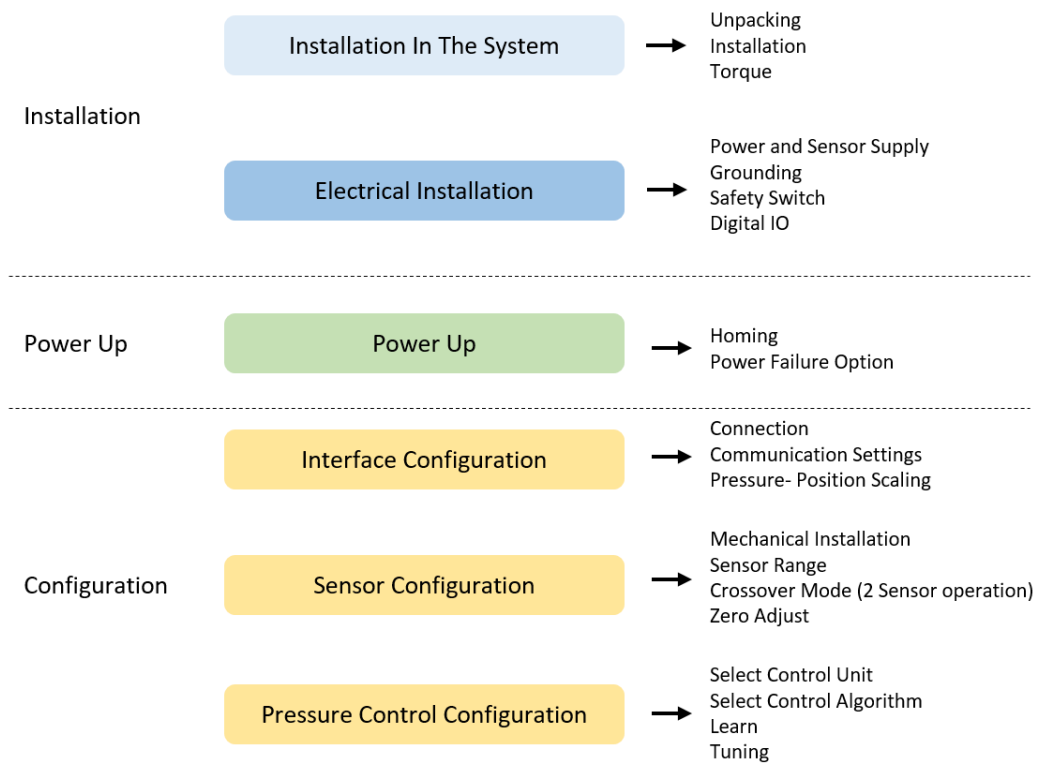

## 4.2 Unpacking

	<b>NOTICE</b>
	<p><b>Physical overstraining at controller</b> Inappropriate handling with the valve may cause in damage of controller. Do not place the valve on the controller.</p>

	<b>NOTICE</b>
	<p><b>Physical overstraining at pedestal</b> Inappropriate handling with the valve may cause in damage of pedestal. Lift valve at valve body out of transport case.</p>



- Make sure that the supplied products are in accordance with your order.
- Inspect the quality of the supplied products visually. If it does not meet your requirements, please contact VAT immediately.
- Store the original packaging material. It may be useful if products must be returned to VAT.

1. Open the transport case and remove inside packing material as far as necessary.
2. Lift the valve carefully and place it on a clean place.





Do not remove protective foils from valve opening

### 4.3 Installation into the system

	<b>⚠ WARNING</b>
	<p><b>Valve opening</b> Risk of serious injury. Human body parts must be kept out of the valve opening and away from moving parts. Do not connect the controller to power before the valve is installed complete into the system.</p>

	<b>NOTICE</b>
	<p><b>Sealing surfaces</b> Sealing surfaces of valve and vacuum system could be damage in case of incorrect handling. Only qualified personal are allowed to install the valve into the vacuum system.</p>

	<b>NOTICE</b>
	<p><b>Wrong connection</b> Wrong connection may result in damage of controller or power supply. Connect all cables exactly as shown in the following descriptions and schematics.</p>

	<b>NOTICE</b>
	<p><b>Burned connector pins (spark)</b> Connector pins or electronic parts could damage, if plugged and unplugged under power. Do not plug or unplug connectors under power.</p>

	<b>NOTICE</b>
	<p><b>Contamination</b> Gate and other parts of the valve must be protected from contamination. Always wear clean room gloves when handling the valve.</p>

 Mount valve to a clean system only.

### 4.3.1 Installation Hints

Install valve into the vacuum system. Valve seat side shall face process chamber.



- Do not tighten the flange screws stronger than indicated under chapter «Tightening torque».
- Do not admit higher forces to the valve than indicated under chapter «Admissible forces».
- Make sure that enough space is kept free to do preventive maintenance work. The required space is indicated on the dimensional drawing.
- Control unit of valves with ISO-KF (61. . . – K . . .) needs support when mounted on horizontal piping and control unit does not hang.

### 4.3.2 Installation space condition



Install the valve with integrated controller with space for dismantling and air circulation as shown in figure below.

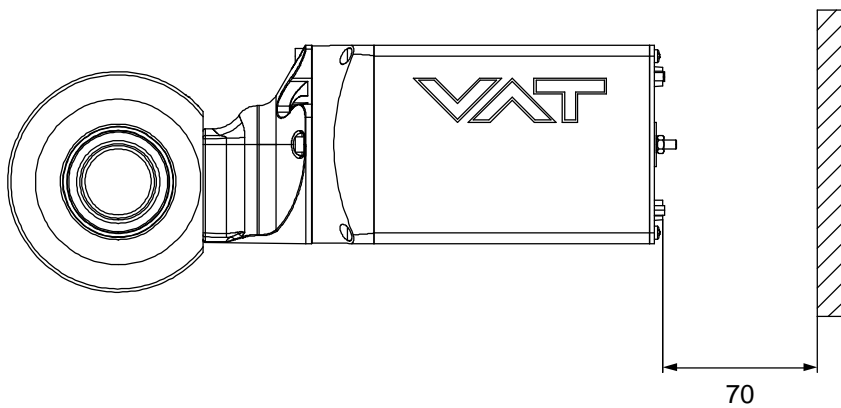

Sample picture



4.3.3 Admissible forces

	<b>NOTICE</b>
	<p><b>Force at valve body</b></p> <p>Forces from the weight of other components can lead to deformation of the valve body and to malfunction of the valve.</p> <p>Do not higher force the valve body as specified.</p>

The following forces are admissible.

Valve size		Axial tensile or compressive force «F <sub>A</sub> »		Bending moment «M»		
mm	inch	N	lb.	Nm	lbf.	
40	1½	100	22	6	4.5	<p>Sample picture</p>
50	2	150	34	11	8	
63	2½	800	176	32	24	<p>sample picture</p>
80	3	850	187	35	26.5	
100	4	1000	220	40	30	

4.3.4 Admissible forces at controller

	<b>NOTICE</b>
	<p><b>Force at pedestal</b></p> <p>In case higher force is applied, the pedestal could be permanently damaged.</p> <ul style="list-style-type: none"> <li>- Do not pushing, shocking load, or stressing the valve controller</li> <li>- Do not deposit anything at valve controller</li> </ul>



The admissible force at valve controller in regards to the pedestal is shown in table below

Admissible force «F»	Overview F = Force a = middle of aluminum part of controller (b / 2)
400 N	<p style="text-align: center;">sample pictures</p>

### 4.3.5 Tightening torque DN40 – 50mm

Tightening torques for ISO-KF flange connections depend on the type of seal which is used. Follow recommendations of seal manufacturer.

#### 4.3.5.1 ISO-KF Clamping connections

Clamping chain (example)

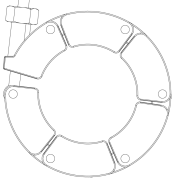
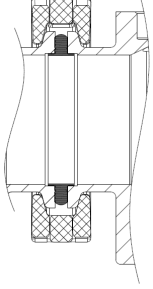
Valve size	ISO-KF	ISO-KF		
	recommended tightening torque (Nm)	recommended tightening torque (lbs . ft)		
DN40 / 1½ "	5	3.7	e.g.: 31032-KASA-0001 31034-KASA-0001	
DN50 / 2"	6	4.5		

Clamping device (example)

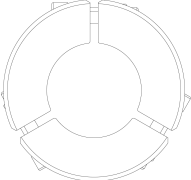
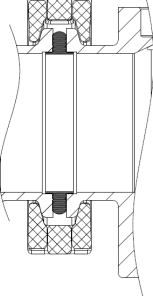
Valve size	ISO-KF	ISO-KF		
	recommended tightening torque (Nm)	recommended tightening torque (lbs . ft)		
DN40 / 1½ "	12	9	e.g.: 31032-KASE-0001 31034-KASE-0001	
DN50 / 2"	12	9		

**4.3.6 Tightening torque DN63 – 100mm**

Tighten mounting screws of the flanges uniformly in crosswise order. Observe the maximum torque levels in the following table. Higher tightening torques deforms the valve body and may lead to malfunction of the valve.

**4.3.6.1 Mounting of CF-F flanges**

Tightening torques for CF-F flange connections depend on the type of seal which is used. Follow recommendations of seal manufacturer.

**4.3.6.2 Mounting with centering rings**

Valve size	ISO-F	ISO-F
	max. tightening torque (Nm)	max. tightening torque (lbs . ft)
DN63 / 2½ “	8-10	6-8
DN80 / 3“	8-10	6-8
DN100 / 4“	8-10	6-8
	hole depth (mm)	hole depth (inch)
DN63 / 2½ “	12	0.47
DN80 / 3“	12	0.47
DN100 / 4“	12	0.47

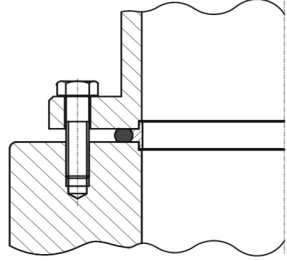

Refer to «Spare parts / Accessories» for centering rings ordering numbers.

**4.3.6.3 Mounting with O-ring in grooves**

Valve size	ISO-F	JIS	ASA-LP	ISO-F	JIS	ASA-LP
	max. tightening torque (Nm)			max. tightening torque (lbs . ft)		
DN63 / 2½ “	20-23	35-40	35-40	15-17	26-30	26-30
DN80 / 3“	20-23	35-40	35-40	15-17	26-30	26-30
DN100 / 4“	20-23	35-40	35-40	15-17	26-30	26-30
	hole depth (mm)			hole depth (inch)		
DN63 / 2½ “	12	n/a	n/a	0.47	n/a	n/a
DN80 / 3“	12	n/a	n/a	0.47	n/a	n/a
DN100 / 4“	12	n/a	n/a	0.47	n/a </td <td>n/a</td>	n/a

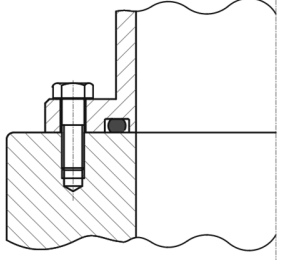



Make sure that screws in use are capable to withstand applied torques.

## 4.4 Connection overview

### Controller IC2-H3:

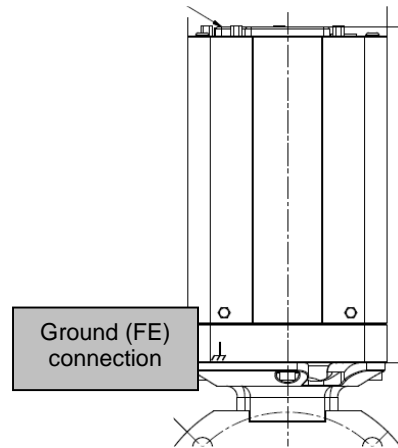
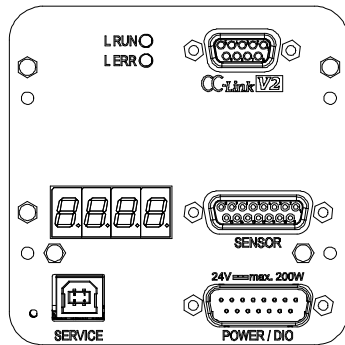
CC-Link



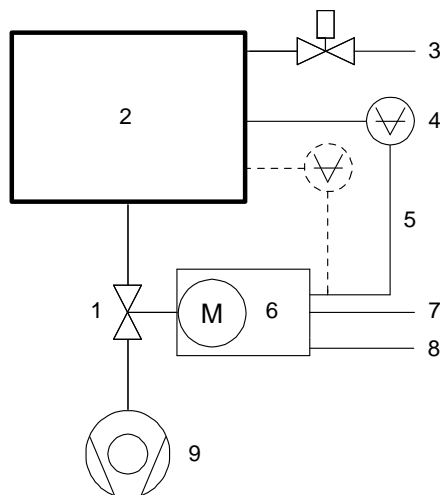

### System:



- 1 Valve
- 2 Process chamber
- 3 Gas inlet
- 4 Pressure sensor(s)
- 5 Sensor cable(s)
- 6 Controller and actuator
- 7 Cable to remote control unit
- 8 Cable to power supply
- 9 Pump

## 4.5 Power-, Ground- and Sensor Connection

	NOTICE
	<p><b>Wrong connection</b></p> <p>Wrong connection may result in damage of controller or power supply. Connect all cables exactly as shown in the following descriptions and schematics.</p>

	NOTICE
	<p><b>Burned connector pins (spark)</b></p> <p>Connector pins or electronic parts could damage, if plugged and unplugged under power. Do not plug or unplug connectors under power.</p>

### 4.5.1 Connection cable recommendations

For Power Supply connection cables, VAT recommends:

Class (min.)	L (Length max.)	d (diameter)
AWG18 (shielded)	5 m	0.823 mm <sup>2</sup>

For Sensor & Signal connection cables, VAT recommends:

Class (min.)	L (Length max.)	d (diameter)
AWG22 (shielded)	20 m	0.326 mm <sup>2</sup>

#### 4.5.2 Ground connection

Recommendation for ground connection between controller and system chassis with cable or with ground strap.

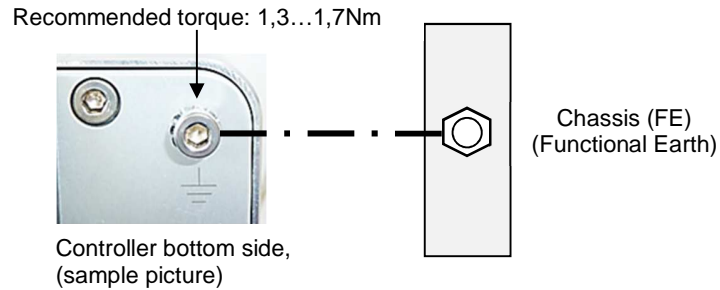

- Recommendation for ground connection cable: AWG 12 (4 mm<sup>2</sup>)
- The connection point at chassis (FE) must be blank metal (not coated).

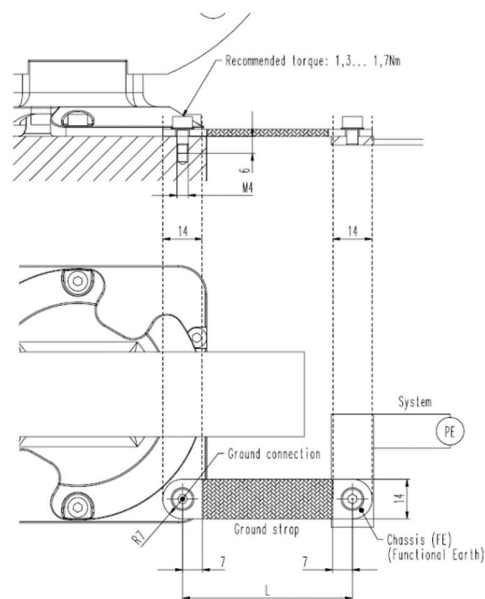

- Connection plates of ground strap must be total plane for a good electrical contact!
- The connection point at chassis (FE) must be blank metal (not coated). It is also possible to connect the ground strap at system chamber if it is well connected to PE.
- Avoid low chassis cross section to the system PE connection. (min. same cross section as ground strap)

### 4.5.3 Power and Sensor supply concepts

This valve offers 3 alternative concepts to supply the sensor(s) with power. This depends on the sensor type and valve version that is used.

Concepts:

**24 VDC sensors:**

- External +24 VDC supplied to POWER connector is feedthrough to SENSOR connector. Refer to chapter «Power and sensor connection (+24 VDC sensors) ».

**±15 VDC sensors:**

- External ±15 VDC supplied to POWER connector is feedthrough to SENSOR connector. Refer to chapter «Power and sensor connection (±15 VDC sensors) without optional SPS module».
- External +24 VDC supplied to POWER connector is converted into ±15 VDC by the valve internal SPS and supplied to SENSOR connector. Refer to chapter «Power and sensor connection (±15 VDC sensors) with optional SPS module».



This concept is only possible when Sensor Power Supply (SPS) option is installed.

For max load consumption, refer to chapter «Technical Data – Control and actuating unit».

Valve versions:

- 61...-... **G** .-... / 61...-... **T** .-... / 61...-... **H** .-...      SPS module not included
- 61...-... **A** .-... / 61...-... **C** .-...      SPS module included



The SPS module can be retrofitted.  
Refer to chapter Retrofit / replacement procedure for instruction.



4.5.3.1 Power and 24V sensor connection

[61... - - G . - - - - / 61... - - - H . - - - - versions recommended]

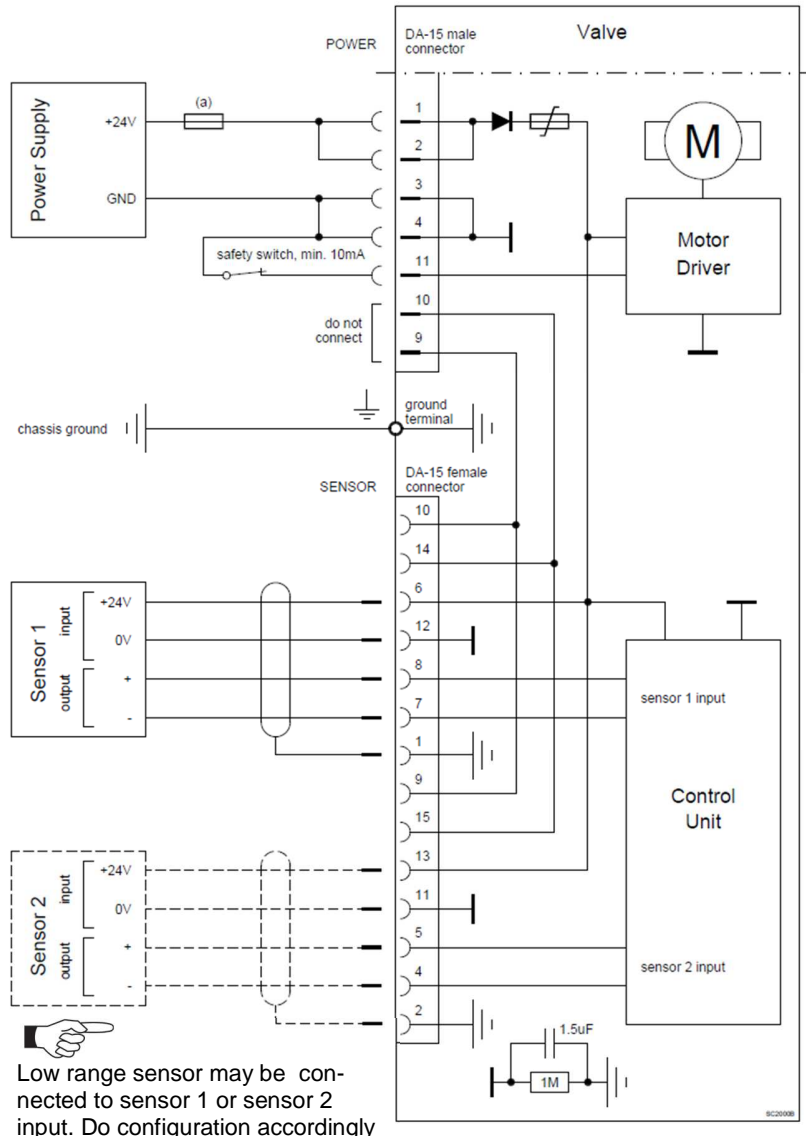

Pins 4 and 11 must be bridged for operation. An optional switch would allow for motor interlock to prevent valve from moving.

Low range sensor may be connected to sensor 1 or sensor 2 input. Do configuration accordingly

- VAT fuse recommendation: (a) 3 AF
- Use shielded sensor cable(s). Keep cable as short as possible, but locate it away from noise sources.
- Connector: Use only screws with 4–40 UNC thread for fastening the connectors!

4.5.3.2 Power and 15V sensor connection

[61...G / 61...H versions recommended]

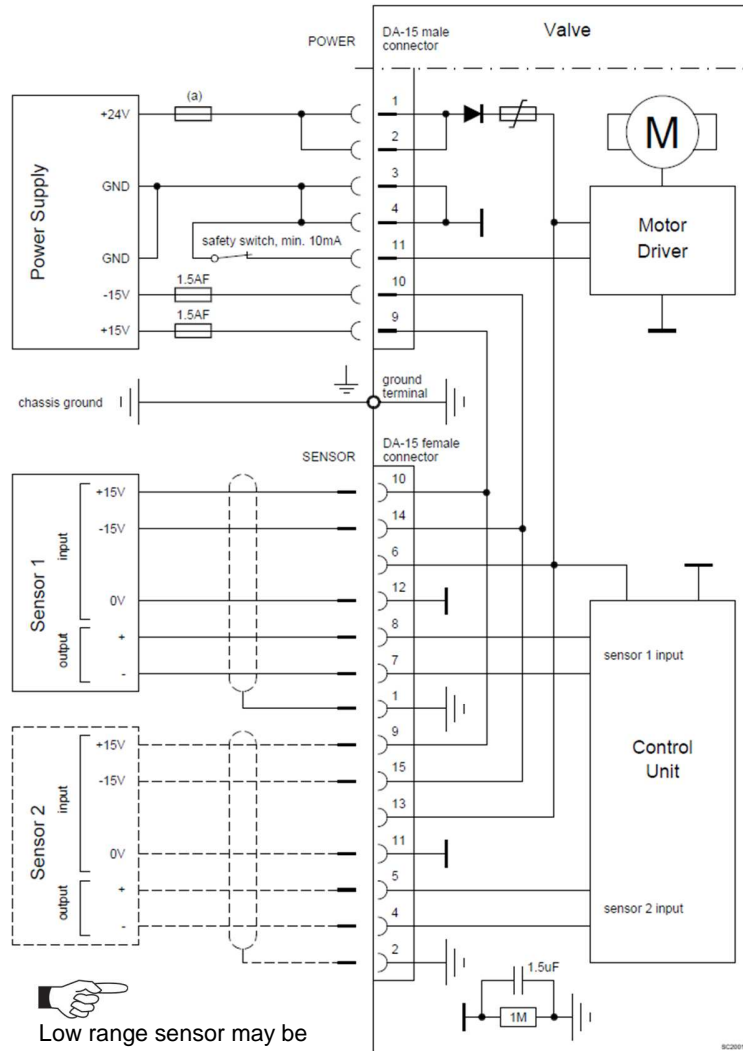

Pins 4 and 11 must be bridged for operation. An optional switch would allow for motor interlock to prevent valve from moving.

Low range sensor may be connected to sensor 1 or sensor 2 input. Do configuration accordingly.

- VAT fuse recommendation: (a) 3 AF**
- Use shielded sensor cable(s). Keep cable as short as possible, but locate it away from noise sources.
- Connector: Use only screws with 4–40 UNC thread for fastening the connectors!

4.5.3.3 Power and 15V sensor connection with optional SPS module

[61... A... / 61... C... versions only]

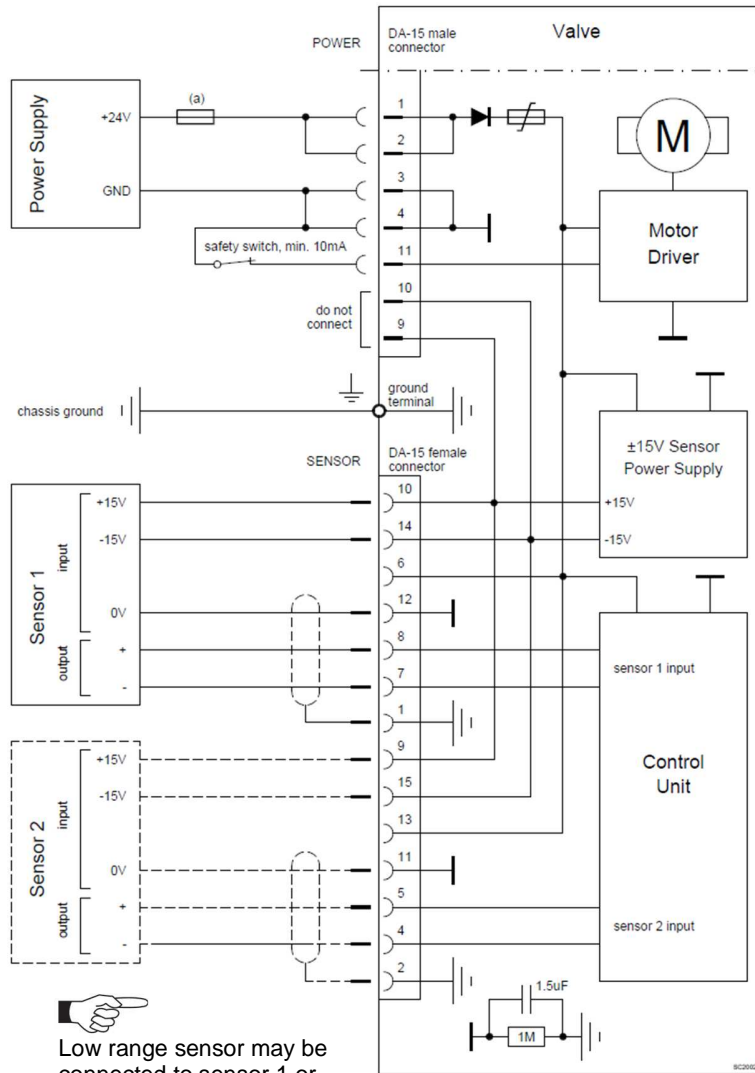

Pins 4 and 11 must be bridged for operation. An optional switch would allow for motor interlock to prevent valve from moving.

Low range sensor may be connected to sensor 1 or sensor 2 input. Do configuration accordingly.

- VAT fuse recommendation: (a) 3 AF
- Use shielded sensor cable(s). Keep cable as short as possible, but locate it away from noise sources.
- Connector: Use only screws with 4–40 UNC thread for fastening the connectors!

#### 4.5.4 Drive Power Enabled Switch, Safety Mode

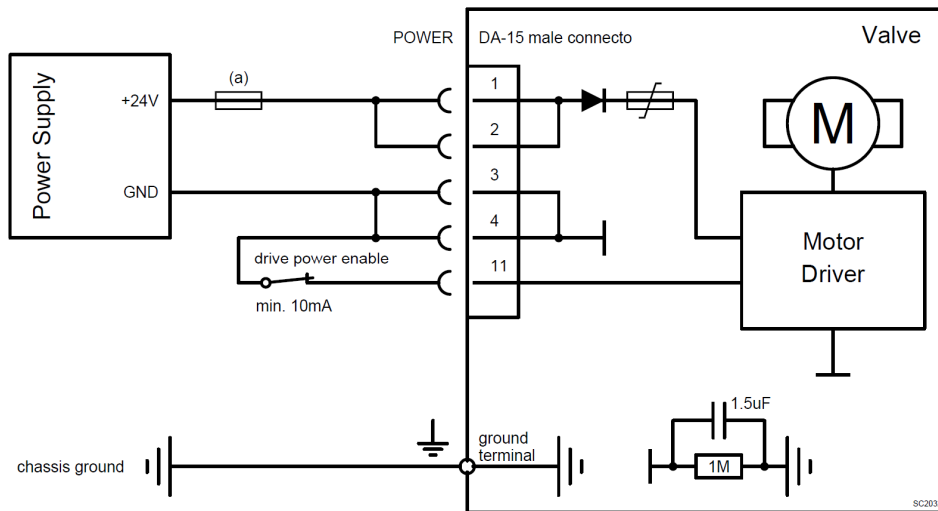

- By means of an external switch the motor power supply can be interrupted.
- In this case the valve enters the 'safety mode'.
- This motor interlock prevents the valve from moving (e.g. maintenance work).
- Data reading from the control unit remains possible.
- When motor interlock is active during power up, the valve directly enters the 'safety mode' and is not able to do homing.
- When 'safety mode' is entered from operation (i.e. pressure control mode), the unit will automatically switch to safety control mode and remain at current position. Once motor interlock is deactivated the valve go to control mode 'Init', so a homing is necessary and will carried out depending on 'Homing' setting (Refer to 'Power Up, Homing')



For safety function without human risk it is recommend using interlock function of the digital inputs, because no new homing is necessary after release of the interlock. Refer to 'Power connector IO' >> 'Digital Input'

## 4.6 Power Up

After power up or possibly after a reset of the valve homing is necessary to determine the plate position.  
Refer to chapter «4.11.2 Homing»

## 4.7 Power Down, Power Failure Option

### 4.7.1 Power down behavior in case of power failure

Valve position before power failure:	Reaction of valve:
Closed (isolated)	Valve remains closed.
Valve open or in any intermediate position	The plate remains at the current position.



All parameters are stored in a power fail save memory.

### 4.7.2 Power Fail Option

Power Fail Option is circuit board that can store as much energy to close or open the valve in the event of a power failure.

Technical data

Charging Time	2 minutes max.
Durability	Up to 10 years @ 25°C ambient

These settings define what the valve is doing in case the power fails.



Valve must be equipped with the 'Power Failure Option'  
[61. . . . . C . . . . . or 61. . . . . H . . . . .]  
For PFO retrofit and other options refer to chapter: «Spare parts».

*Location: CPA/Navigation/Parameters: Power Fail Option*

Parameter	Description
<b>Enable</b>	'True' enables the power fail reaction. 'False' there is no reaction on a power fail
<b>State</b>	<i>Battery is Charging</i> <i>Ready to Use</i> <i>Active</i> <i>Failure</i>
<b>Functionality</b>	<i>Open</i> <i>Close</i>
<b>Delay</b>	In seconds After this delay, the power failure reaction starts after the power failed. Helps to bridge a short power interruption.
<b>Battery Voltage</b>	Shows state of charge
<b>Power Fail Cycles</b>	Counts Power Failure

## 4.8 Service Port, CPA software

The 'Service port is designed for 'Local operation' with the software CPA - Control Performance Analyzer.

Note: Detailed help on the CPA is available in the help of the CPA itself.

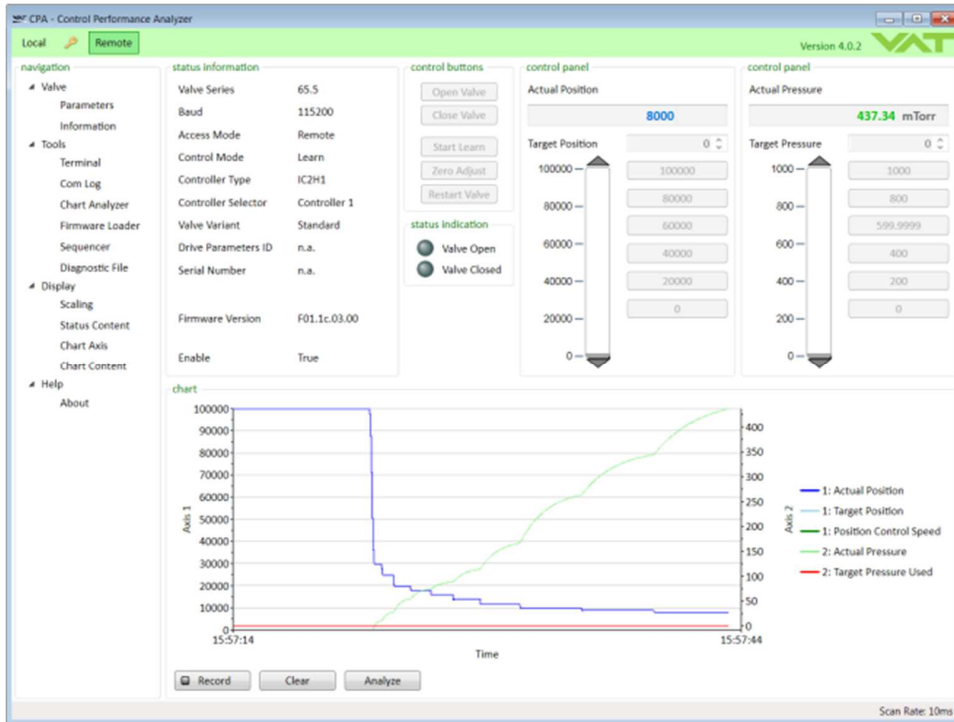

### 4.8.1 How to start

1. Connect service cable (USB A-B cable male-male) between PC and valve:

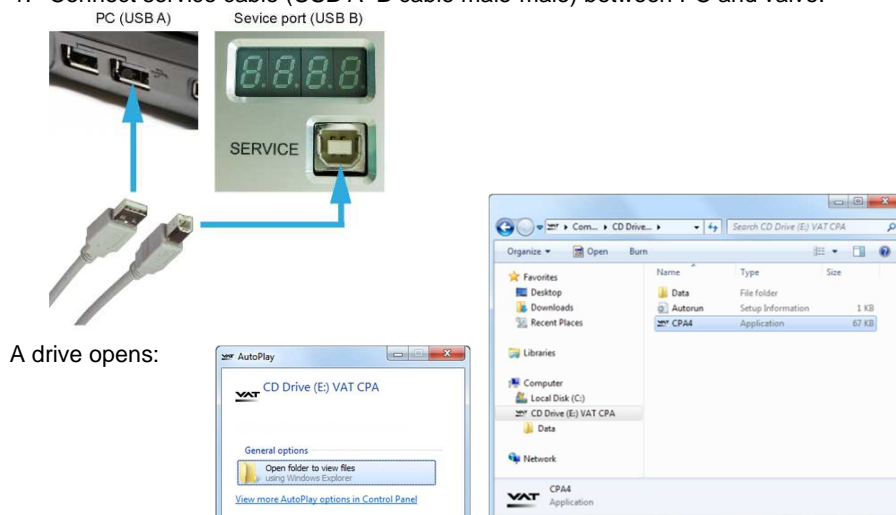

2. Double Click on 'CPA4.exe' to open the 'Control Performance Analyzer'

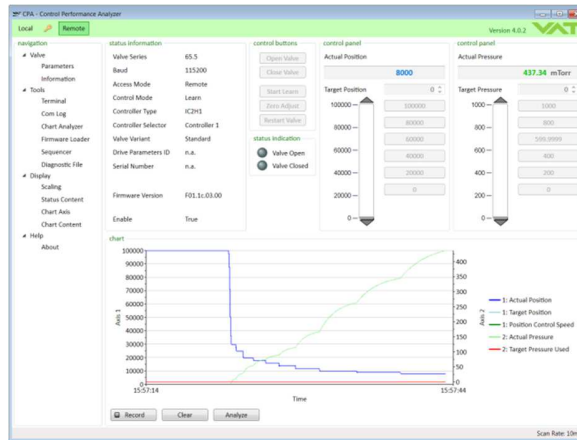

3. Click [Local] for Local operation to do configuration



When communication to service port is interrupted, the valve will change to remote operation. So when service cable will be disconnected or software will be shut down, the valve returns automatically to remote operation. This may result in an **immediate movement** of the valve depending on remote control.

#### 4.8.2 Update

It is easy to update to the latest version of the CPA which can be found on the VAT homepage: <https://www.vatvalve.com/downloads/software>

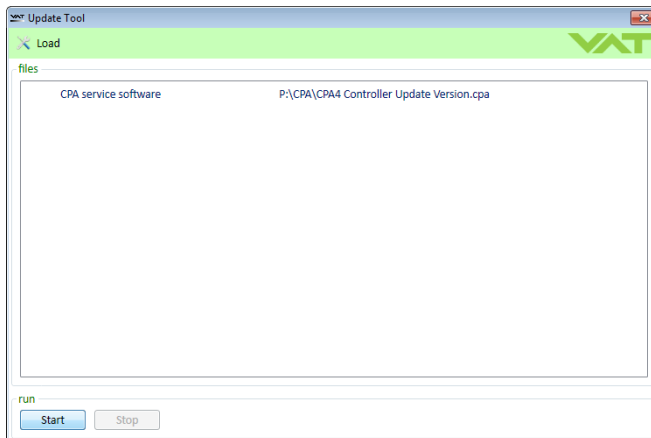

## 4.9 Display Information

There is a 4 digit display located on the controller. It displays configuration, status and position information. For details refer to following tables.

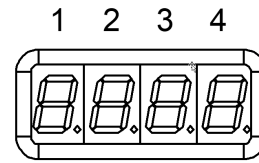

### 4.9.1 Power up

Description	Digit 1	Digit 2	Digit 3	Digit 4
<ul style="list-style-type: none"> <li>1<sup>st</sup> Power On: All dots are illuminated</li> </ul>	#	#	#	#
<ul style="list-style-type: none"> <li>2<sup>nd</sup> Valve series e.g. <b>67.0</b></li> </ul>		6	7	0
<ul style="list-style-type: none"> <li>3<sup>rd</sup> Firmware: generation.type e.g. <b>01.0C</b></li> </ul>	0	1	0	C
<ul style="list-style-type: none"> <li>4<sup>th</sup> Firmware: version.firmware e.g. <b>07.00</b></li> </ul>	0	7	0	0
<ul style="list-style-type: none"> <li>5<sup>th</sup> Controller configuration: e.g. <b>11.00</b></li> </ul>	<b>Controller</b> 1=H1 2=H2 3=H3 4=H4 5=H5 6=H6 7=H7	<b>Interface</b> 1=RS232/RS485 2=EtherCAT 3=DeviceNet 5=Logic 7=Profibus 8=CCLink 9=EtherNet	<b>Options</b> 00=none 01=SPS 02=PFO 03=Cluster 04=SPS + PFO 05=SPS + Cluster 06=PFO + Cluster 07=SPS + PFO & Cluster 08=PFO2 09=SPS + PFO2 0A=PFO2 + Cluster 0B=SPS + PFO2 + Cluster 0C=PFO3 0D=SPS + PFO3 0E=PFO3 + Cluster 0F=SPS + PFO3 + Cluster  SPS Sensor Power Supply PFO Power Failure Option	
<ul style="list-style-type: none"> <li>'Ho' homing is running</li> </ul>	H	o		



### 4.9.2 Operation

Description / Mode	Digit 1	Digit 2	Digit 3	Digit 4
INIT (start up)	I	n.		
INIT (start up, leak tight)	I	n.		C
CLOSE	C.	<b>C, 0...100</b> valve position  C = closed, leak tight 0 = minimal conductance 100 = maximum opened		
OPEN	O.			
PRESSURE control	P.			
POSITION control	A.			
INTERLOCK Valve closed or open by digital input	I.			
HOLD (position frozen)	H.			
LEARN	L.			
SAFETY Refer to «Safety mode» for details.	S.			
POWER FAILURE	F.			

### 4.9.3 Error

Description	Digit 1	Digit 2	Digit 3	Digit 4
Error number (xyz)	E.	x	y	z
alternately (if error code exist)				
Error code		u	v	w



For Error number / code. Refer to «Trouble shooting» for details

## 4.10 System Settings and States

### 4.10.1 Identification

#### 4.10.1.1 Serial Number

*Location: CPA/Parameters: System.Identification.Serial Number*

Parameter	Description
<b>Serial Number</b>	VAT specific number

#### 4.10.1.2 Configuration

*Location: CPA/Parameters: System.Identification.Configuration*

Parameter	Description
<b>Valve Series</b>	3-digit value representing the VAT valve series
<b>Valve Variant</b>	For some valve there exists different variants
<b>Nominal Diameter</b>	DN in mm. E.g DN250
<b>Drive Parameter ID</b>	ID of the last drive file loaded on the valve. Sets the parameters responsible for the movement characteristics of the valve
<b>Configuration Parameters ID</b>	ID of the last configuration file loaded on the valve. Configuration of Interface, Pressure Control, Pressure Sensor, ...

#### 4.10.1.3 Firmware

*Location: CPA/Parameters: System.Identification.Firmware*

Parameter	Description
<b>Valve Firmware ID</b>	VAT specific identification number
<b>Valve Firmware Version</b>	Faa.bb.cc.dd a = Platform, Controller Type b = Type <b>C</b> ustomer <b>B</b> asis <b>P</b> roduction <b>T</b> est c = Version d = Revision
<b>CPA Version</b>	VAT PC software version
<b>Interface Firmware Version</b>	Network controller firmware
<b>Motion Controller Firmware Version</b>	Motion controller firmware

#### 4.10.1.4 Hardware

*Location: CPA/Parameters: System.Identification.Hardware*

Parameter	Description
<b>Controller Type</b>	Identification of the use controller IC2H1, IC2H2, IC2H3 ...
<b>Interface Type</b>	RS232/RS485 EtherCAT DeviceNet Logic Profibus CCLink EtherNet
<b>Option Type</b>	none SPS PFO Cluster SPS & PFO SPS & Cluster PFO & Cluster SPS & PFO & Cluster SPS...Sensor Power Supply PFO...Power Failure Option

#### 4.10.2 Statistics

*Location: CPA/Parameters: System.Statistics*

Parameter	Description
<b>Start Up Counter</b>	Each start up is counted (power on and resets) Can be used to monitor whether the valve has restarted uninvited (power loss, watchdog, ...)
<b>Total Time Powered Up</b>	In seconds
<b>Time Since Power On</b>	In seconds

### 4.10.3 Warning/Error

*Location: CPA/Parameters: System.Warning/Error*

Parameter	Description			
<b>Warning Bitmap</b>	Bit	Hex	Description	
	0	1	No Learn Data	
	1	2	Isolation valve does not work	
	2	4	No Sensor Active	
	3	8	PFO Not Ready	
	4	16	Cluster Slave Offline	
	6	40	Fieldbus Data Not Valid	
	8	256	Compressed Air Not Falling when valve close	
	9	512	Compressed Air Too Low	
	10	1024	Compressed Air Too High	
	12	4096	Fan stall alarm	
	<b>Error Bitmap</b>	Bit	Hex	Description
		0	1	Homing Position Error
1		2	Homing Not Running	
2		4	Homing Error State	
3		8	Operation Position Error	
4		10	Operation Not Running	
5		20	Operation Error State	
12		1000	Other Component	
30		40000000	General	
31		80000000	Internal	
<b>Error Number</b>	Refer to Error Number in Troubleshooting			
<b>Error Code</b>	Refer to Error Code in Troubleshooting			

### 4.10.4 Service

#### 4.10.4.1 Restart, Error Recovery

*Location: CPA/Parameters: System.Services*

Parameter	Description
<b>Restart Controller</b>	Emulates a power cycle of the valve
<b>Error Recovery</b>	Attempts to reset the Control Mode Error without restarting the valves

#### 4.10.4.2 Settings Handling

*Location: CPA/Parameters: System.Services.Store/Restore Settings*

Parameter	Description
<b>Store User Parameters</b>	Emulates a power cycle of the valve
<b>Restore User Parameters</b>	Attempts to reset the Control Mode Error without restarting the valves
<b>Restore Factory Parameters</b>	Protective function against changing the settings. If TRUE, the settings can no longer be changed.

*Location: CPA/Parameters: System.Services.Configuration Lock*

Parameter	Description
<b>Configuration Lock Mode</b>	Protective function against changing the settings. If TRUE, the settings can no longer be changed.

## 4.11 Valve Settings and States

### 4.11.1 States

*Location: CPA/Navigation/Parameters: Valve*

Parameter	Description
<b>Actual Position</b>	Show position of the valve plate
<b>Position State</b>	Intermediate Closed Open
<b>Isolation State</b>	Not Isolated Isolated

### 4.11.2 Homing

After power up or possibly after a reset of the valve homing is necessary to determine the plate position.

*Location: CPA/Navigation/Parameters: Valve.Homing*

Parameter	Description
<b>Start Condition</b>	Homing start option defines when the valve performs the homing procedure. <i>Standard</i> Automatically if valve is not in sealed state, otherwise it is waiting for a move command. <i>Open Command</i> On an open command <i>Move Command</i> On any move command <i>At Startup</i> All the time <i>Homing Command</i> On homing command <i>Move Command Without Close</i> On any move command except close command if the valve is closed
<b>End Control Mode</b>	This control mode is set after a successful homing. <i>Position</i> <i>Close</i> <i>Open</i> <i>Pressure Control</i>
<b>End Position</b>	In case the <b>End Control Mode</b> is set to 2 (Position), this parameter defines which position is set after successful homing.

Followed description of the **standard setting**:

Valve position before power up:	Reaction of valve:
Closed (isolated)	Valve remains closed. Homing will be done when first movement command is received.
All other than closed (not isolated)	Valve do homing to initialize position. Display shows 'Ho' until homing is done Valve position after homing is closed

### 4.11.3 Cycle Counter

#### 4.11.3.1 Control Cycle

A control cycle is a complete movement of the valve, from closing to opening and back to closing, or in percentage of movement it is 200%. Each movement is added up until 200% of the movement is reached, and then the cycle counter is incremented by 1.

*Location: CPA/Parameters: Valve.Position Cycle Counter*

Parameter	Description
<b>Control Cycles</b>	The value is writable to be able to reset it
<b>Control Cycles Total</b>	Non-resettable value

#### 4.11.3.2 Isolation Cycle

Counts each compression of the O-ring during the closing process (Each transition of **Isolation State** from 'Not Isolated' to 'Isolated')

*Location: CPA/Parameters: Valve.Position Cycle Counter*

Parameter	Description
<b>Isolation Cycles</b>	The value is writable to be able to reset it
<b>Isolation Cycles Total</b>	Non-resettable value

### 4.11.4 Position Restriction

This allows the position of the valve to be limited in open direction.

The limitation is effective in any control mode

If restriction is active:

- **Position State** remains in Intermediate
- Digital outputs Open becomes not active

*Location: CPA/Parameters: Valve.Position Restriction*

Parameter	Description
<b>Enable</b>	Enable the restriction
<b>Maximum Position</b>	High position limit
<b>Restriction Active</b>	Indicates that the position is currently restricted by the Position Restriction.

## 4.11.5 Position Adaption

### 4.11.5.1 Usage

#### Chamber Matching

Adjustment of the conductance curve of different valves to obtain the same position at the same process points in different systems.

#### Cluster Balance

Adjusting the Position of individual valves in a valve cluster can be used to compensate certain Side-effects, e.g. keeping suction rate of downstream pump on a defined level.

### 4.11.5.2 Parameters

Location: CPA/Parameters: Valve.Position Adaption

Parameter	Description
<b>Enable</b>	Enables the adaption
<b>Mode</b>	Mode of the adaption. Currently only <i>Offset</i> is available.
<b>Actual Position Mode</b>	Selection of the position which the valve indicates <i>Real</i> <i>Adapted</i>
<b>Offset</b>	Amount of displacement of the position
<b>Target Position In</b>	Value sent via Interface or CPA Is the same as <b>Position Control.Target Position</b>
<b>Target Position Used</b>	Internal used Target Position = Target Position In + Offset
<b>Actual Position Real</b>	Internal real position If setting <b>Actual Position</b> = <i>Real</i> the valve indicates this position
<b>Actual Position Adapted</b>	Actual Position Real – Offset If setting <b>Actual Position</b> = <i>Adapted</i> the valve indicates this position

Example: shows parameter window with the offset values and behind the main window with the position values

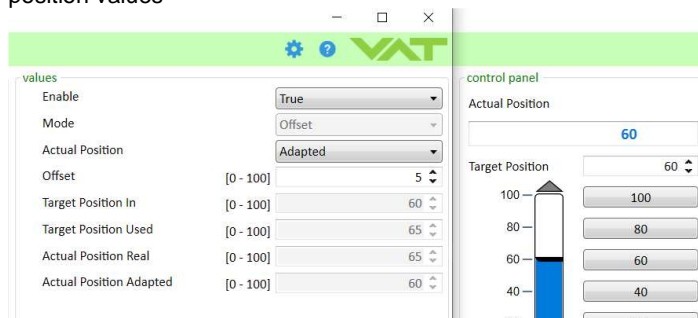

### 4.12 Interface CC-Link

- Control Communication Link (CC-Link) is an open network
- Developed 1996 by Mitsubishi Electric, published in 1999
- Based on RS485 standard
- Administered as a fully open architecture by the CC-Link Association (CLPA, [www.cc-link.org](http://www.cc-link.org))
- Up to 64 stations
- With the maximum speed of 10 Mbps, it provides a transmission range of 100 meters.
- Master/Slave network with Floating Masters and hot swap of stations

- Only remote I/O connected
- Only remote Device connected (Each occupy one station)
- Only Local/Intelligent Device connected (Each occupy one station)

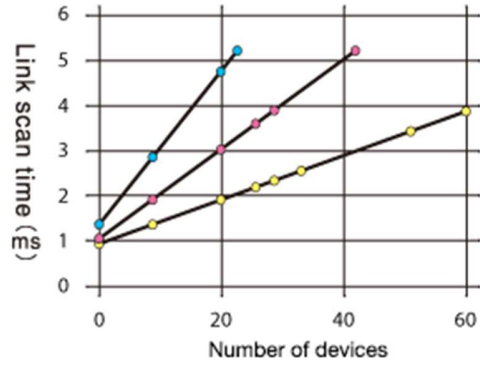



#### 4.12.1 Connection

##### 4.12.1.1 Pinning

The CC-Link interface connector is DB9F (DB-9 pin female), it is galvanically isolated from the rest of the controller.

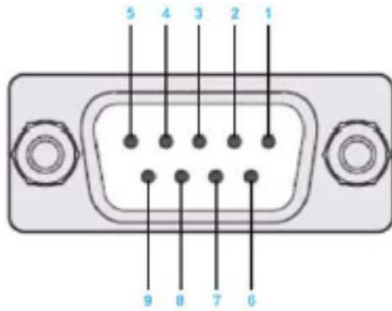

PIN	Signal	Description
1	-	
2	-	
3	DA	Positive RS485 RxD/TxD
4	DG	Signal Ground
5	-	
6	-	
7	-	
8	DB	Negative RS485 RxD/TxD
9	-	
Housing	Cable Shield	Internally connected to the protective earth via cable shield filters.

4.12.1.2 CC-Link cable installation (example)

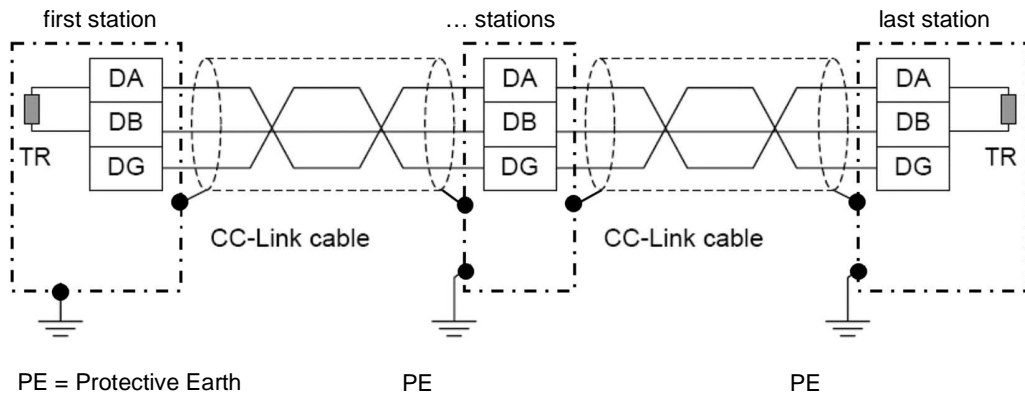

- - - = Connector housing

TR = Terminal resistor (Must be compatible to used CC-Link cable version!)



The valve can be defined as «first station», «...stations...» between first and last, or «last station».

**If the valve at first or last station, «TR» must be installed between DA and DB.**

The station type for VAT valves are: Version 2 Remote Device Station.

4.12.1.3 CC-Link network and cable



For detail information about «**CC-Link cable, wiring and TR**» refer to CC-Link homepage: <http://www.cc-link.org> > «CC-Link Cable Wiring Manual»

## 4.12.2 LEDs

The communication status LEDs are used to represent the CC-Link Slave status.

### 4.12.2.1 LED L-Run

State	Meaning
Off	Power Off Connection with network not yet established No carrier can be recognized Timeout occurred Hardware reset happened
Green	Participating, normal operation After establishing the connection with the CC-Link network, the device is receiving the cyclic data
Red	Major fault (FATAL error)

### 4.12.2.2 LED L Err

State	Meaning
Off	Power Off Normal communication Hardware is resetting
Red	CRC error Address parameter error (Address 0, or greater than 64 is set, including number of occupied stations) Error in settings of baud rate switches while pulling the reset (5 or greater)
Red Blinking	Switch position has been changed while pulling the reset (It blinks for 0.4 seconds)

### 4.12.3 Parameters

Location: CPA/Parameters.Interface CCLink

Parameter	Description
<b>Station Number</b>	When assigning stations to the CC-Link network, unique station numbers must be used in consecutive order and without duplication. 1...64
<b>Transmission Speed</b>	The same Transmission Speed for all stations in the bus and also for the master station must be used. If one of the settings is different for at least one station, the data connection cannot be established.. 156 kbps 625 kbps 2.5 kbps 5 Mbps 10 Mbps
<b>Number of Occupied Stations</b>	The number of stations (occupying one stations worth of memory area) used by a single slave station in a network. 1 4
<b>Extended Cycling Setting</b>	In the extended cyclic transmission, the extended cyclic points can be set as 2 times or 8 times of the normal cyclic transmission points. Double Octuple
<b>Vendor Code</b>	2407
<b>Model Type</b>	77
<b>Software Version</b>	1
<b>Profile</b>	Standard [1.0]

The VAT slave supports two combinations of the CC-Link parameter settings.

Number of Occupied Stations	Extended Cycling Setting
1	Octuple
4	Double

#### 4.12.4 Cyclic Data Setting

For each of followed pressure and position value in the cyclic data the data type and the range can be set:

<b>Input</b>	<b>Actual Pressure</b>
	<b>Sensor 1 Pressure</b>
	<b>Sensor 2 Pressure</b>
	<b>Actual Position</b>
	<b>Actual Target Position</b>
<b>Output</b>	<b>Target Pressure</b>
	<b>Target Position</b>
	<b>Zero Adjust Target Pressure</b>
	<b>Pressure Input Digital Sensor 1</b>
	<b>Pressure Input Digital Sensor 1</b>

Location: CPA/Parameters.Interface CCLink.Cyclic Data Settings

Parameter	Description
<b>Data Type</b>	Signed Integer Floating Point
<b>Value Min</b>	Standard: 0
<b>Value Max</b>	Standard: 100000 for position values 1000000 for pressure values

Floating point is in IEEE-754 standard

View in the CPA:

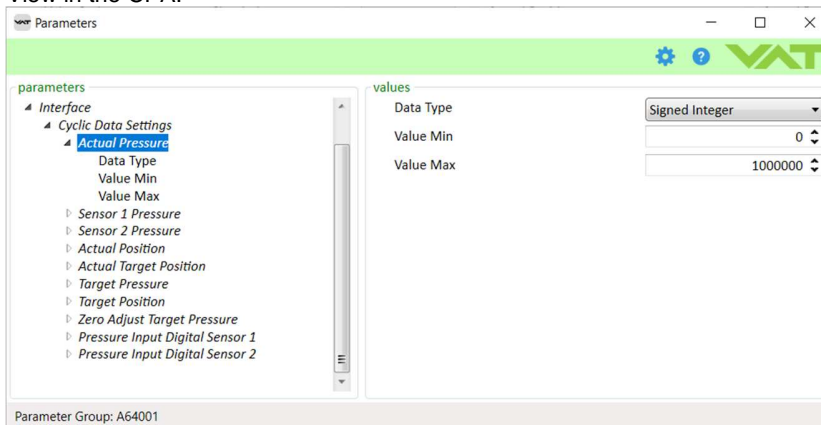

### 4.12.5 Handshaking

Before the CC-Link slave station (VAT valve) can be operated by the CC-Link Master (PLC), handshaking is necessary. If the handshake is not done, no data from the master will be transmitted to station.

An indication of a successful handshaking is the bit «FIELDBUS DATA VALID» (= 1) in the input buffer > GENERAL STATUS.

The CC-Link “Network failure” is independent of the CC-Link handshaking. That means the “Network failure” is inactive if the handshaking is not done yet.

Procedure:

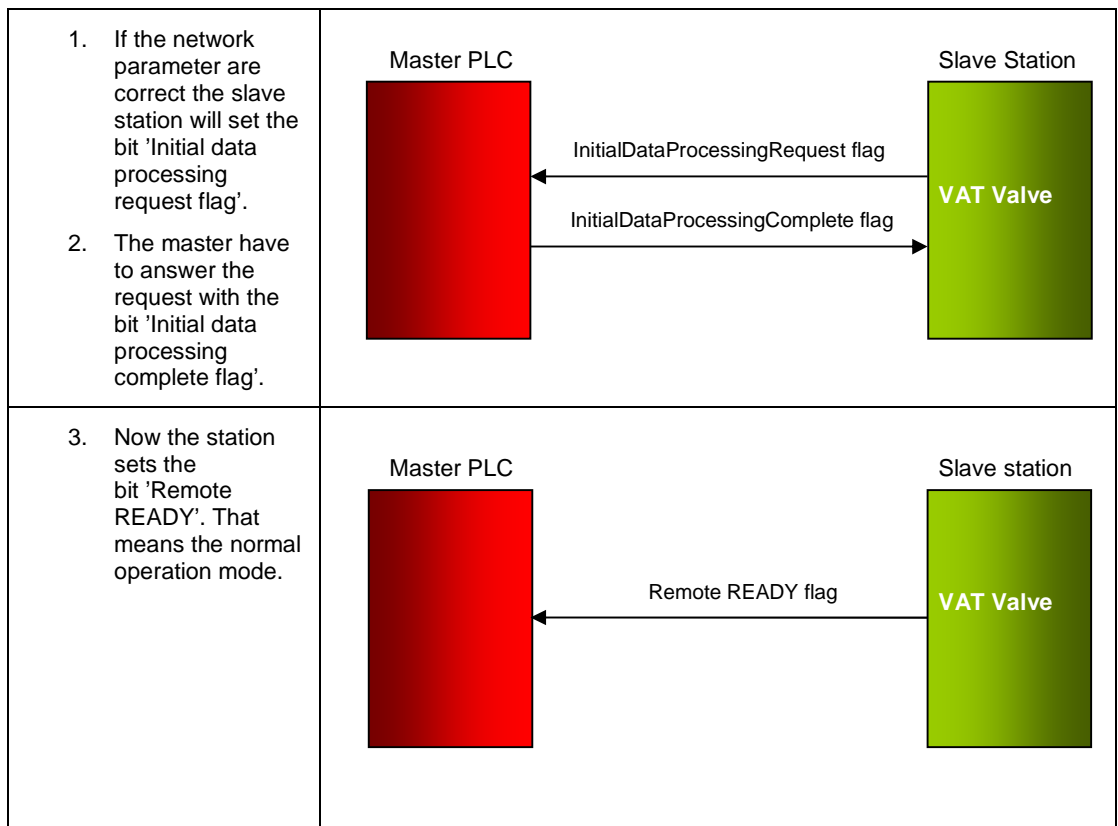

The Flag 'Remote READY' from slave station must be set for normal operation.

#### 4.12.6 Location of the handshaking bits

Slave → Master		Master → Slave	
Device	Signal name	Device No.	Signal name
RX m0	Not used	RY m0	Not used
RX m1		RY m1	
RX m2		RY m2	
RX m3		RY m3	
RX m4		RY m4	
RX m5		RY m5	
RX m6		RY m6	
RX m7		RY m7	
RX m8		RY m8	
RX m9		RY m9	
RX mA		RY mA	
RX mB		RY mB	
RX mC		RY mC	
RX mD		RY mD	
RX mE		RY mE	
RX mF		RY mF	
to	to		
RX(m+n)0	Reserved	RY(m+n)0	Reserved
RX(m+n)1		RY(m+n)1	
RX(m+n)2		RY(m+n)2	
RX(m+n)3		RY(m+n)3	
RX(m+n)4		RY(m+n)4	
RX(m+n)5		RY(m+n)5	
RX(m+n)6		RY(m+n)6	
RX(m+n)7		RY(m+n)7	
RX(m+n)8	Initial data processing request flag	RY(m+n)8	Initial data processing complete flag
RX(m+n)9	Initial data setting complete flag	RY(m+n)9	Initial data setting request flag
RX(m+n)A	Error status flag	RY(m+n)A	Error reset request flag
RX(m+n)B	Remote READY	RY(m+n)B	Reserved
RX(m+n)C	Reserved	RY(m+n)C	
RX(m+n)D		RY(m+n)D	
RX(m+n)E		RY(m+n)E	
RX(m+n)F		RY(m+n)F	

Table 1: Bit Memory Map Profile of VAT CC-Link slave

m: Address assigned to the master module by the station number setting. This means that the address range for this slave begins at address m of the master.

n: Dependent on the VAT Operational settings mode (number of occupied stations and number of extension cycles)

- Operational settings mode = 1 → n = 0x7 (hex)
- Operational settings mode = 4 → n = 0xD (hex)

Example see chapter: 4.7.3 Example of the handshaking by a **PLC-program**.

#### 4.12.7 Example of the handshaking by a PLC-program

The following program sends an answer to the VAT CC-Link station which return a "Remote READY" flag. It is important to correct register address is used. In this example the address for this slave station (valve) starts at 1000 (hex). So  $m = 100$  (see capture: Location of the handshaking bits). The Operational setting mode of the slave is 4 – therefore  $n = D$ .

Table 1 said  $RX(m+n)8$  for the location of the 'Initial data processing request flag'. So the address X10D8 is used. For the 'Remote Ready' flag the address  $RX(m+n)B = X10DB$  is used.

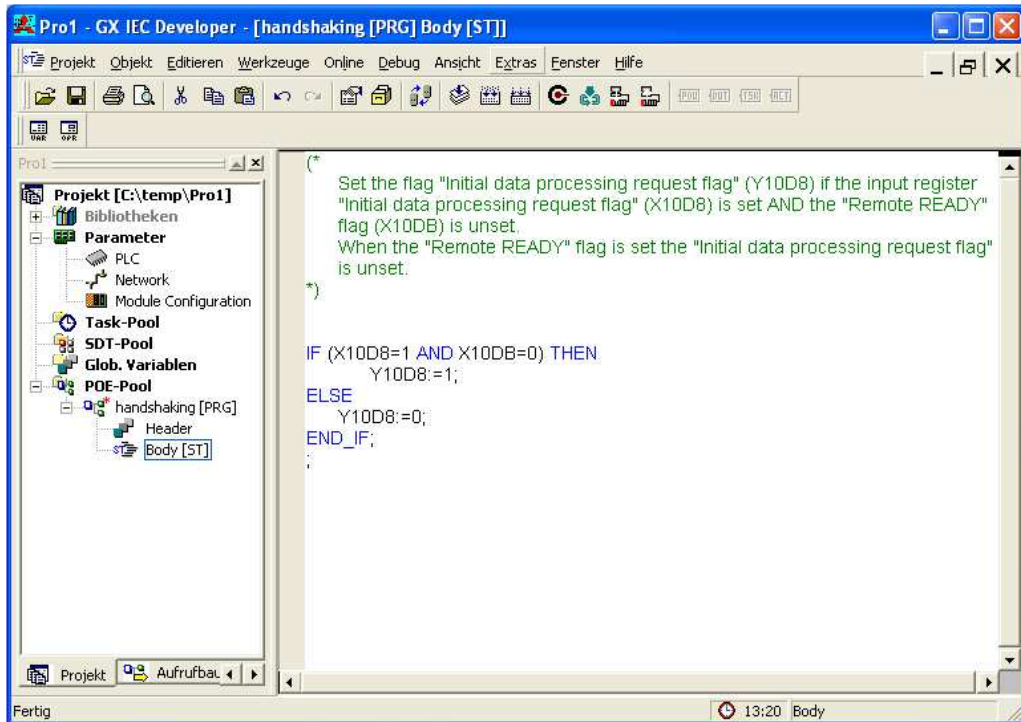



#### 4.12.8 Process data – cyclic communication

- The buffer naming is in view from customer (master) PLC.
- Data format: All signals are transmitted and received in intel format (low byte first).
- All one-byte signals use the least significant byte (LSB).



Neither valve display information nor CONTROL MODE values or any other fieldbus cyclic/acyclic data are related to any fieldbus states/notation

#### 4.12.9 OUTPUT Buffer (Master PLC)

##### 4.12.9.1 Overview

Data model	Index	Buffer	
		Contents (MSB)	Contents (LSB)
16 bit (Word)	0	Target Pressure	
	1		
	2	Target Position	
	3		
	4	Zero Adjust Target Pressure	
	5		
	6	Pressure Input Digital Sensor 1	
	7		
	8	Pressure Input Digital Sensor 2	
	9		
	10	<i>Not used – reserved</i>	Control Mode Target
	11	General Control Setpoint	
	12	PKW PKE	
	13	PKW IND	
	14	PKW PWE	
	15	PKW PWE	
	16	Cluster Slave Freeze Position	
	17		
	18	<i>Not used – reserved</i>	Cluster Slave Freeze Address
	19	Cluster Valve Control Setpoint	
20	<i>Not used – reserved</i>	Monitoring Address	



For data consistency make sure your master PLC is supporting “block guarantee of cyclic data per station”.

## 4.12.9.2 OUTPUT

Index	Name	Size Byte	Data Type	Description	Default Range
0	Target Pressure	4	SINT32 or FLOAT	Used as the target value In case the valve is in pressure mode (5),	0 - 1'000'000
2	Target Position	4	SINT32 or FLOAT	Used as the target value in case the valve is in position mode (2)	0 - 100'000
4	Zero Adjust Target Pressure	4	SINT32 or FLOAT	Typically 0, when the chamber is completely pumped down. Valid values between -1.4V and 1.4V	0 - 1'000'000
6	Pressure Input Digital Sensor 1	4	SINT32 or FLOAT	Input from digital sensor 1	0 - 1'000'000
8	Pressure Input Digital Sensor 2	4	SINT32 or FLOAT	Input from digital sensor 2	0 - 1'000'000
10	Control Mode Target	2	UINT8	2 = Position 3 = Close 4 = Open 5 = Pressure 6 = Hold: Valve to be kept in current position (Valid for Position and Pressure mode) 7 = Learn: Valve starts the internal learn procedure	
11	General Control	2	UINT16	Bitmap, see details below.	
12	PKW PKE	2	UINT16	Refer to PKW below	
13	PKW IND	2	UINT16		
14	PKW PWE1	2	UINT16		
15	PKW PWE2	2	UINT16		
16	Slave Freeze Target Position <sup>1)</sup>	4	SINT32 or FLOAT	Position used as target when the addressed slave is frozen.	0 - 100'000
18	Slave Control Address <sup>1)</sup>	2	UINT8	Slave, which will be addressed for individual control	
19	Slave Control <sup>1)</sup>	2	UINT16	Action that is applied to the addressed slave valve. For details refer to Slave Control bitmap below in this manual	
20	Slave Monitoring Address <sup>1)</sup>	2	UINT8	Address of the slave that should report back following parameters within the input buffer: - Slave Actual Position - Slave Control Mode - Slave Status - Slave Warnings	

<sup>1)</sup> Only with cluster option

**General Control – Bitmap**

Bit	Name	Description									
0	Zero	Change of the bit from 0 to 1 imitates the ZERO adjust. The actual pressure signal is set to <b>Zero Adjust Target Pressure</b> (normally 0) The valid range for adjustment is limited to range from -1.4V to+1.4V. Otherwise, the sensor must be adjusted!									
1	Not used	Reserved									
2	Ping Pong Tx BIT	Handshaking mechanism See chapter Ping Pong Bit below.									
3	Not used	Reserved									
4	Access Mode Locked	Change of the bit changes the Access Mode  <table border="1"> <thead> <tr> <th>Access Mode Before</th> <th>Action</th> <th>Access Mode After</th> </tr> </thead> <tbody> <tr> <td>Local or Remote</td> <td>0 → 1</td> <td>Locked</td> </tr> <tr> <td>Locked</td> <td>1 → 0</td> <td>Remote</td> </tr> </tbody> </table> Example: From local to remote: 0 → 1, 1 → 0	Access Mode Before	Action	Access Mode After	Local or Remote	0 → 1	Locked	Locked	1 → 0	Remote
Access Mode Before	Action	Access Mode After									
Local or Remote	0 → 1	Locked									
Locked	1 → 0	Remote									
5 – 15	Not used	Reserved									

**Slave Control – Bitmap**

Bit	Name	Description
0	Freeze	Activate Freeze at addressed Slave
	Freeze Mode	Define Control Mode, for 'Frozen' Slave 0: Position 1: Close
2	Data Valid	Indicates if received data is within the defined ranges
3 - 15	Not Used	Reserved

## 4.12.10 INPUT Buffer (Master PLC)

### 4.12.10.1 Overview

Data model	Index	Buffer	
		Contents (MSB)	Contents (LSB)
16-Bit (Word)	0	Actual Pressure	
	1		
	2	Pressure Sensor 1	
	3		
	4	Pressure Sensor 2	
	5		
	6	Actual Position	
	7		
	8	Actual Target Position	
	9		
	10	<i>Not used – reserved</i>	Control mode
	11	Error Number	
	12	PKW PKE	
	13	PKW IND	
	14	PKW PWE1	
	15	PKW PWE2	
	16	General status	
	17	General warnings	
	18	Extended warnings	
	19	<i>Not used – reserved</i>	Cluster Monitoring Address
	20	Cluster Valve Position	
	21		
	22	<i>Not used – reserved</i>	Cluster Valve Control Mode
	23	Cluster Valve Status	
24	Cluster Valve Warnings		



## 4.12.10.2 Detail

Index	Name	Size Bytes	Data Type	Description	Default Range
0	Actual Pressure	4	SINT32 or FLOAT	Represents the current prevailing Pressure in the set Range.	0 - 1'000'000
2	Pressure Sensor 1	4	SINT32 or FLOAT	In case of default valid range: Physical full-scale value of the sensor (10 Volt) equals to 1'000'000.	0 - 1'000'000
4	Pressure Sensor 2	4	SINT32 or FLOAT	Optional signal, only in case of 2-sensor version. In case of default valid range: Physical full-scale value of the sensor (10 Volt) corresponds to 1'000'000.	0 - 1'000'000
6	Actual Position	4	SINT32 or FLOAT	Maximal value in the range = Valve is open Minimal value in the range = Valve is closed*. *Valid for valves without isolation function	0 - 100'000
8	Actual Target Position	4	SINT32 or FLOAT	Last received Target Position, in the set range.	0 - 100'000
10	Control Mode	2	UINT8	0 = Init                    7 = Learn 1 = Homing                8 = Interlock Open, 2 = Position              9 = Interlock Close 3 = Close                 10 = Maintenance 4 = Open                  12 = Power Failure 5 = Pressure Control    13 = Safety 6 = Hold                  14 = Error	
11	Error Number	2	UINT16	IC Compatible Error Numbers: 20 = no stop detected during homing 21 = valve blocked during homing 22 = valve blocked 40 = motor driver fault	
12	PKW PKE	2	UINT16	Refer to PKW below	
13	PKW IND	2	UINT16		
14	PKW PWE1	2	UINT16		
15	PKW PWE2	2	UINT16		
16	General Status	2	UINT16	See Fehler! Verweisquelle konnte nicht gefunden werden.	
17	General Warnings	2	UINT16		
18	Extended Warnings	2	UINT16		
19	Slave Address <sup>1)</sup>	2	UINT8	Address of the slave that reports back following parameters: Slave Actual Position, Slave Control Mode, Slave Status, Slave Warnings	
20	Slave Actual Position <sup>1)</sup>	4	SINT32 or FLOAT	Value of the selected slave by "Slave Monitoring Address" in Output Buffer	0 - 100'000
32	Slave Control Mode <sup>1)</sup>	2	UINT8	Value of the selected slave by "Slave Monitoring Address" in Output Buffer	
33	Slave Status <sup>1)</sup>	2	UINT16	Value of the selected slave by "Slave Monitoring Address" in Output Buffer	
34	Slave Warnings <sup>1)</sup>	2	UINT16	See detail below	

<sup>1)</sup> Only with cluster option

**General Status – Bitmap**

Bit	Name	Description												
0	Fieldbus Data Valid	Communication over the bus is running errorless												
1	Zero Executed	ZERO successful executed, active for 2 seconds												
2	Ping Pong RX	Inverted bit "Ping Pong TX" from 'General Control setpoint' bitmap. Details given in chapter Ping Pong Bit.												
3	Pressure Simulation	Internal pressure simulation is active. Real sensor inputs are being ignored												
4	Target Pressure Reached	Actual pressure is within 2% of the target pressure												
5	Iso Valve Open	External valve isolation is in state Open												
6	Iso Valve Close	External valve isolation is in state Close												
7,8	Access Mode	<table border="1" style="margin-left: 40px;"> <thead> <tr> <th></th> <th>Bit 7</th> <th>Bit 8</th> </tr> </thead> <tbody> <tr> <td>Local</td> <td>0</td> <td>0</td> </tr> <tr> <td>Remote</td> <td>1</td> <td>0</td> </tr> <tr> <td>Locked</td> <td>0</td> <td>1</td> </tr> </tbody> </table>		Bit 7	Bit 8	Local	0	0	Remote	1	0	Locked	0	1
	Bit 7	Bit 8												
Local	0	0												
Remote	1	0												
Locked	0	1												
9	Warnings Active	At least one bit of General Warnings or Extended Warnings is active.												
10	Sealed	Indicates if the valve is isolated												
11	Interlock Active	Interlock input is active												
12 - 15	Not Used	Reserved												

**General Warnings – Bitmap**

Bit	Name	Description
0	Not Used	
1	Learn Data Set	No valid learn parameter data present. Learn is required for adaptive pressure control.
2	Compressed Air Pressure	Compressed air pressure has not a valid level
3	Power Failure Battery	Battery not ready. Voltage too low
4	Not Used	Reserve
5	Isolation Valve	Position indicator failure of external isolation valve
6	Fan Stall	
7 - 15	Not Used	Reserved

**Extended Warnings – Bitmap**

Bit	Name	Description
0	Remote Control Not Possible	Access Mode <i>Local</i> is active, change to Access Mode <i>Remote</i> or Access Mode <i>Locked</i>
1	Actual Set Control Mode Not Allowed	Not possible to switch the actual Control Mode to Control Mode Target because of reasons: <ul style="list-style-type: none"> <li>• Control mode is interlock or fatal error</li> <li>• Control Mode Target is 5 (pressure), 6 (hold) or 7 (learn) and no sensor is selected (Sensor Configuration)</li> </ul>
2	Zero Disabled	Using zero function not possible
3	PFO Deactivated	Power Failure Option is deactivated
4	Not Used	Reserved
5	Target Pressure	Out of range
6	Target Position	Out of range
7	Not Used	Reserved

8	Pressure Input Digital Sensor 1	Out of range
9	Pressure Input Digital Sensor 2	Out of range
10	Control Mode Target	Out of range
11	General Control Setpoint	Out of range
12 - 15	Not Used	Reserved

#### Slave Warnings – Bitmap

Bit	Name	Description
0	Slave Freeze Target Position	Out of range
1	Slave Control Address	Out of range
2	Slave Control	Out of range
3	Slave Monitoring Address	Out of range
4 - 15	Not Used	Reserved

#### Slave Status – Bitmap

Bit	Name	Description												
0 – 1	Access Mode	<table border="0"> <tr> <td></td> <td>Bit 7</td> <td>Bit 8</td> </tr> <tr> <td>Local</td> <td>0</td> <td>0</td> </tr> <tr> <td>Remote</td> <td>1</td> <td>0</td> </tr> <tr> <td>Locked</td> <td>0</td> <td>1</td> </tr> </table>		Bit 7	Bit 8	Local	0	0	Remote	1	0	Locked	0	1
	Bit 7	Bit 8												
Local	0	0												
Remote	1	0												
Locked	0	1												
2	Freeze Mode	Slave is 'Frozen', no more following the Cluster system												
3	Offline Status	Slave is not communicating with master valve												
4 - 8	Not Used	Reserved												
9	Compressed Air Warning	Compressed air Pressure has not a valid level (Only for valves with compressed air)												
10	PFO Voltage Warning	Voltage of PFO is in low level (Only supported if PFO is available)												
11	Isolation Valve Failure	Invalid state of isolation valve signals: open or close (Only available for Isolation Valves)												
12 - 15	Not Used	Reserved												

**4.12.10.3 PKW mechanism for processing parameters**

PKW is a mechanism used for handling acyclic processing parameters within the Profibus buffer content periodic transfer, which is also used within this Fieldbus methodology. Through that it allows to monitor and change parameter data over the cyclic data communication.

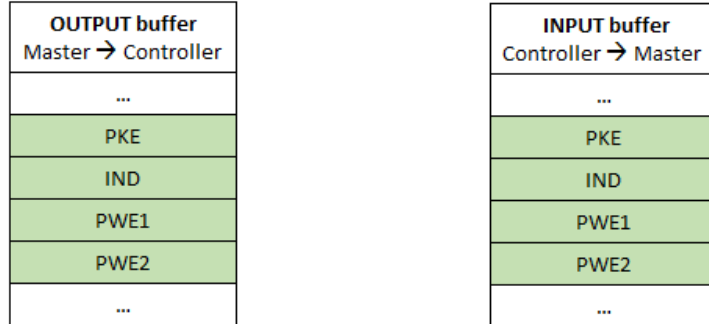

Selection of the parameter and the action

Response of action result and value

Telegram				
Signal			Bit	
<b>PKE</b>	Identifier	PNU	0..10	Parameter Number
		-	11	-
	AK	12..15	Action	
<b>IND</b>	Array Index		8..15	
<b>PWE1</b>	Value High Word		0..15	
<b>PWE2</b>	Value Low Word		0..15	

AK	Request	Response
0	No Request	No response
1	Request parameter value	Transfer parameter value (word)
2	Modify parameter value (word)	Transfer parameter value (double word)
3	Modify parameter value (double word)	-
4	-	Transfer parameter value (array, word)
5	-	Transfer parameter value (array, double word)
6	Request parameter array.value	Transfer number of array element
7	Modify parameter value (array.word)	Not possible to process request (error code in PWE2)
8	Modify parameter value (array.double word)	
9	Request number of array element	

Error Code	Response in PWE2
0	Illegal parameter number
1	No access rights
2	Value out of range
3	Wrong array index
5	Wrong data type
6	Setting not allowed
17	Wrong operating state
20	Wrong value within range
201	Unknown command



**Rules for processing requests/responses**

- A request or a response can only ever refer to one parameter.
- The master must repeat a request continuously until it has received the appropriate response.
- The master detects the response to a request it has sent by
  - evaluating the response identifier
  - evaluating the parameter number PNU
  - evaluating the parameter index IND if necessary, or
  - evaluating the parameter value PWE if necessary.
- The complete request must be sent in one telegram. Request telegrams cannot be split. The same applies to responses.
- In the case of response telegrams which contain parameter values, the drive always returns the momentary parameter value when repeating response telegrams.
- If no information needs to be fetched from the PKW interface in cyclical operation, then the "No request" request telegram must be issued

4.12.10.4 Parameter List

Group	Sub-Group	Name	PNU [hex]	Data Type	Acc	NV	Min	Max	Def	Description
Sensor		<b>Sensor Operation Mode</b>	E6	UINT8	RW	NV	0	4	1	Pressure source for pressure control 0: No Sensor 1: Sensor 1 (S1) 2: S1 High   S2 Low   Soft Switch 3: Sensor 2 (S2) 4: S2 High   S1 Low   Soft Switch 7: S1 High   S2 Low   Target Pressure 8: S2 High   S1 Low   Target Pressure 9: S1 High   S2 Low   Hard Switch 10: S2 High   S1 Low   Hard Switch
		<b>Sensor Full Scale Ratio</b>	E7	FLOAT	RW	NV	1.0	1000.0	10.0	Full scale ratio between high sensor and low sensor ➔ This parameter was used in the past to define the ratio between Sensor 1 & 2, further it was replaced by the <b>Upper limit Data Value</b> . Therefore primarily use the new parameters to define the sensor value range, through that this parameter value will be automatically overwritten.
	Sensor 1	<b>Upper limit Data Value</b>	F4	FLOAT	RW	NV			10.0	Full scale value
		<b>Data Unit</b>	F5	UINT8	RW	NV	0	8	4	Pressure unit of Sensor 1 Upper limit Data Value 0: Pa 1: kPa 2: bar 3: mbar 4: Torr 5: mTorr 6: psi 7: User specific
		<b>Offset Value</b>	FA	FLOAT	RW	NV	-1.4	1.4	0	Used for zero adjust and value represents Voltage offset [in Volt]
		<b>Value</b>	FE	FLOAT	RO	V				ADC measurement value on the sensor input [in Volt]
	Sensor 2	<b>Upper limit Data Value</b>	104	FLOAT	RW	NV			100.0	Full scale value
		<b>Data Unit</b>	105	UINT8	RW	NV	0	8	4	Pressure unit of Sensor 2 Upper limit Data Value 0: Pa 1: kPa 2: bar 3: mbar 4: Torr 5: mTorr 6: psi 7: User specific
		<b>Offset Value</b>	10A	FLOAT	RW	NV	-1.4	1.4	0	Used for zero adjust and value represents Voltage offset [in Volt]
		<b>Value</b>	10E	FLOAT	RO	V				ADC- measurement value on sensor input [in Volt]

Group	Sub-Group	Name	PNU [hex]	Data Type	Acc	NV	Min	Max	Def	Description	
Adaptive	Learn (Standard)	Type	116	UINT8	RW	V	0	2	0	Methodology, how the Learn table data should be calculated 0: Standard 1: Short 2: Calculated	
		Open Speed	117	UINT1 6	RW	NV	1	1000	1000	Open Speed during learn process	
		Maximum Pressure	118	UINT1 6	RW	V	0	1000	1000	Learn procedure will be executed to the Maximum Learn Pressure In % of sensor upper limit (high sensor)	
	Short Learn	State	119	UINT1 6	RO	V	0	65535	0	Bit 0: Learn is running Bit 1: Checksum error (learn data corrupt) Bit 2: Learn procedure terminated by user Bit 3: Pressure at position open > 50% of pressure limit Bit 4: Pressure at minimal conductance position < 10 % of pressure limit Bit 5: Pressure fall's while move valve in direction of close Bit 6: Pressure at open position does not match pressure of previous open Bit 10: Learn procedure terminated by program Bit 11: Pressure <= 0 at open position (no gas flow set?)	
		Chamber Volume	122	FLOAT	RW	NV	0.1	1E^6	50.0	Essential for Short and Calculated Learn type	
		Pumping Speed	123	FLOAT	RW	V	0.1	1E^5	1.0	Output of short learn	
		Gas Flow Value	124	FLOAT	RW	V			100.0	Used constant Gas flow value Needed in case of Short Learn	
	Pressure Control	Controller 1 (Adaptive)*	Gas Flow Unit	125	UINT8	RW	V	0	7	5	Unit of Adaptive Learn Gas Flow values 0: pa m3 s-1 1: mbar l s-1 2: Torr l s-1 3: Atm cm3 s-1 4: luesec 5: sccm 6: slm 7: mol s-1
			Controller Selector	199	UINT8	RW	NV	0	3	0	Used Controller 0: Controller 1 (Adaptiv) 1: Controller 2 (PI) 2: Controller 3 (PI) 3: Controller 4 (Softpump)
			Sensor Delay	19A	FLOAT	RW	NV	0	1	0	Only relevant if adaptive control algorithm
			Ramp Time	19B	FLOAT	RW	NV	0	1E^6	1	Time in sec to reach target pressure
			Ramp Time Mode	19C	UINT8	RW	NV	0	1	0	0: Ramp Time (maximal time reaching target pressure) 1: Time from 0 to SFS (constant slope)
	Gain Factor	19E	FLOAT	RW	NV	0.0001	7.5	1.0	Amplification factor, will affect the regulation in either faster or slower reaching the target pressure		

Group	Sub-Group	Name	PNU [hex]	Data Type	Acc	NV	Min	Max	Def	Description
		<b>Ramp Type</b>	19F	UINT8	RW	NV	0	1	0	Used Trajectory form 0: Linear 1: Logarithmic
	<b>Controller 2 (PI)*</b>	<b>Ramp Time</b>	1A5	FLOAT	RW	NV	0	1E^6	0	Time in sec to reach target pressure
		<b>Ramp Time Mode</b>	1A6	UINT8	RW	NV	0	1	0	0: Ramp Time (maximal time reaching target pressure) 1: Time from 0 to SFS (constant slope)
		<b>Control Direction</b>	1A7	UINT8	RW	NV	0	1	0	Defines the type of application 0: downstream 1: upstream
		<b>P-Gain</b>	1A8	FLOAT	RW	NV	0	100.0	0.1	Amplification factor for proportional part
		<b>I-Gain</b>	1A9	FLOAT	RW	NV	0.001	100.0	0.1	Amplification factor for integral part
		<b>Ramp Type</b>	1AA	UINT8	RW	NV	0	1	0	Used Trajectory form 0: Linear 1: Logarithmic
	<b>Controller 3 (PI)*</b>	<b>Ramp Time</b>	1AF	FLOAT	RW	NV	0	1E^6	0	Time in sec to reach target pressure
		<b>Ramp Time Mode</b>	1B0	UINT8	RW	NV	0	1	0	0: Ramp Time (maximal time reaching target pressure) 1: Time from 0 to SFS (constant slope)
		<b>Control Direction</b>	1B1	UINT8	RW	NV	0	1	0	Defines the type of application 0: downstream 1: upstream
		<b>P-Gain</b>	1B2	FLOAT	RW	NV	0	100.0	0.1	Amplification factor for proportional part
		<b>I-Gain</b>	1B3	FLOAT	RW	NV	0.001	100.0	0.1	Amplification factor for integral part
		<b>Ramp Type</b>	1B4	UINT8	RW	NV	0	1	0	Used Trajectory form 0: Linear 1: Logarithmic
	<b>Controller 4 (Softpump)*</b>	<b>Ramp Time</b>	1B9	FLOAT	RW	NV	0	1E^6	0	Time in sec to reach target pressure
		<b>Ramp Time Mode</b>	1BA	UINT8	RW	NV	0	1	0	0: Ramp Time (maximal time reaching target pressure) 1: Time from 0 to SFS (constant slope)
		<b>P-Gain</b>	1BC	FLOAT	RW	NV	0	100.0	0.1	Amplification factor for proportional part
		<b>I-Gain</b>	1BD	FLOAT	RW	NV	0.001	100.0	0.1	Amplification factor for integral part
		<b>Ramp Type</b>	1BE	UINT8	RW	NV	0	1	0	Used Trajectory form 0: Linear 1: Logarithmic
<b>Valve</b>		<b>Valve Speed</b>	190	UINT1 6	RW	NV	1	1000	1000	Valve speed during position and pressure control 1: lowest possible speed 1000: highest possible speed
		<b>Reset Service Request Flag</b>	25D	UINT8	RS	V	0	1	0	Clears the Service Request Flag 0: no action 1: reset flag

\*inherited IC-Compatible PKW Object definitions

## 4.13 Pressure Sensor

### 4.13.1 Mechanical connection requirements

Fast and accurate pressure control requires a fast sensor response. Sensor response time:  $< 50\text{ms}$ . The sensor is usually connected to the chamber by a pipe. The line must be short enough and the conductance must not be reduced by a too small line diameter or a low conductance shut-off valve. To maintain that the response time is not degraded by this connection it needs to meet the following requirements:

- Inner diameter of connection pipe:  $\geq 10\text{ mm}$
- Total length  $L1 + L2$ :  $\leq 300\text{ mm}$

The total conductance value must include all valves and limiting orifices that may also be present. Make also sure that there is no obstruction in front of sensor connection port inside the chamber. The sensor should also be mounted free of mechanical shock and vibration. Dynamic stray magnetic fields may introduce noise to sensor output and should be avoided or shielded.

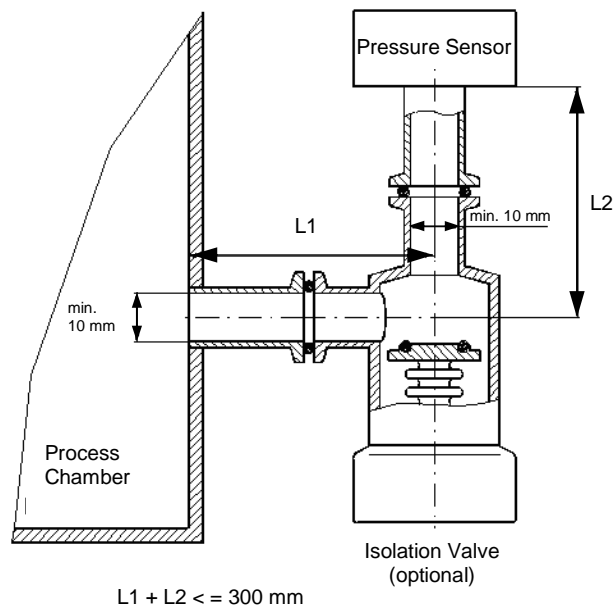

### 4.13.2 Configuration

The CPA window shows a good overview of the sensor settings:

- The valve supports 2 sensors.
- Zero Adjust is for offset compensation of linear sensors
- Crossover is automatic switch over between 2 linear sensors

The screenshot shows the VAT Pressure Sensor configuration interface. It features a top navigation bar with 'Local', 'Remote', and 'Help' tabs. The main area is split into two columns for 'sensor 1' and 'sensor 2'. Each sensor configuration includes checkboxes for 'Available' and 'Enable', dropdown menus for 'Input Source' and 'Scale', and a 'range' section with 'Data Unit' and 'Upper/Lower Limit Data Value' fields. Below these are 'zero adjust' and 'filter' sections with 'Enable' checkboxes and 'Offset Value' or 'Time [s]' input fields. At the bottom, a 'zero adjust' section allows for 'Sensor Selection' and 'Target Pressure' setting, with an 'Execute Zero Adjust' button. A 'crossover' section includes 'Crossover Mode' and 'Threshold High/Low' settings. A note on the right side provides instructions for the zero adjust process: 'Prior to executing a zero adjust: - Open Valve - Ensure no gas-flow in system'.

*Location: CPA/Navigation/Parameters: Pressure Sensor.Sensor 1, Pressure Sensor.Sensor 2*

Parameter	Description
<b>Available</b>	Set to 'True' if a sensor is connected
<b>Enable</b>	Set to 'True' if the sensor signal is used for pressure control
<b>Input Source</b>	<p>'Analog'      Sensor has an analog voltage interface and is direct connected to the valve.</p> <p>'Digital'      Sensor has an EtherCAT interface and is connected to the EtherCAT bus</p> <p>'Simulation'      Testing the valve and pressure control without being connected to the system</p>
<b>Range.Scale</b>	<p>Select type of the sensor signal</p> <p>'Linear'</p> <p>'Logarithmic'</p> <p>Most gauges are linear type gauges.</p>
<b>Range.Data Unit</b>	<p>Set the pressure data unit of the gauge:</p> <p><b>Pa, kPa, bar, mbar, Torr, mTorr, psia, psig</b></p>
<b>Range.Upper Limit Data Value</b> <b>Range.Lower Limit Data Value</b>	<p>Set the upper limit and lower limit of the gauge in the unit of "Range.Data Unit"</p> <p>Example for a 250mTorr linear sensor:</p> <p>Upper Limit = 250.0</p> <p>Lower Limit = 0.0</p>
<b>Range.Upper Limit Voltage Value</b> <b>Range.Lower Limit Voltage Value</b>	<p>These parameters are only used for gauges with analog voltage interface.</p> <p>The values corresponds to Range.Upper Limit Data Value and Range Lower Limit Data Value</p> <p>Example:</p> <p>Upper Limit: 10.0V → 250mTorr Range Upper Limit Data Value</p> <p>Lower Limit: 0.0V → 0.0mTorr Range Lower Limit Data Value</p>
<b>Filter.Enable</b>	'True' enables the filter
<b>Filter.Type</b>	<p>Set the filter type, which should be applied to the related Sensor Input:</p> <p><b>Low-pass, Low-pass Simple, Median, Moving Average, Line Frequency Suppression, FIR custom</b></p>
<b>Filter.Time</b>	<p>Set filter time in the range of 0.0 to 1.0 second.</p> <p>Note: Filter delays the sensor signals which is detrimental for pressure control</p>
<b>Value</b>	The actual Pressure value of the regarding Sensor

### 4.13.3 Crossover (2 sensor operation mode)

If two sensors are connected to the controller uses both for pressure control and pressure feedback. The controller selects each sensor or blends both sensor signals to the “**Actual Pressure**” used for control and feedback. Three different modes are selectable.

*Location: CPA/Navigation/Parameters: Pressure Sensor.Crossover*

Parameter	Description
<b>Crossover Mode</b>	Crossover between 2 sensors (see below)
<b>Threshold High [SFS low sensor]</b>	Defines the crossover area (see below)
<b>Threshold Low [SFS low sensor]</b>	The value is related to sensor full scale of low sensor (0.1 means 10% of sensor full scale of low sensor)
<b>Delay</b>	Switch over delay in Crossover Mode 'Hard Switch'

**Crossover Mode Soft Switch**

Between the *Threshold Low* and *Threshold High* the controller blends both pressure signals to the actual pressure.

**When to use**  
This is the standard mode. Both pressure signals need to match in the crossover range otherwise crossover effect result (nonlinearity). Sensor full scale ratio low range to high range sensor must not exceed 1:100

---

**Crossover Mode Hard Switch**

Switching between sensors according to the hysteresis threshold levels and an optional delay.

**When to use**  
Preferred setting if the sensor signals do not fit together in the crossover area (for example if sensor ratio is high).

---

**Crossover Mode Target Pressure**

If Target Pressure is below low range sensor full scale low sensor is used; otherwise high range sensor.

**When to use**  
As there is no switchover during pressure control while using this setting, undesired effects like nonlinearity or continuous switching between sensors don't occur.

**Note**  
While in position control mode, 'Soft Switch' mode is used



#### 4.13.4 Zero Adjust

Zero Adjust allows for the compensation of the sensor offset voltage.

**Note:** A maximum offset voltage of +/- 1.4 V can be compensated.

*Location: CPA/Navigation/Parameters: Pressure Sensor.Zero Adjust*

Parameter	Description
<b>Zero Adjust.Sensor Selection</b>	Select the sensor for the zero adjust: <ul style="list-style-type: none"> <li>• Sensor 1 + 2</li> <li>• Sensor 1</li> <li>• Sensor 2</li> </ul>
<b>Zero Adjust.Target Pressure</b>	Normally this parameter is set to 0 in case the process chamber is fully evacuated (pressure <=1‰ of sensor full scale). If not you can align the sensor value to a known pressure (displayed on another readout in the system). In this case set <b>Target Pressure</b> to the known pressure. <b>Note:</b> Target Pressure is in the unit of pressure, see chapter «Scaling of Pressure and Position Values»
<b>Zero Adjust.Execute</b>	1: Start the zero adjust 2: Clear offset value After executing value return to 0
<b>Sensor 1.Enable</b> <b>Sensor 2.Enable</b>	0: It is not possible to execute a zero adjust. A present offset value is ignored 1: It is possible to execute a zero adjust. A present offset value is respected.
<b>Sensor 1.Offset Value [SFS]</b>	Value which is deducted from the measured sensor value.
<b>Sensor 2.Offset Value [SFS]</b>	The value is related to sensor full scale (0.1 means 10% of sensor full scale)

#### Performing a zero adjust:

1. Turn the gas flow off
2. Fully open the valve
3. Wait until the sensor signal is not shifting anymore. Refer to manual of sensor manufacturer for warm up time.
4. Wait until process chamber is evacuated.



Do not perform Zero Adjust, if the base pressure of your vacuum system is higher than 1‰ of sensor full scale. We recommend disabling Zero Adjust function or using of Zero Adjust.Target Pressure other than 0.0 in this case. Otherwise incorrect pressure reading is the result.

5. Perform zero with setting of Zero Adjust.Execute to 1
6. Check parameter Actual Pressure if the pressure is shifted as expected

### 4.13.5 Logarithmic Pressure

To control wide pressure ranges, it is advantageous to control with a logarithmic signal. Note: Only the PI and the Softpump controller can control with a logarithmic signal. Adaptive controller needs a linear signal.

*Location: CPA/Parameters: Pressure Sensor.General Settings.Logarithmic Pressure*

Parameter	Description
<b>Upper Limit Value</b>	Highest Value of the logarithmic value. Corresponds to the sensor full scale defined in the sensor setup.
<b>Percent Per Decade</b>	Defines the logarithmic scale
<b>Lowest Pressure</b>	Defines the lowest pressure that is converted to a logarithmic value. Corresponds to the smallest valid signal.
<b>Pressure On Interface</b>	Defines which signal scale is used on the interface. Linear Logarithmic
<b>Use Logarithmic Sensor</b>	Set to True to use direct the signal of a logarithmic sensor. <b>Percent Per Decade</b> is then not used. This parameter becomes active only if <b>Pressure Sensor.Sensor X.Range.Scale</b> is set to <b>Logarithmic</b>
<b>Actual Logarithmic Values</b>	Shows the logarithmic value. Full Scale is <b>Upper Limit Value</b>

EXAMPLE:

Sensor 1 linear 1000Torr, Sensor 2 linear 10Torr

With these sensors the measuring range is: 0.001Torr ... 1000Torr, so we cover 6 decades

<b>Percent Per Decade</b>	15 With 15% we cover 6.6 decades (100/15 = 6.6)														
<b>Lowest Pressure</b>	0.001Torr (~1mV of Low Sensor)														
<b>Upper Limit Value</b>	Shows 1000 (because SFS is 1000)														
<b>Actual Logarithmic Value</b>	Torr														
Example Values	<table border="0"> <tr><td>1000</td><td>1000</td></tr> <tr><td>850</td><td>100</td></tr> <tr><td>700</td><td>10</td></tr> <tr><td>550</td><td>1</td></tr> <tr><td>400</td><td>0.1</td></tr> <tr><td>250</td><td>0.01</td></tr> <tr><td>100</td><td>0.001</td></tr> </table>	1000	1000	850	100	700	10	550	1	400	0.1	250	0.01	100	0.001
1000	1000														
850	100														
700	10														
550	1														
400	0.1														
250	0.01														
100	0.001														
<b>Pressure On Interface</b>	Linear We want the logarithmic signal only on the pressure controller but not on the interface.														
<b>Use Logarithmic Sensor</b>	False Since the sensor signal is linear, there is no possibility to use a logarithmic signal from the sensor.														

Application: Soft Pump

Use of **Actual Logarithmic Value** in the pressure controller: Set **Pressure Control.Controller X.Control Settings.Pressure Scaler** to **Logarithmic**.

**Note:** Ramp value use logarithmic signal too, so **Ramp.Slope** is related to logarithmic scale.

For above example: **Slope [Torr]** = 15 means 15 of 1000 per Second what is 1.5% what corresponds to 0.15 Decade per Second.

## 4.14 Power Connector Digital IO



Do not connect other pins than indicated in the schematics!  
Use only screws with 4-40UNC thread for fastening the DA-15 connector!

### 4.14.1 Digital Input

#### 4.14.1.1 Connection

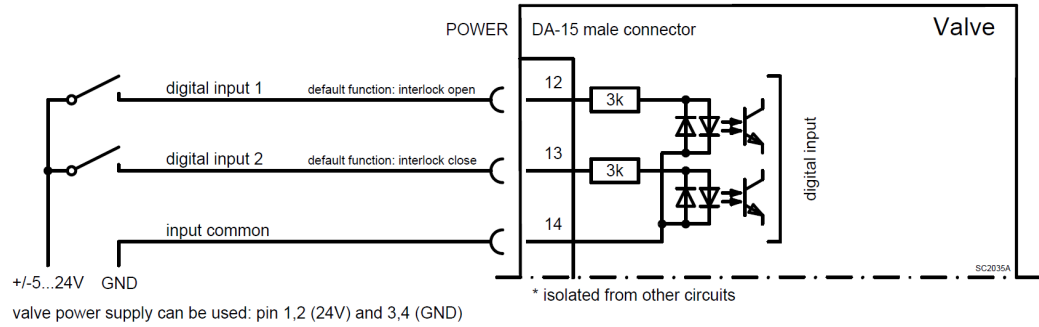

Pin	Default Function
12	<b>INPUT 1</b> Interlock Open
13	<b>INPUT 2</b> Interlock Close
14	<b>COMMON</b>

#### 4.14.1.2 Configuration

Location: CPA/Navigation/Parameters: Power Connector IO.Digital Input

Parameter	Description													
<b>Enable</b>	1 enables the input													
<b>State</b>	0 Not active 1 Active													
<b>Functionality</b>	0 Interlock Open 1 Interlock Close 2 Hold													
<b>Inverted</b>	<table border="1"> <thead> <tr> <th>Input</th> <th>State</th> <th>Function</th> </tr> </thead> <tbody> <tr> <td rowspan="2">0 Not Inverted</td> <td>Off</td> <td>0 Off</td> </tr> <tr> <td>On</td> <td>1 On</td> </tr> <tr> <td rowspan="2">1 Inverted</td> <td>Off</td> <td>1 Off</td> </tr> <tr> <td>On</td> <td>0 On</td> </tr> </tbody> </table>	Input	State	Function	0 Not Inverted	Off	0 Off	On	1 On	1 Inverted	Off	1 Off	On	0 On
Input	State	Function												
0 Not Inverted	Off	0 Off												
	On	1 On												
1 Inverted	Off	1 Off												
	On	0 On												



The INTERLOCK function has **priority** over the remote interface (HOLD does not)  
INTERLOCK CLOSE has **priority** over INTERLOCK OPEN

### 4.14.2 Digital Output

#### 4.14.2.1 Connection

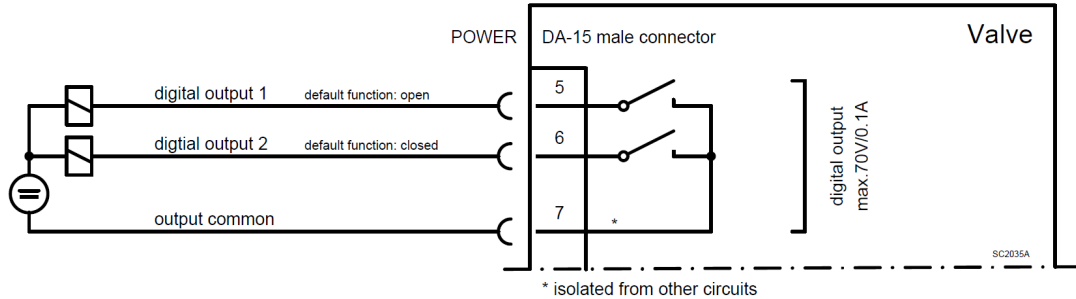

Pin	Default Function
5	<b>OUTPUT 1</b> Open
6	<b>OUTPUT 2</b> Closed
7	<b>COMMON</b>

#### 4.14.2.2 Parameter, Configuration

Location: CPA/Navigation/Parameters: Power Connector IO.Digital Output

Parameter	Description																		
<b>Enable</b>	<b>1</b> enables the output																		
<b>State</b>	<b>0</b> Not active <b>1</b> Active																		
<b>Functionality</b>	<b>0</b> OPEN valve is fully open <b>1</b> CLOSE valve is fully closed (isolated if valve has an isolation function) <b>2</b> HOLD valve is in hold state																		
<b>Inverted</b>	<table border="1"> <thead> <tr> <th></th> <th>Function</th> <th>State</th> <th>Output</th> </tr> </thead> <tbody> <tr> <td rowspan="2"><b>0</b> Not Inverted</td> <td>inactive</td> <td>0</td> <td>Off</td> </tr> <tr> <td>active</td> <td>1</td> <td>On</td> </tr> <tr> <td rowspan="2"><b>1</b> Inverted</td> <td>inactive</td> <td>1</td> <td>On</td> </tr> <tr> <td>active</td> <td>0</td> <td>Off</td> </tr> </tbody> </table>		Function	State	Output	<b>0</b> Not Inverted	inactive	0	Off	active	1	On	<b>1</b> Inverted	inactive	1	On	active	0	Off
	Function	State	Output																
<b>0</b> Not Inverted	inactive	0	Off																
	active	1	On																
<b>1</b> Inverted	inactive	1	On																
	active	0	Off																

## 5 Operation



### **WARNING**

#### **Unqualified personnel**

Inappropriate handling may cause serious injury or property damage.  
Only qualified personnel are allowed to carry out the described work.



### **WARNING**

#### **Valve opening**

Risk of serious injury.  
Human body parts must be kept out of the valve opening and away from moving parts.  
Do not connect the controller to power before the valve is installed complete into the system.

## 5.1 Access Mode

### 5.1.1 Overview

Defines whether the interface or the CPA via the service port has the rights to control the valve  
*Location: CPA/Parameters System*

Access Mode	Control Permission	Comment
Local	CPA	
Remote	INTERFACE Master	CPA can switch to Local
Locked	INTERFACE Master	CPA can't switch to Local



Power On state is 'Remote'

### 5.1.2 Remote and Locked operation

This product is equipped with an interface to allow for remote operation.  
 See section «Interface» for details.

'Control Performance Analyzer' software may be used for monitoring during remote control.



In case 'Control Performance Analyzer' is used, make sure 'Remote' button is pushed to enable for remote operation.

### 5.1.3 Local operation

Local operation means that the valve is operated via the service port using a computer.  
 You can use our software 'Control Performance Analyzer' for Local operation, which is integrated in the controller. The software is beneficial especially for setup, testing and maintenance.

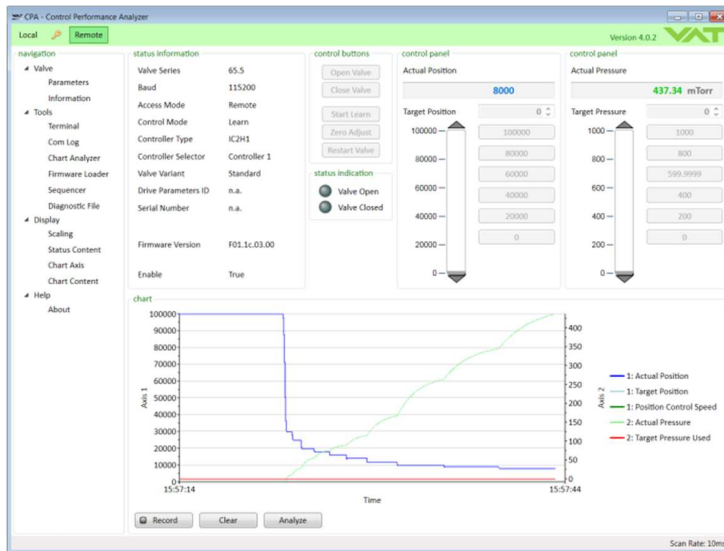

When communication to service port is interrupted the valve will change to remote operation. So when service cable will be disconnected or software will be shut down, the valve returns automatically to remote operation. This may result in an **immediate movement** of the valve depending on remote control.

## 5.2 Control Mode

The **Control Mode** represents the state machine of the valve. Writing to **Control Mode** requests a change in the state while reading **Control Mode** returns the actual state of the state machine.

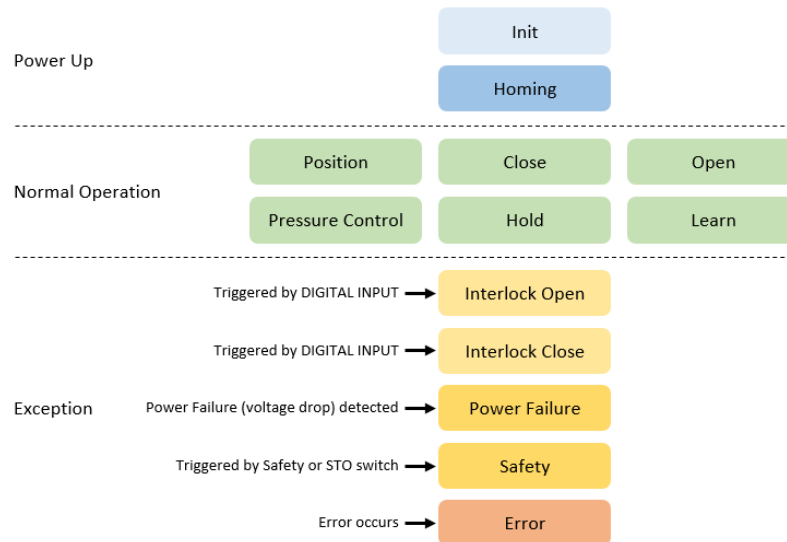

<b>Init</b>	<b>State after power up. Remains if Homing is not started or no Exception occurs</b>
<b>Homing</b>	The valve performs the homing procedure to initialize the position. Refer to chapter Homing
<b>Position</b>	The valve moves to the desired <b>Target Position</b> .
<b>Close</b>	The valve closes.
<b>Open</b>	The valve opens.
<b>Pressure Control</b>	The valve controls to the desired <b>Target Pressure</b> . Refer to chapter Pressure Control
<b>Hold</b>	The valve remains in the actual position. Usage during Pressure Control: Reduce valve reaction during plasma ignition. Stopping the valve movement to evaluate the stability of the sensor, flow meter, ... Note: Change from <b>Control Mode Close</b> to <b>Hold</b> is not possible
<b>Learn</b>	The valve performs the system learn. Necessary for Adaptive Pressure Control. Refer to chapter Pressure Control/Adaptive Algorithm/Learn
<b>Interlock Open</b>	The valve opens and locks due to the actuation of a digital input. Release behavior: <b>Control Mode</b> changes to <i>Open</i> or to <i>Init</i> if no Homing was performed yet. Refer to Chapter Power IO
<b>Interlock Close</b>	The valve closes and locks due to the actuation of a digital input. Release behavior: <b>Control Mode</b> changes to <i>Close</i> or to <i>Init</i> if no Homing was performed yet. Refer to Chapter Power IO
<b>Power Failure</b>	Power loss occurred. The valve opens or closes (Only with optional Power Failure Option) Closing or opening behavior depends on set <b>Power Failure.Functionality</b> Refer to chapter Power Failure
<b>Safety</b>	The motor of the valve is powerless due to a digital input. Release behavior: <b>Control Mode</b> changes to <i>Init</i> Refer to chapter xxx
<b>Error</b>	The valve is in an error state, no movement possible. Recovery via <b>Services.Error Recovery</b> or <b>Services.Restart Controller</b> . Refer to chapter Trouble Shooting.

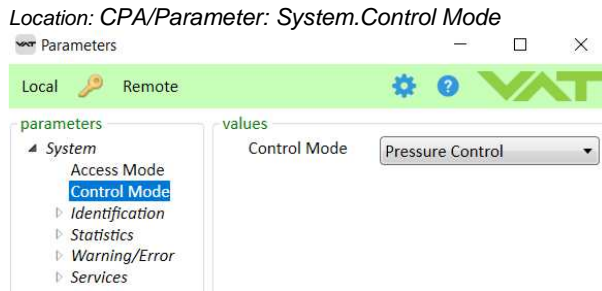

5.2.1 View

CPA

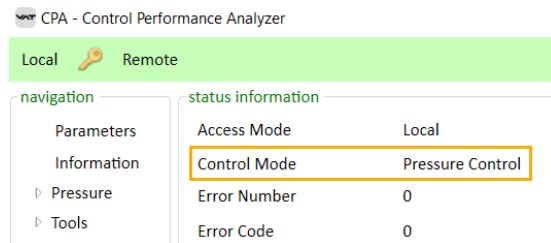

First digit on display



- I Init
- H Homing
- C Close
- O Open
- P Pressure Control
- A Position
- I Interlock Open or Close
- H Hold
- L Learn
- S Safety Mode
- F Power Failure
- E Error



## 5.3 Pressure Control

### 5.3.1 Controller units

The valve has four identical pressure controller units. **Controller Selector** defines which unit is used for the pressure control.

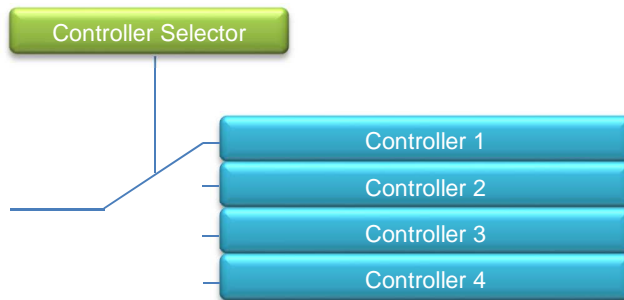

Most applications do not need more than one controller unit. But if the result of the pressure control does not meet the expectations, different controller units can be an option for optimization: With the four controller units it is possible to use a certain controller unit for a specific pressure set point. This controller unit can be parametrized optimally for this specific set point. With the **Automated Controller Selector** (see below) it is possible to change Controller depending on pressure ranges or on up- and down control.

The CPA window 'Pressure Control' shows an good overview of the control units and their features:

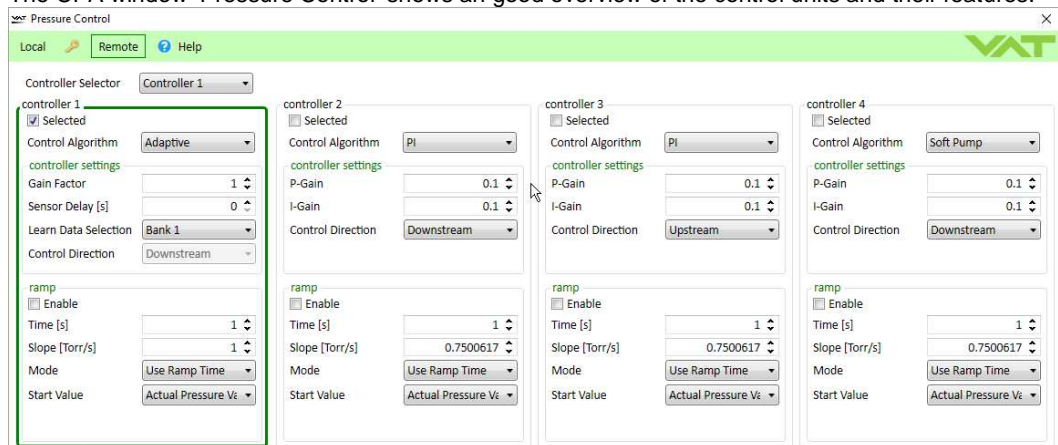

## 5.3.2 Control algorithm

### 5.3.2.1 Overview

**Adaptive** This is the most dynamic control algorithm. Before using adaptive control algorithm, a special procedure called “learn” must be executed first (see chapter below). The valve will observe the behavior of the vacuum system by moving the valve to different positions. During the learn procedure the valve performs an internal parameter estimation correspondent to the vacuum system.

Note: Adaptive control algorithm requires a **linear** sensor signal. If a logarithmic sensor is used the signal has to be linearized or PI algorithm has to be used.

**PI** This is a solid algorithm for pressure control. The performance will be behind the adaptive control algorithm. But if the condition varies a lot, it's possible that the adaptive control algorithm does not work properly so the PI algorithm provides the best result.

**Soft Pump/Vent** Is a modified PI control algorithm to pump down from atmospheric pressure or vent to atmospheric pressure. This control algorithm has been optimized to starts very carefully when opening the valve.

5.3.2.2 Choose correct control algorithm

System Configuration	Constant gas flow available		Constant gas flow not available
	Tv* <= 500 sec	Tv* > 500 sec	
<p><b>Downstream</b></p>	<b>Adaptive</b>		<b>PI</b>
<p><b>Upstream</b></p>			<b>PI</b>
<b>Soft Pump</b>	<b>Soft Pump</b>		

\* Use the formula below to define the applicable pressure control algorithm.

$$T_v = \frac{p_{SFS} \cdot CV}{q_L}$$

- q<sub>L</sub>** gasflow for learn [mbar/s]
- p<sub>SFS</sub>** sensor full scale pressure [mbar]
- Tv\*** Vacuum time constant [sec]
- CV** Chamber Volume [l]

### 5.3.3 Adaptive algorithm

This control algorithm may be used for downstream pressure control.

Before using adaptive control algorithm, a special procedure called “learn” must be executed first (see chapter below).

#### 5.3.3.1 Control Parameter

*Location: CPA/Navigation/Parameters: Pressure Control.Controller x.Control Settings*

Parameter	Description
<b>Gain Factor</b>	Main parameter to adapt the performance of the pressure control algorithm. A higher gain results in a faster response, higher over- / undershoots of pressure. A lower gain results in slower response, lower over- / undershoot of pressure.
<b>Sensor Delay</b>	For compensation of delays during the pressure detection. Pipes and orifices for sensor attachment can cause delays in response time and could impact badly the pressure control stability. By adapting this parameter to the approximate delay time stability problems can be reduced. But control response time will be slowed down by this measure.
<b>Learn Data Selection</b>	There are up to 4 different learn data sets available. Select which Learn data set the adaptive controller shall use for pressure control.
<b>Ramp</b>	A set poin ramp can be use to avoid over shoots... See chapter «Pressure Ramp»

5.3.3.2 Learn

LEARN adapts the PID controller of the valve to the vacuum system and its operating conditions. LEARN must be executed only once during system setup. The LEARN routine determines the characteristic of the vacuum system. Based on this, the PID controller is able to run fast and accurate pressure control cycles.

This characteristic depends on various parameters such as chamber volume, conductance and flow regime. Therefore it must be performed with a specific gas flow according to instruction below. The result of LEARN is a pressure versus valve position data table. This table is used to adapt the PID parameters. The data table is stored in the device memory which is power fail save. The data table can be up-/downloaded via 'Control Performance Analyzer' software or remote interface. Due to encoding the data may not be interpreted directly. By an OPEN VALVE, CLOSE VALVE, POSITION CONTROL or PRESSURE CONTROL command the routine will be interrupted.

Recorded Standard Learn

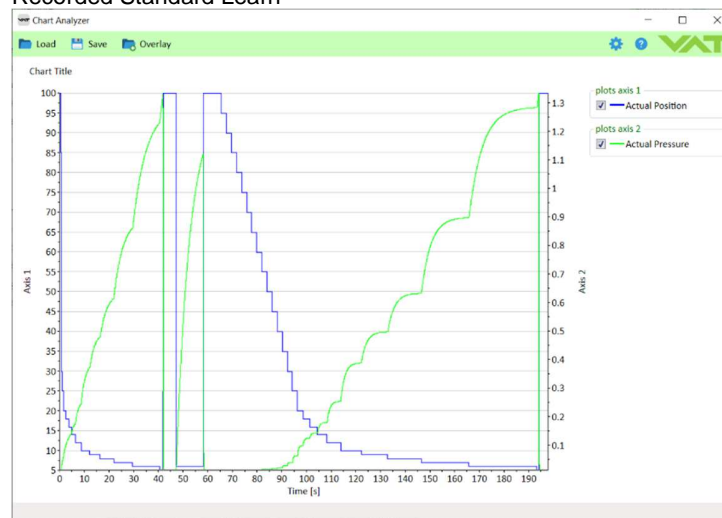

Resulting Learn Data



**Parameters Executing**

*Location: CPA/Navigation/Parameters: Pressure Control.Adaptive Learn*

Parameter	Description
<b>Start Learn</b>	Starts the learn
<b>Type</b>	<p>Standard     A positioning sequence is executed and various measured values are recorded in the process.</p> <p>Short         Opens the valve and measures the pumping speed. Information about flow and volume is required.</p> <p>Calculated    Calculated the learn data with the pumping speed information.</p> <p>Short or Calculated can be used when there is no way to set a constant gas flow.</p>
<b>Bank Selection</b>	Select one of four learn bank to place the result of the learn procedure. Note: Be sure pressure controller select this learn bank!
<b>Pressure Limit [SFS]</b>	Limit pressure to which pressure the learn shall be executed. The value is related to the sensor full scale of high sensor. 1.0 means the whole pressure range of the sensors
<b>Pressure Limit</b>	Same value as above but in Pressure Unit
<b>Open Speed</b>	Define the speed for opening the valve during the learn procedure. May be necessary to prevent a pump from crashing. 1.0 means full speed
<b>Status</b>	State of the current learn <b>0:</b> Not Started <b>1:</b> In Progress <b>2:</b> Completed Successfully <b>3:</b> Aborted <b>4:</b> Failed
<b>Warning Info</b>	Warning of current learn procedure: Bit <b>0:</b> Learn is running Bit <b>1:</b> Checksum error (learn data corrupt) Bit <b>2:</b> Learn procedure terminated by user Bit <b>3:</b> Pressure at position open > 50% of pressure limit Bit <b>4:</b> Pressure at minimal conductance position < 10 % of pressure limit Bit <b>5:</b> Pressure falls while move valve in direction of close Bit <b>6:</b> Pressure at open position does not match pressure of previous open Bit <b>7:</b> Learn procedure terminated by program Bit <b>8:</b> Pressure <= 0 at open position (no gas flow set?)

Sort Learn Parameter

Parameter	Description
<b>Chamber Volume</b>	Volume above the valve plate in Liter
<b>Gas Flow</b>	Gas flow during the short learn, must be constant during the short learn
<b>Gas Flow Unit</b>	Gas flow unit for above Gas Flow
<b>Pumping Speed</b>	Resulting pumping speed

Calculated Learn Parameter

Parameter	Description
<b>Pumping Speed</b>	Set pumping speed to calculate the learn data

### Parameters Learn Bank

*Location: CPA/Navigation/Parameters: Pressure Control.Adaptive Learn.Learn Bank x*

Parameter	Description
<b>Status</b>	<p>Not Used Available</p> <p>Empty learn bank Data available. Evaluation possible with the pressure position curve in the CPA/Navigation/Adaptive Learn Data</p> <p>Available with warnings</p> <p>The data may still be suitable for pressure control. Evaluation possible with the pressure position curve in the CPA/Navigation/Adaptive Learn Datas</p>
<b>Data</b>	Captured data in a non-readable format
<b>Warning Info</b>	Displays warnings that occurred while learning for this learning bank. Show Warning Info above
<b>Type</b>	<p>Standard Short Calculated ..See description above</p>
<b>Delete Learn Bank Data</b>	Deletes the data of the learn bank

**Execute a learn procedure**

1. Set specific gas flow according to calculation below or the calculation in the CPA → **'Adaptive Learn'** window:  
  
Learn does not need to be performed with the process gas. Instead N<sub>2</sub> or Ar may be used.
2. Set parameter **Bank Selection**, if only one learn is used take Bank 1. Be sure that the pressure controller also selects this learn bank!
3. Reduce **Open Speed** if it is critical for the chamber if the pressure drops rapidly when the valve is opened.
4. Set a **Pressure Limit [SFS]** limit if sensor full scale cannot or should not be reached.
5. Set parameter **Controller Mode** to **LEARN**.
6. Wait until the **Controller Mode** leaves the **LEARN** state → Learn is finished
7. Check if the learn was successful by checking if **Status** shows value 2 (=Completed Successfully). In best case **Warning Info** shows no warning.



- ➔ Sensor signal must not shift during LEARN. Wait until sensor signal is stable before LEARN is performed. Learn may take several minutes.
- ➔ Do not interrupt the routine as a single full run is required to ensure fast and accurate pressure control.
- ➔ The PID controller covers 5% to 5000% of the gas flow which was used for learn.

CPA window **'Adaptive Learn'**

Local Remote Help

**valve type**

Valve Series:

Valve Variant:

Nominal Diameter:

Min Conductance [l/s]:  edit

---

**learn limits**

Pressure Limit [mTorr]:

Open Speed:

Bank Selection:

---

**working point table**

Gas Flow Unit:

Pressure [mTorr]	Gas Flow [sccm]	Conductance [l/s]
100	250	31.67
80	80	12.67

---

**learn process sequence**

Recommended Gas Flow [sccm]:

Not Started

---

**learn data**

Adaptive Learn Data



### Gasflow calculation for Learn



Do not apply a different gasflow for learn than determined below. Otherwise pressure control performance may be insufficient. Required pressure / flow regime must be known to calculate the most suitable learn gas flow for a specific application.

**Note:** The subsequent calculation can be conveniently performed in the CPA/Navigation/Adaptive Learn > Gas Flow Calculation > Calculate

- At first it is necessary to find out about the required control range respectively its conductance values. Each working point (pressure / flow) must be calculated with one following formulas. Choose the applicable formula depending on units you are familiar with.

$$C_{WP} = \frac{1000 \cdot q_{WP}}{p_{WP}}$$

$C_{WP}$  required conductance of working point [l/s]  
 $q_{WP}$  **gasflow** of working point [Pa m<sup>3</sup>/s]  
 $p_{WP}$  **pressure** of working point [Pa]

$$C_{WP} = \frac{q_{WP}}{p_{WP}}$$

$C_{WP}$  required conductance of working point [l/s]  
 $q_{WP}$  **gasflow** of working point [mbar l/s]  
 $p_{WP}$  **pressure** of working point [mbar]

$$C_{WP} = \frac{q_{WP}}{78.7 \cdot p_{WP}}$$

$C_{WP}$  required conductance of working point [l/s]  
 $q_{WP}$  **gasflow** of working point [sccm]  
 $p_{WP}$  **pressure** of working point [Torr]

- Out of these calculated conductance values choose the lowest.

$$C_R = \min(C_{WP1}, C_{WP2}, \dots, C_{WPn})$$

$C_R$  required lower conductance [l/s]  
 $C_{WPx}$  required conductance of working points [l/s]



To make sure that the valve is capable to control the most extreme working point verify that  $C_R \geq C_{min}$  of the valve (refer to «Technical data»).

- Calculate gasflow for learn. Choose the applicable formula depending on units you are familiar with.

$$q_L = \frac{p_{SFS} \cdot C_{min}}{1100}$$

$q_L$  gasflow for learn [Pa m<sup>3</sup>/s]  
 $p_{SFS}$  sensor full scale pressure [Pa]  
 $C_{min}$  min. controllable conductance of valve [l/s], (refer to «Technical data»)

$$q_L = \frac{p_{SFS} \cdot C_{min}}{1.1}$$

$q_L$  gasflow for learn [mbar l/s]  
 $p_{SFS}$  sensor full scale pressure [mbar]  
 $C_{min}$  min. controllable conductance of valve [l/s], (refer to «Technical data»)

$$q_L = 71 \cdot p_{SFS} \cdot C_{min}$$

$q_L$  gasflow for learn [sccm]  
 $p_{SFS}$  sensor full scale pressure [Torr]  
 $C_{min}$  min. controllable conductance of valve [l/s], (refer to «Technical data»)

**Evaluation and exchange of learn data**

*Location: CPA/Navigation/Adaptive Learn Data*

The window shows the pressure position curve of the stored data in the learning banks  
 With the menu buttons it is possible to exchange data between learn banks and between valves.



### 5.3.3.3 Tuning

Normally the default settings will result in good pressure control performance. For some applications tuning may be required to improve performance. The tuning procedures for each parameter (grey boxes) and its default values are described separately below. Strictly keep the procedure order.

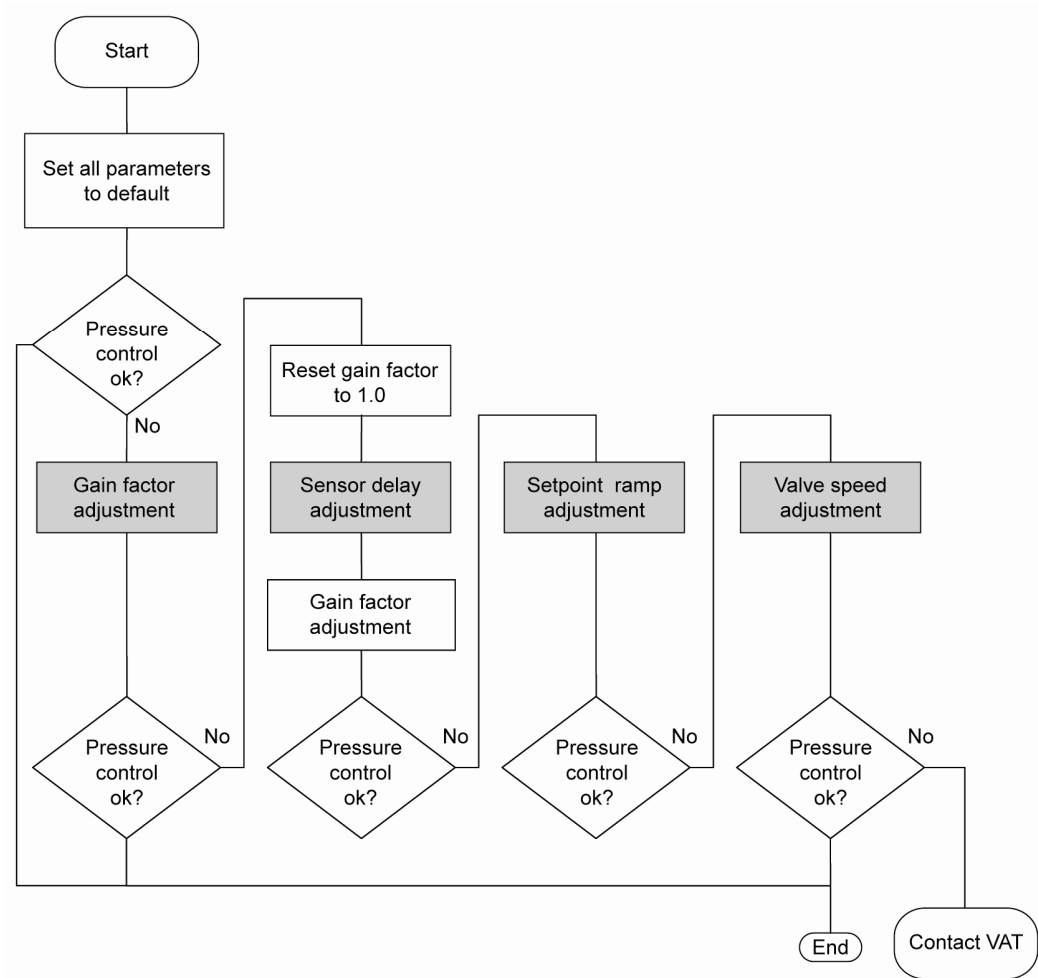

## Gain Factor adjustment

The Gain Factor effects: **Stability, Response time**

Adjustment range is from 0.0001 to 100.0

- Higher gain results in: faster response, higher over- undershoot of pressure
- Lower gain results in: slower response, lower over- undershoot of pressure

Adjustment procedure:

1. Start with Gain Factor 1.0
2. Open valve.
3. Control a typical pressure / flow situation.
4. Repeat from step 2 with lower (higher) Gain Factors until optimal pressure response is achieved and stability is ok.



Normally adjustments down to Gain Factors of 0.1 should lead to good results. Otherwise you may need to improve sensor connection. Refer to «Requirements to sensor connection».

## Sensor Delay adjustment

Sensor Delay adjustment effects: **Stability**

Adjustment range is from 0.0 to 1.0sec

Pipes and orifices for sensor attachment delay response time and so badly impact pressure control stability.

By adapting this parameter to the approximate delay time stability problems can be reduced. But control response time will be slowed down by this measure.



Whenever possible sensors should be attached to the chamber according to «Requirements to sensor connection». This is the most effective measure against stability issues. If your gauge attachment fulfills these criteria do not use this parameter.

Adjustment procedure:

1. Start with Gain Factor 1.0 and sensor delay 0s.
2. Open valve.
3. Control a typical pressure / flow situation.
4. Repeat from step 2 with higher sensor delays until best possible stability is achieved.
5. Adjustment Gain Factor again. Refer to «Gain factor adjustment».

### Setpoint Ramp adjustment

Setpoint Ramp effects: **Undershoot of pressure, Response time**

Note: The ramp is described in detail in capital Pressure Ramp.

This parameter defines the time that is used to decrease / raise pressure between 2 setpoints. Especially in pressure decrease situations at low flows pressure response can be improved much by adapting setpoint ramp time.

#### Pressure chart

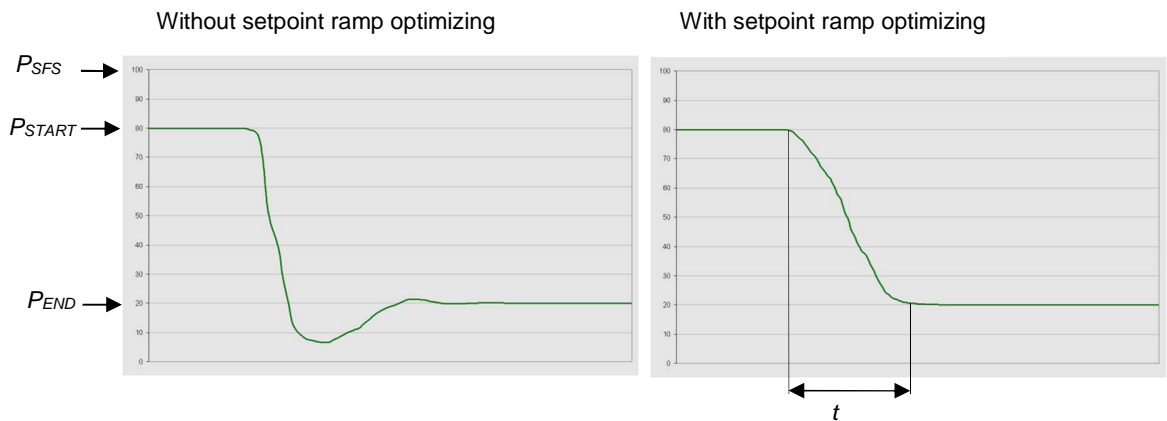

Choose the applicable formula depending on units you are familiar with.

$t$	-	Setpoint Ramp
$P_{SF5}$	-	Pressure at Sensor full scale
$P_{START}$	-	Pressure at start of controlling a pressure step
$P_{END}$	-	Certain pressure, which should be regulated

Adjustment procedure:

1. Start with optimal Gain Factor and sensor delay time according to preceding tuning steps.
2. Control a typical pressure / flow situation.
3. Control a lower pressure.
4. Repeat from step 2 with longer setpoint ramps until best response is achieved.
5. Verify pressure control response for a setpoint raise situation.



In case a long ramp time is required to get optimal performance for pressure decrease situations it may be of advantage to apply different settings for decrease / raise control situations.

## Pressure Control Speed adjustment

Valve speed effects: **Response time**

Adjustment range is from 0.001 to 1.0  
Default value is 1.0

Location: CPA/Navigation/Parameters: Pressure Control.Pressure Control Speed

This parameter effects valve plate actuating speed.  
Speed adjustment is effective for PRESSURE CONTROL and POSITION CONTROL.



Normally best pressure control response is achieved with maximum Pressure Control Speed. In particular applications it may be of advantage to have a slower valve response.  
OPEN and CLOSE are always done with maximum speed.

Adjustment procedure:

1. Use optimal Gain Factor, sensor delay time and setpoint ramp according to preceding tuning steps.
2. Open valve.
3. Control a typical pressure / flow situation.
4. Repeat from step 2 with slower Pressure Control Speed until required response is achieved.

Required information for support:

- Go to 'Tools / Create Diagnostic File' in 'Control Performance Analyzer' and save file
- Pressure / flow / gas conditions to be controlled
- Chamber volume
- Pumping speed (l/s) and pump type (e.g. turbo pump)
- System description
- Problem description

Send diagnostic file with and all required information to [tuning-support@vat.ch](mailto:tuning-support@vat.ch)

### 5.3.4 PI algorithm

This control algorithm may be used for downstream or upstream pressure control depending on configuration.

#### 5.3.4.1 Control Parameter

*Location: CPA/Navigation/Parameters: Pressure Control.Controller x,Control Settings*

Parameter	Description
<b>P-Gain</b>	The <b>P-Gain</b> is the proportional factor of the fixed control algorithm. A higher P-Gain results in faster response, higher over- / undershoot of pressure.
<b>I-Gain</b>	The <b>I-Gain</b> is the integral factor. The <b>I-Gain</b> helps to reach the target pressure exactly.
<b>Pressure Scale</b>	Linear Logarithmic    Recommended if the pressure control extends over several decades. In most cases, the sensor used is a logarithmic sensor anyway.
<b>Direction</b>	The <b>Control Direction</b> defines the type of application, if the valve is mounted in downstream or upstream. Downstream means the valve is after the chamber and before the pump. Upstream, valve is mounted before chamber and pump.

### 5.3.4.2 Tuning

The PI parameters of the pressure controller require correct adjustment. These parameters must be set once during system setup and are stored in the device memory which is power fail save. Based on the PI controller configuration, the valve is able to run fast and accurate pressure control cycles. The PI parameters can be evaluated using below instruction.



- In downstream control mode valve will move towards open when current pressure is higher than set point.
- In upstream control mode valve will move towards close when current pressure is higher than set point.

#### Introduction

PI controller mode is used if for any reason (e.g. too long system time constant) the adaptive control mode does not provide satisfying control performance.

In PI controller mode the parameters P-Gain and I-Gain have to be set according to the systems characteristics. The best set of parameters can be found by using the empiric method below.

#### Pressure and gas flow for optimization

A PI controller delivers the best results for a certain working point (pressure/gas flow). If there is only one working point, this pressure and gas flow has to be used for optimizing P and I-Gain. If there are several working points that have to be covered, the pressure for optimizing is the medium pressure between highest and lowest pressure to be controlled, the gas flow for optimizing is the highest flow out of all working points.

Two different pressure set points are necessary for optimization.

Set point 1 (SP1) is the pressure for optimizing as determined above.

Set point 2 (SP2) is about 10 - 20% lower than SP1.

Example: pressure range: 4 – 10 Torr

Flow range: 2 – 4 slm

Pressure set points and gas flow for optimization:

SP1 = 7 Torr

SP2 = 6 Torr

Gas flow = 4 slm



### Optimizing P-Gain

While optimizing P-Gain, the gas flow determined above has to be constant all the time.

Start optimization with P-Gain set to 1.0 and I-Gain set to 0.0.

Set chamber pressure to SP2, wait until the pressure is stable. Set pressure to SP1. If the transition from SP2 to SP1 results in a significant pressure over shoot or even does not stabilize at all, the P-Gain is too high. If there is no over shoot and the pressure reaches SP1 asymptotically and very slow, P-Gain is too low.

The optimal P-Gain value is found if the transition from SP2 to SP1 results in a slight pressure over shoot. It does not matter if there is still a deviation between SP1 and actual pressure.

Example:

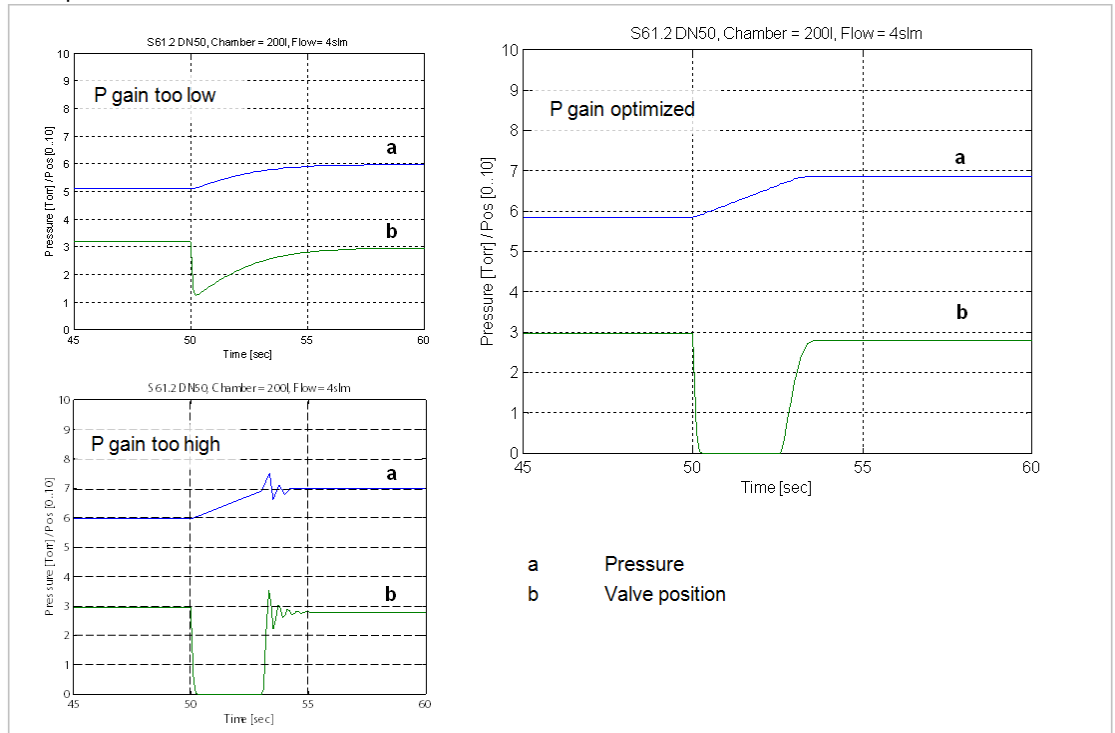

### Optimizing I-Gain

While optimizing I-Gain, the gas flow determined above has to be constant all the time.

Start with P-Gain set to half of the value found when optimizing P-Gain and set I-Gain to 1.0. Keep the P-Gain constant.

Set chamber pressure to SP2, wait until the pressure is stable. Set pressure to SP1. If the transition from SP2 to SP1 results in a significant pressure overshoot or if the valve position does not stabilize, I-Gain is too high. If the transition results in a slow asymptotical pressure rise and there is still a constant deviation to SP2, the I-Gain is too low.

The optimal value for I-Gain is found if the transition from SP2 to SP1 result in just a slight pressure overshoot, a stable valve position and the actual pressure matches SP2 exactly.

Example:

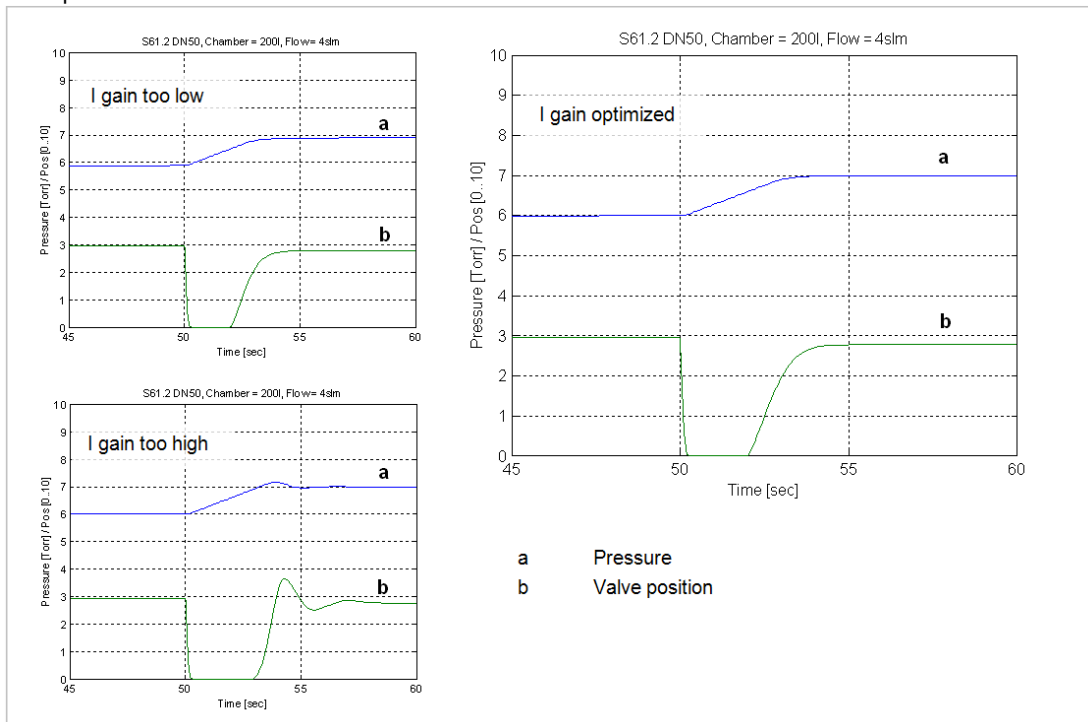

**Check control performance over the whole control range with parameters above.**

Required information for support:

- Go to 'Tools / Create Diagnostic File' in 'Control Performance Analyzer' and save file
- Pressure / flow / gas conditions to be controlled
- Chamber volume
- Pumping speed (l/s) and pump type (e.g. turbo pump)
- System description
- Problem description

Send diagnostic file with and all required information to [tuning-support@vat.ch](mailto:tuning-support@vat.ch)

### 5.3.4.3 Soft Pump/Vent algorithm

This control algorithm may be used to control pressure ramps during pump down or venting the chamber. This is a modified PI controller that has been optimized to start up very gently when the valve is opened.

### 5.3.4.4 Control Parameter

*Location: CPA/Navigation/Parameters: Pressure Control.Controller x,Control Settings*

Parameter	Description
<b>P-Gain</b>	The <b>P-Gain</b> is the proportional factor of the fixed control algorithm. A higher P-Gain results in faster response, higher over- / undershoot of pressure.
<b>I-Gain</b>	The <b>I-Gain</b> is the integral factor. The <b>I-Gain</b> helps to reach the target pressure exactly.
<b>Pressure Scale</b>	Linear Logarithmic    Recommended if the pressure control extends over several decades. In most cases, the sensor used is a logarithmic sensor anyway.
<b>Direction</b>	The <b>Control Direction</b> defines the type of application, if the valve is mounted in downstream or upstream. Downstream means the valve is after the chamber and before the pump. Upstream, valve is mounted before chamber and pump.
<b>Ramp</b>	Only the ramp makes the soft pump or soft vent... See chapter «Pressure Ramp»

### 5.3.4.5 Tuning

#### Optimizing P-Gain

Start optimization with P-Gain set to 0.1 and I-Gain set to 0.0.

The control routine has to be controlled as follows:

- Move control valve into close position
- Start pump down by opening the pump isolation valve or starting the pump
- Send the pressure set point to the valve controller.

While pumping/venting the chamber pressure and valve position should be data logged to compare the actual curve with the ideal straight pump/venting line.

If the pressure follows the ideal pump/venting line with significant delay, the P-Gain is too low.

If the pressure oscillates around the ideal pump/venting line or if the valve position oscillates, P-Gain is too high.

P-Gain is optimized if the pressure follows the ideal pump down line closely and the valve position is not oscillating at all.

### Optimizing I-Gain

Start with P-Gain set to half of the value found when optimizing P-Gain and set I-Gain to 1.0. Keep the P-Gain constant.  
 If the pressure follows the ideal pump/venting line with significant delay, the I-Gain is too low.  
 If the pressure oscillates around the ideal pump/venting line or if the valve position oscillates, I-Gain is too high.

I-Gain is optimized if the pressure follows the ideal pump down line closely and the valve position is not oscillating at all.

Example:

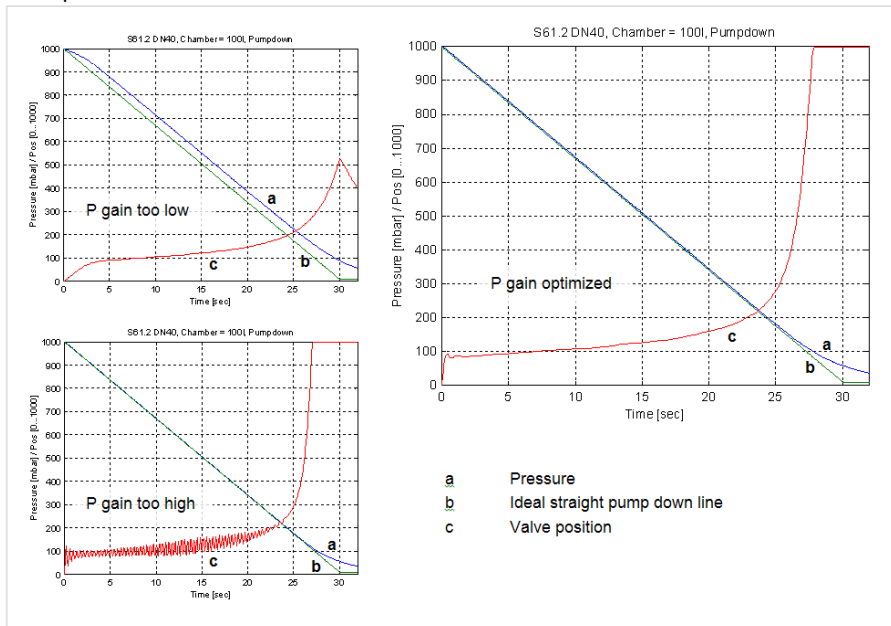

### Optimizing I-Gain

I-Gain is responsible to reach the setpoint. If reaching setpoint is not important (e.g. setpoint is 0) leave the I-Gain at 0. Otherwise start with P-Gain set to half of the value found when optimizing P-Gain and set I-Gain to 0.1. Keep the P-Gain constant. Start again the pump down. Check how the pressure reaches the setpoint:

If the setpoint is reached too slowly increase I-Gain  
 If there is an undershoot increase I-Gain

Required information for support:

- Go to 'Tools / Create Diagnostic File' in 'Control Performance Analyzer' and save file
- Pressure / flow / gas conditions to be controlled
- Chamber volume
- Pumping speed (l/s) and pump type (e.g. turbo pump)
- System description
- Problem description

Send diagnostic file with and all required information to [tuning-support@vat.ch](mailto:tuning-support@vat.ch)

### 5.3.5 Pressure Ramp

Basically, the pressure ramp is used to limit the rate of pressure change.

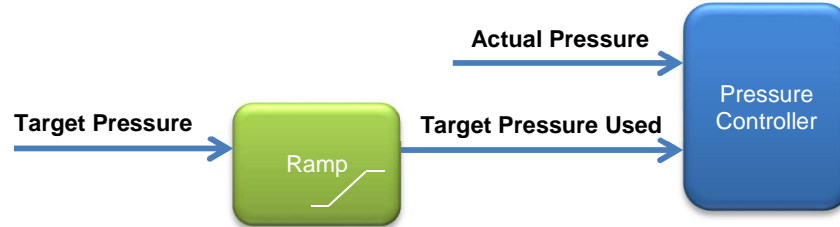

#### 5.3.5.1 Configuration

*Location: CPA/Navigation/Parameters: Pressure Control.Controller x.Ramp*

Parameter	Description
<b>Enable</b>	Activate / Deactivate pressure target ramp
<b>Mode</b>	0:Use <b>Ramp Time</b> 1:Use <b>Ramp Slope</b> <span style="float: right;">See description below</span>
<b>Time</b>	Target reach time in seconds (Used if <b>Mode</b> = 0)
<b>Slope</b>	Limit the rate of pressure change in pressure per seconds (Used if <b>Mode</b> = 1)
<b>Type</b>	0:Linear 1:Logarithmic 2:Exponential
<b>Start Value</b>	0:Previous Ramp Value 1:Actual Pressure Value

5.3.5.2 Mode

**Time**

Unit: seconds

Time is constant, slope varies

Example: 2 sec

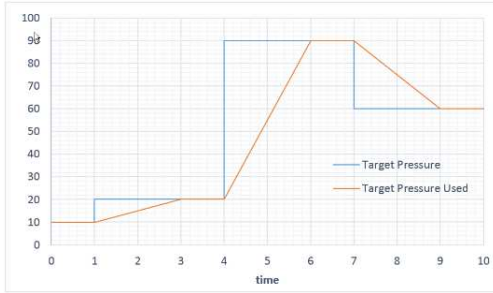

**Slope**

Unit: Pressure / seconds

Slope is constant, time varies

Example: 10mTorr/second

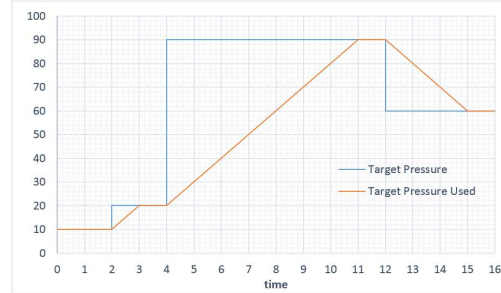

5.3.5.3 Type

**Linear**

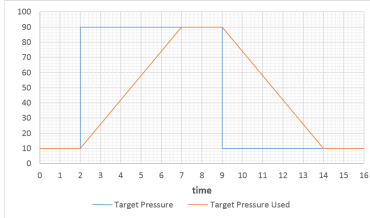

**Logarithmic**

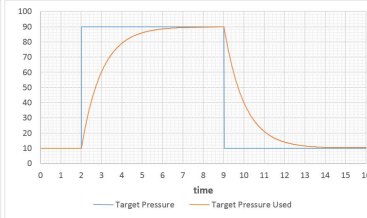

**Exponential**

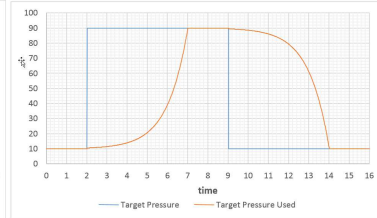



**5.3.5.4 Applications Examples**

**Soft pump**

Ramp Mode = Time  
 Ramp Time = 100 sec  
 Ramp Type = Linear  
 Target Pressure = 0

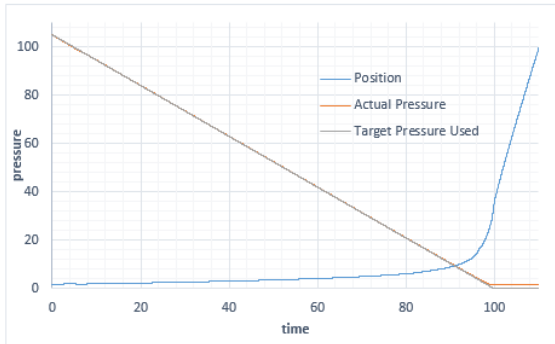

**Minimize pressure over- or undershoots**

New Target Pressure without pressure ramp

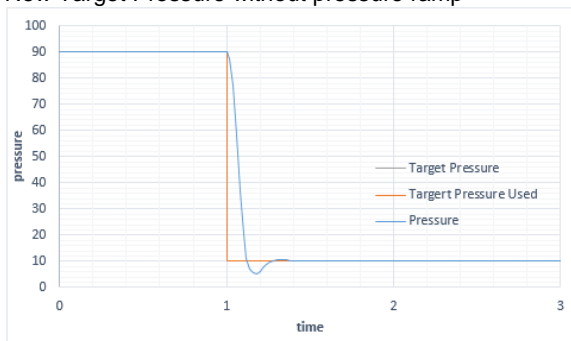

New Target Pressure with pressure ramp

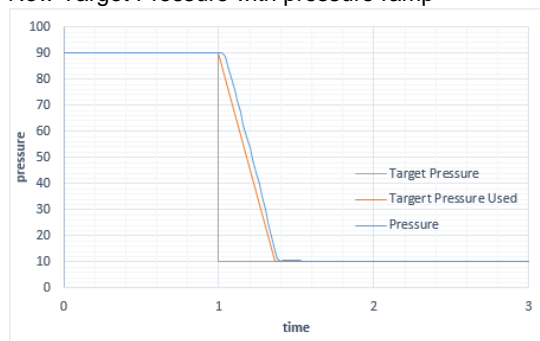

**Smoothing a staircase**

Pressure ramp with new target pressure to the valve every second is smoothed by a 1 sec internal ramp  
 Ramp Time = 1sec

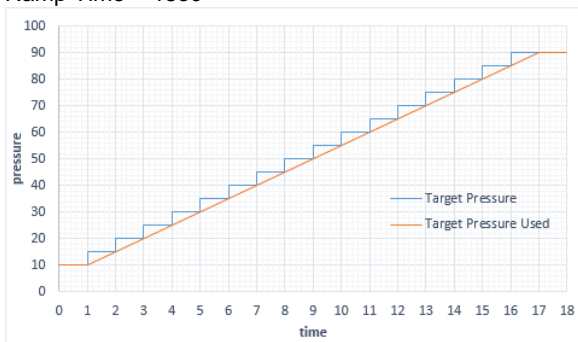

### 5.3.6 Profile Ramp

Profile Ramp is a **Target Pressure** ramp that depends on pressure ranges (segments). It is mainly used to create soft pumping or soft venting profiles.

To design a profile, the segments (pressure ranges) must be defined. A segment is defined by the pressure **Threshold** and the **Slope**. It is possible to define up to 10 segments.

Example: Ramp Profile with 3 segments

Segment Nr	Threshold mBar*	Resulting Segment mBar*	Slope mBar*/sec
1	1000	500 to 1000	50
2	500	200 to 500	100
3	200	0 to 200	200

Result is a Target Pressure Ramp (**Target Pressure Used**) with different slopes depending on pressure ranges:

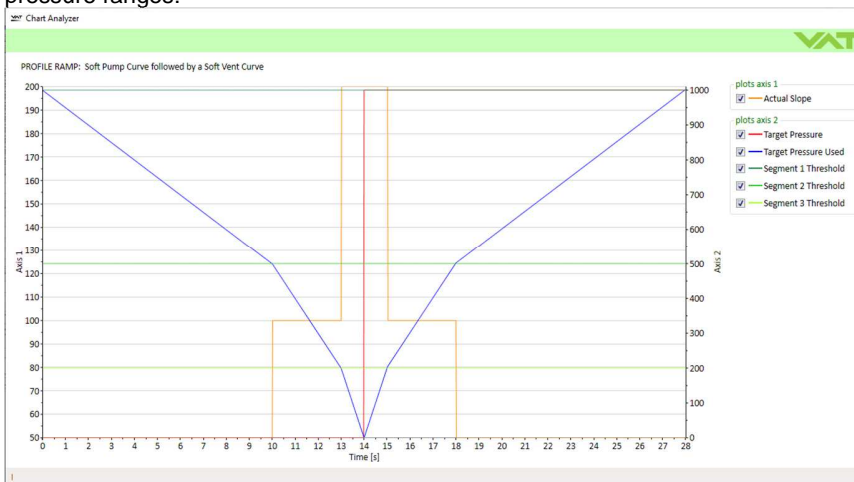

Parameters window showing configuration for Profile Ramp:

- Enable: True
- Threshold Mode: Target Pressure Used
- Ramp Type: Linear
- Actual Slope: 50 [mbar]
- Controller Selector Bitmap: 2
- Segment Selector Bitmap: 7
- Segment 1 Threshold: 1000 [mbar]
- Segment 1 Slope: 50 [mbar]
- Segment 2 Threshold: 500 [mbar]
- Segment 2 Slope: 100 [mbar]
- Segment 3 Threshold: 200 [mbar]
- Segment 3 Slope: 200 [mbar]



Parameters:

Location: CPA/Navigation/Parameters: Pressure Control.General Settings.Profile Ramp

Parameter	Description
<b>Enable</b>	Switches on/off the function
<b>Threshold Mode</b>	Defines which pressure the threshold refers to

**Actual Pressure**

Change happens if **Actual Pressure** reaches the **Threshold**

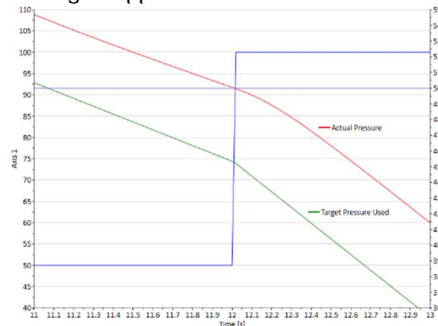

**Target Pressure Used**

Change happens if **Target Pressure Used** reaches the **Threshold**

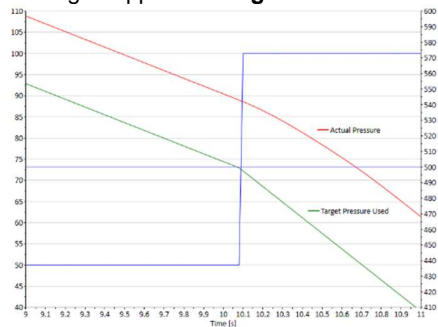

**Ramp Type** Defines the shape of the ramp

- Linear
- Logarithmic
- Exponential

**Actual Slope** Show the actual use slope during pressure control in mBar\*/sec.

**Controller Selector Bitmap** Determines which Controller uses the profile ramp. When a Controller is selected, the ramp is no longer used in the controller itself. Therefore the ramp is greyed out in the CPA.

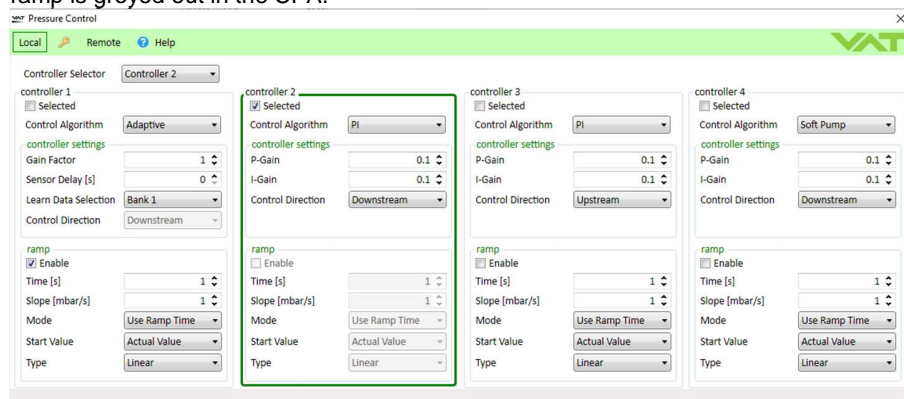

**Segment Selector Bitmap** Defines which segments is used for the Profile Ramp.

**Segment x Threshold** This is the upper limit of the segment. The lower limit is defined by the next lower **Threshold**, or the lower limit is 0 if there is no lower **Threshold**.  
If the value exceeds the top threshold, the slope value of the top segment is used (Segment 1 in below example)

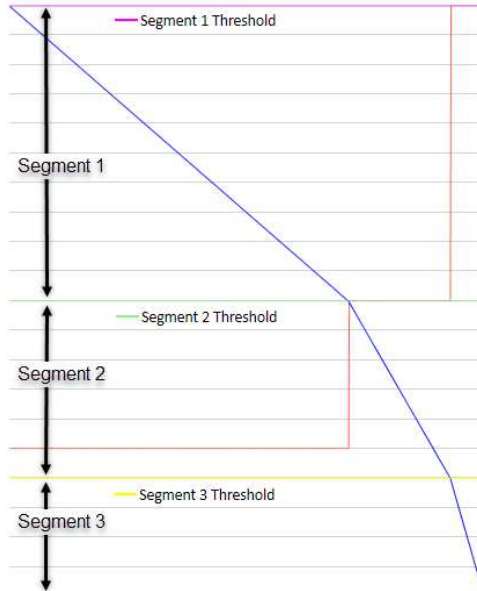

**Segment x Slope** Defines the slope (mBar\*/sec) in the segment

\* Unit adjustable



### 5.3.7 Automated Controller Selector

With the 4 Controllers it is possible to define different pressure control settings. The Automated Controller Selector can select one of the 4 Controllers depending on Target Pressure (**Mode: *Threshold***) or Up-Down Control (**Mode: *Pressure Direction***)

**Mode: *Threshold***

**Threshold Condition: *Lower or Equal***

**Controller Selector changes when the Target Pressure exceeds or falls below a *Threshold* value**

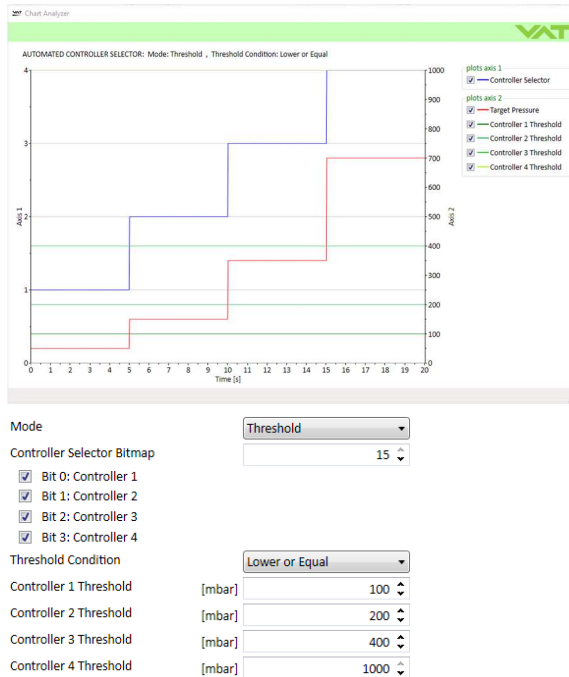

**Threshold Condition: *Equal***

**Controller Selector changes only when the Target Pressure is equal to a *Threshold* value**

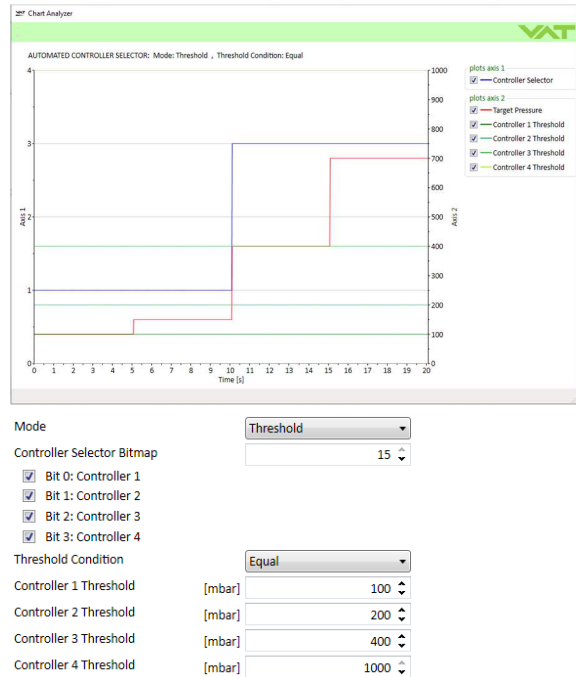

**Mode: *Pressure Direction***

**Controller Pressure Rising: *Controller 1***

**Controller Pressure Falling: *Controller 2***

**Controller Selector changes depending on whether Target Pressure is rising or falling**

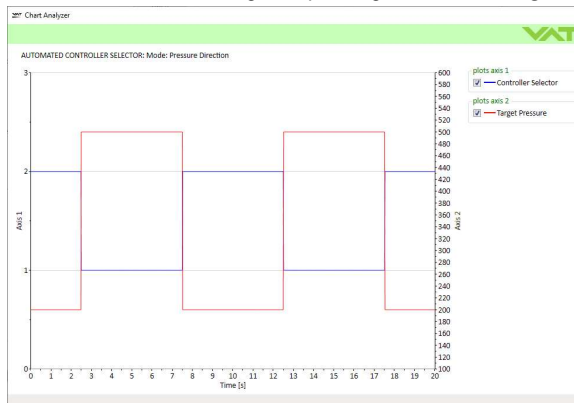

Mode: **Pressure Direction**

Controller Pressure Rising: **Controller 1**

Controller Pressure Falling: **Controller 2**

Parameter:

Location: CPA/Navigation/Parameters: Pressure Control.General Settings.Automated Controller Selector

Parameter	Description
<b>Enable</b>	Switches on/off the function
<b>Mode</b>	<a href="#">Threshold</a> <a href="#">Pressure Direction</a>
<b>Controller Selector Bitmap</b>	Used if <b>Mode</b> = <a href="#">Threshold</a> Defines which controllers are automatically selected
<b>Threshold Condition</b>	Used if <b>Mode</b> = <a href="#">Threshold</a> <a href="#">Lower or Equal</a> <a href="#">Equal</a> The Thresholds are related to <b>Target Pressure</b>
<b>Controller 1 Threshold</b>	Used if <b>Mode</b> = <a href="#">Threshold</a>
<b>Controller 2 Threshold</b>	The Thresholds are related to <b>Target Pressure</b>
<b>Controller 3 Threshold</b>	
<b>Controller 4 Threshold</b>	
<b>Controller Pressure Rising</b>	Used if <b>Mode</b> = <a href="#">Pressure Direction</a>
<b>Controller Pressure Falling</b>	Select one Controller for up control and one for down control <a href="#">Controller 1</a> <a href="#">Controller 2</a> <a href="#">Controller 3</a> <a href="#">Controller 4</a>

### 5.3.8 Control Position Restriction

Location: CPA/Navigation/Parameters: Pressure Control.General Settings.Control Position Restriction

Parameter	Description
<b>Enable</b>	False True
<b>Minimum Control Position</b>	Defines the lowest position during pressure control
<b>Maximum Control Position</b>	Defines the highest position during pressure control
<b>Restriction Active</b>	False True

### 5.3.9 Store Control Parameter Volatile

Used when the control parameters are changed frequently during the process and it is not useful to store the value in the non-volatile memory each time (the lifetime of the non-volatile value is 1 million memory cycles).

Only effective on the interface, the settings via CPA are always stored in non-volatile memory

Location: CPA/Navigation/Parameters: Pressure Control.General Settings

Parameter	Description
<b>Store Control Parameter Volatile</b>	False True

## 5.4 Position Control

### 5.4.1 Parameter

*Location: CPA/Navigation/Parameters: Position Control*

Parameter	Description
<b>Actual Position</b>	Position of the valve plate Range depends on Position Scaling setting (on Interface and CPA)
<b>Target Position</b>	Desired position of the valve plate Range depends on Position Scaling setting (on Interface and CPA)
<b>Position Control Speed</b>	Speed of the valve in Control Mode Position 0.001 .. 1.0 (Full speed)
<b>Ramp</b>	See below

### 5.4.2 Position Ramp



#### 5.4.2.1 Configuration

*Location: CPA/Navigation/Parameters: Position Control.Ramp*

Parameter	Description
<b>Enable</b>	Activate / Deactivate position ramp
<b>Mode</b>	0:Use <b>Ramp Time</b> 1:Use <b>Ramp Slope</b> <span style="float: right;">See description below</span>
<b>Time</b>	Target reach time in seconds (Used if <b>Mode</b> = 0)
<b>Slope</b>	Limit the rate of position change per second (Used if <b>Mode</b> = 1)
<b>Type</b>	0:Linear 1:Logarithmic 2:Exponential

5.4.2.2 Mode

**Time**

Unit: seconds

Time is constant, slope varies

Example: 2 sec

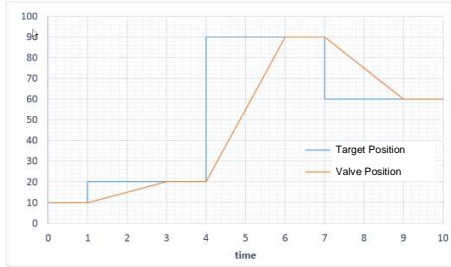

**Slope**

Unit: %\* / seconds

Slope is constant, time varies

Example: 10% / sec

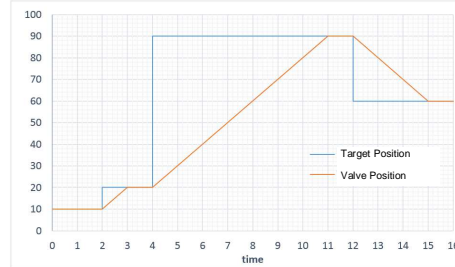

\* Unit adjustable

5.4.2.3 Type

**Linear**

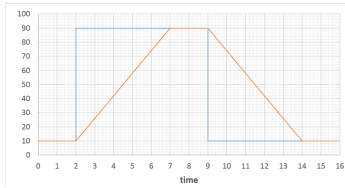

**Logarithmic**

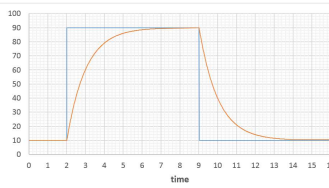

**Exponential**

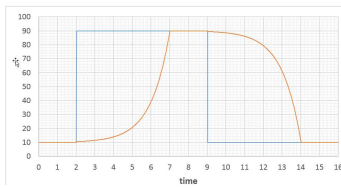

5.5 Operation under increased temperature

	<b>CAUTION</b>
	<p><b>Hot valve</b></p> <p>Heated valve may result in minor or moderate injury.</p> <p>Do not touch valve and heating device during operation. Once heating is switched off (valve and system) await until the valve is cooled down complete before doing any work.</p>



This valve may be operated in the temperature range mentioned product data sheet.

	<b>WARNING</b>
	<p><b>O-ring sticking</b></p> <p>Due to the sticking properties of elastomer O-rings at high temperature, operator/integrator must ensure the vacuum product settled at the same temperature prior to opening as it was when it was closed otherwise there is a risk of damage to the O-ring.</p>

## 6 Trouble shooting

### 6.1 Warnings



A warning does not lead to an interruption of valve operation.

*Location: CPA/Parameters: System.Services*

Parameter	Description		
<b>Warning Bitmap</b>	Bit	Hex	Description
	0	1	No learn data available for adaptive control
	1	2	Position indicator signal of the external isolation valve incorrect.
	2	4	No Sensor Active
	3	8	PFO Not Ready
	4	16	Cluster Slave Offline
	6	40	Fieldbus Data Not Valid
	8	256	Compressed Air Not Falling when valve close
	9	512	Compressed Air Too Low
	10	1024	Compressed Air Too High
	12	4096	Fan stall alarm

Failure	Check	Action
Display does not light up	- 24 V power supply	- Connect valve to power supply according to 'Power, ground and sensor connection' and make sure that power supply is working.
Remote operation does not work	- Local operation via service port active	- Switch to remote or locked operation Refer to 'Remote and local operation'
	- Safety mode active Check for S on display	- Check 'Drive Power Enable Switch' Refer to 'Power, ground and sensor connection'
	- Interlock mode active Check for I on display	- Check Digital Input Refer to 'Power connector IO' → 'Digital Input'
POSITION CONTROL does not work	- Safety mode active Check for S on display	- Check 'Drive Power Enable Switch' Refer to 'Power, ground and sensor connection'
	- Interlock mode active Check for I on display	- Check Digital Input Refer to 'Power connector IO' → 'Digital Input'
	- POSITION CONTROL selected, check for A on display?	- Select POSITION CONTROL mode. Refer to 'Control Mode' in 'EtherCAT' interface
Pressure reading is wrong	- Sensor connection	- Refer to 'Power, ground and sensor connection'
Pressure reading is negative	- ZERO done?	- Perform ZERO when base pressure is reached. Refer to 'Pressure Sensor' → 'Zero Adjust'
	- Does sensor power supply provide enough power for sensor(s)?	- Verify sensor supply voltage.
ZERO does not work	- ZERO disabled?	- Enable ZERO. Refer to 'Pressure Sensor' → 'Zero Adjust'
	- Sensor voltage shifting?	- Wait until sensor does not shift any more before Performing ZERO.
Pressure is not '0' after ZERO	- System pumped to base pressure?	- OPEN VALVE and bring chamber to base pressure before performing ZERO.
	- Sensor offset voltage exceeds ±1.4V	- Adjust the offset direct at the sensor - Check function of the sensor.
PRESSURE CONTROL does not work	- PRESSURE CONTROL selected, check for P on display?	- Select PRESSURE CONTROL mode. Refer to 'Control Mode' in 'EtherCAT' interface
	- LEARN done?	- Perform LEARN. Refer to 'Pressure control' → 'Adaptive algorithm' → 'Learn'
	- Sensor signal ok?	- Refer to 'Pressure Sensor'
	- Pressure control setup done	- Refer to 'Pressure control'
PRESSURE CONTROL not optimal	- LEARN successfully done?	- Perform LEARN. Check 'Status' and 'Warning Info' in 'Pressure control' → 'Adaptive algorithm' → 'Learn'
	- ZERO performed before LEARN?	- Perform ZERO then repeat LEARN. Refer to 'Pressure Sensor' → 'Zero Adjust'
	- Was gas flow stable during LEARN?	- Repeat LEARN with stable gas flow. Refer to 'Pressure control' → 'Adaptive algorithm' → 'Learn'
	- Tuning done?	- Tune valve for application. Refer to the tuning sections in 'Pressure Control'
	- Is sensor range suited for application?	- Use a sensor with suitable range (controlled pressure should be >3% and < 98% of sensor full scale).
	- Noise on sensor signal?	- Make sure a shielded sensor cable is used.



## 6.2 Errors

 If valve is in Control Mode Error, movement is no longer possible.

The following parameters provide information about the cause of the error:

*Location: CPA/Parameters: System.Services*

Parameter	Description
<b>Error Bitmap</b>	Information about the types of errors. Details below.
<b>Error Number</b>	Information about the error component. Details below. Also shown on the controller display when active.
<b>Error Code</b>	Information about the different error states. Details below. Also shown on the controller display when active.

 If you need any further information, please contact one of our service centers. You will find the addresses on our website: [www.vatvalve.com](http://www.vatvalve.com)

The following information is required for VAT to analyze the error case:

- Diagnostic File: CPA → Tools → Diagnostic File
- Load Error Data: CPA → Tools → Trace Log → Mode Load Error Data → Start

### 6.2.1 Error Recovery

To leave the error state, the **Error Recovery** or **Restart Controller** can be used:

*Location: CPA/Parameters: System.Services*

Parameter	Description
<b>Restart Controller</b>	Emulates a power cycle of the valve
<b>Error Recovery</b>	Attempts to reset the Control Mode Error without restarting the valves

 Create a diagnostic file before recovery or restart if the error is to be analyzed by VAT

### 6.2.2 Error Bitmap

Parameter	Description		
<b>Error Bitmap</b>	Bit	Hex	Description
	0	1	Homing Position Error
	1	2	Homing Not Running
	2	4	Homing Error State
	3	8	Operation Position Error
	4	10	Operation Not Running
	5	20	Operation Error State
	12	1000	Other Component
	30	40000000	General
	31	80000000	Internal

### 6.2.3 Error Number



Error numbers are three-digit decimal numbers (**xyz**) whereas:

x = component	y = mode	z = error type
<b>1</b> = All Motor Units <b>2</b> = Motor Unit 1 <b>3</b> = Motor Unit 2 <b>4</b> = Motor Unit 3 <b>8</b> = Other	<b>0</b> = Homing <b>2</b> = Operation Mode <b>8</b> = Other	<b>0</b> = Position Error <sup>1)</sup> <b>1</b> = Not running: No communication with component <b>x</b> <b>2</b> = Error State: component <b>x</b> is running but in Status Error <b>8</b> = Other

### 6.2.4 Error Code

<sup>1)</sup> Mechanical movement problem:

- Check for differential pressure
- Remove foreign object in movement area
- Eliminate tight movement
- Repair mechanical failure

Code	Description	Solution
1	No valve connected	Connect valve controller to the valve
2	Nonvolatile memory failure	Replace valve controller
3	Analog digital converter of sensor input failure	Replace valve controller
4	Initialization of motion controller failed	Wrong motion controller firmware version → Update motion controller firmware
5	Encoder index pulse not found	<ul style="list-style-type: none"> <li>• <sup>1)</sup></li> <li>• Encoder failure</li> <li>• O-ring sticking</li> </ul>
6	Initialization of interface module failed	<ul style="list-style-type: none"> <li>• Fieldbus: Valve firmware does not support interface type → Update valve firmware</li> <li>• Wrong interface firmware version → Update interface firmware</li> </ul>
7	Initialization of external drive EEPROM failed	Check cables
10	Closing position can't be reached	<sup>1)</sup>
11	Homing position can't be reached	<ul style="list-style-type: none"> <li>• <sup>1)</sup></li> <li>• Plate not mounted</li> </ul>
12	Motion controller: Internal voltage error	Check power supply
13	Motion controller: Internal error temperature	Check for a heat accumulation
14	Motion controller: Unexpected behavior	Contact vat support <ul style="list-style-type: none"> <li>• Axis inverted</li> <li>• Encoder not connected</li> <li>• Break not released</li> </ul>
15	Motion controller: Target position can't be reached	<ul style="list-style-type: none"> <li>• <sup>1)</sup></li> <li>• Current Settings</li> </ul>
16	Motion controller: Position minimal conductance cannot be reached	<ul style="list-style-type: none"> <li>• <sup>1)</sup></li> <li>• Check Plate and Seal ring</li> <li>• Check Parameter "Isolation Position Enter [r]"</li> </ul>
17	Motion controller: Position to push back the Differential Plate cannot be reached	<ul style="list-style-type: none"> <li>• <sup>1)</sup></li> <li>• Check Different Plate</li> <li>• Check Parameter "Differential Plate Push Back Position [r]"</li> </ul>
18	Motion controller: Minimal isolation position cannot be reached	<ul style="list-style-type: none"> <li>• <sup>1)</sup></li> <li>• Check Plate and Seal ring</li> <li>• Check Parameter "Isolation Position [r]"</li> </ul>
20	Break slippery detected	Replace actuator

Code	Description	Solution
30	SFV: Motion controller failure in master-slave communication	Contact vat support
40	Compressed air error	Check compressed air
42	Power supply, low voltage detected	Check if power supply is ok and is able to deliver needed power
96	SFV: Position deviation axis1 to axis2 at homing procedure	<ul style="list-style-type: none"> <li>• <sup>1)</sup></li> <li>• O-ring sticking</li> </ul>
97	SFV: Position deviation axis1 to axis2 at operating	<sup>1)</sup>
98	Position error during closing procedure	<sup>1)</sup>
99	Position error at operating	<sup>1)</sup>
200	Valve configuration error, not possible to operate the valve with these configuration	Contact VAT support
701	Wrong ident code axis 1	Check wiring
702	Wrong ident code axis 2	
703	Wrong ident code axis 2 AND axis 1	
704	Wrong ident code axis 3	
705	Wrong ident code axis 3 AND axis 1	
706	Wrong ident code axis 3 AND axis 2	
707	Wrong ident code axis 3 AND axis 2 AND axis 1	
707	Do not operating mode active	

### 6.3 Troubleshooting List

Failure	Check	Action
Display does not light up	- 24 V power supply	- Connect valve to power supply according to 'Power, ground and sensor connection' and make sure that power supply is working.
Remote operation does not work	- Local operation via service port active	- Switch to remote or locked operation Refer to 'Remote and local operation'
	- Safety mode active Check for S on display	- Check 'Drive Power Enable Switch' Refer to 'Power, ground and sensor connection'
	- Interlock mode active Check for I on display	- Check Digital Input Refer to 'Power connector IO' → 'Digital Input'
POSITION CONTROL does not work	- Safety mode active Check for S on display	- Check 'Drive Power Enable Switch' Refer to 'Power, ground and sensor connection'
	- Interlock mode active Check for I on display	- Check Digital Input Refer to 'Power connector IO' → 'Digital Input'
	- POSITION CONTROL selected, check for A on display?	- Select POSITION CONTROL mode. Refer to 'Control Mode' in 'EtherCAT' interface
Pressure reading is wrong	- Sensor connection	- Refer to 'Power, ground and sensor connection'
Pressure reading is negative	- ZERO done?	- Perform ZERO when base pressure is reached. Refer to 'Pressure Sensor' → 'Zero Adjust'
	- Does sensor power supply provide enough power for sensor(s)?	- Verify sensor supply voltage.
	- ZERO does not work	- Enable ZERO. Refer to 'Pressure Sensor' → 'Zero Adjust'
ZERO does not work	- ZERO disabled?	- Enable ZERO. Refer to 'Pressure Sensor' → 'Zero Adjust'
	- Sensor voltage shifting?	- Wait until sensor does not shift any more before Performing ZERO.
Pressure is not '0' after ZERO	- System pumped to base pressure?	- OPEN VALVE and bring chamber to base pressure before performing ZERO.
	- Sensor offset voltage exceeds ±1.4V	- Adjust the offset direct at the sensor - Check function of the sensor.
PRESSURE CONTROL does not work	- PRESSURE CONTROL selected, check for P on display?	- Select PRESSURE CONTROL mode. Refer to 'Control Mode' in 'EtherCAT' interface
	- LEARN done?	- Perform LEARN. Refer to 'Pressure control' → 'Adaptive algorithm' → 'Learn'
	- Sensor signal ok?	- Refer to 'Pressure Sensor'
	- Pressure control setup done	- Refer to 'Pressure control'
PRESSURE CONTROL not optimal	- LEARN successfully done?	- Perform LEARN. Check 'Status' and 'Warning Info' in 'Pressure control' → 'Adaptive algorithm' → 'Learn'
	- ZERO performed before LEARN?	- Perform ZERO then repeat LEARN. Refer to 'Pressure Sensor' → 'Zero Adjust'
	- Was gas flow stable during LEARN?	- Repeat LEARN with stable gas flow. Refer to 'Pressure control' → 'Adaptive algorithm' → 'Learn'
	- Tuning done?	- Tune valve for application. Refer to the tuning sections in 'Pressure Control'
	- Is sensor range suited for application?	- Use a sensor with suitable range (controlled pressure should be >3% and < 98% of sensor full scale).
	- Noise on sensor signal?	- Make sure a shielded sensor cable is used.

## 7 Maintenance

	<p style="text-align: center;"><b>⚠ WARNING</b></p> <p><b>Unqualified personnel</b> Inappropriate handling may cause serious injury or property damage. Only qualified personnel are allowed to carry out the described work.</p>
	<p style="text-align: center;"><b>⚠ WARNING</b></p> <p><b>Valve opening</b> Risk of serious injury. Human body parts must be kept out of the valve opening and away from moving parts. Disconnect power on controller before doing any work.</p>
	<p style="text-align: center;"><b>⚠ CAUTION</b></p> <p><b>Hot valve</b> Heated valve may result in minor or moderate injury. Do not touch valve and heating device during operation. Once heating is switched off (valve and system) await until the valve is cooled down complete before doing any work.</p>
	<p style="text-align: center;"><b>NOTICE</b></p> <p><b>Contamination</b> Gate and other parts of the valve must be protected from contamination. Always wear clean room gloves when handling the valve.</p>

### 7.1 Maintenance intervals

Under clean operating conditions, the valve does not require any maintenance during the specified cycle life. Contamination from the process may influence the function and requires more frequent maintenance.

Before carrying out any maintenance, please contact VAT. It has to be individually decided whether the maintenance can be performed by the customer or has to be carried out by VAT. Please write down the fabrication number of the valve before contact VAT. Refer to chapter «Identification of product» for fabrication number.

## 7.2 Maintenance procedures

Two maintenance procedures are defined for this valve. This are:

- Replacement of shaft feedthrough seals and valve cleaning. Refer to chapter: «Replacement of rotary feedthrough».
- Replacement of Option board. Refer to chapter: «Replacement of Option board»



Required frequency of cleaning and replacement of seals is depending on process conditions.

VAT can give the following recommendations for preventive maintenance:

Replacement of	unheated <sup>1)</sup>	heated $\leq 80\text{ °C}$ <sup>1)</sup>	heated $> 80\text{ °C}$ <sup>1)</sup>
<b>Rotary feedthrough seals</b>	2'000'000 cycles	6 months but max. 2'000'000 cycles	3 months but max. 2'000'000 cycles



<sup>1)</sup> Those figures are reference values for clean conditions under various temperatures. These values do not include any impact of the process. Therefore preventive maintenance schedule has finally to be checked for the actual process conditions.



Below pictures are sample pictures. Although there may be different variants of the valve, the assembly procedure stays the same.



ISO-KF with heating









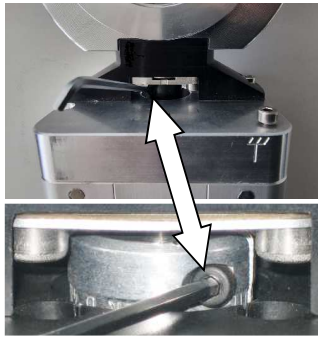

ISO-F

## 7.2.1 Replacement of shaft feedthrough seals and valve cleaning

### 7.2.1.1 Required tools

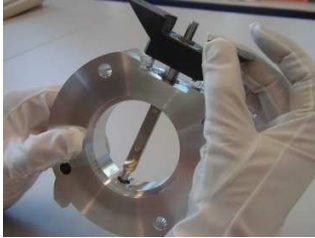

- Allen Wrench 2 mm / 2.5mm
- Clean room wipes, isopropyl alcohol
- Allen Wrench 3 mm
- Vacuum grease
- Feeler gauge

Description		Required tool
<ol style="list-style-type: none"> <li>1. Vent vacuum system on both sides of the valve.</li> <li>2. Make sure the valve is in closed position</li> <li>3. Disconnect electrical POWER connector at valve and remove valve from vacuum system.</li> </ol> <p> Take care not to damage sealing surface! Do not move the plate by hands when control and actuating unit is installed.</p>		
4. Unfasten clamp coupling		Allen Wrench: steel coupling 2.5 mm
5. Unfasten the 2 (DN-25-50) or 4 (DN 63-320) connection bolts and separate both parts.		Allen Wrench 3 mm
<p> Valve size DN 160 (6") and bigger require a shortened wrench. For ordering number refer to «Spare parts and accessories».</p> <p>12 mm </p>		

Description		Required tool
<p>6. Unfasten screws and remove plate from shaft.</p>		<p>Allen Wrench 3 mm</p>
<p>7. Unfasten alternately the 2 mounting screws little by little.</p> <p> If only one screw is fasten / unfasten, the mechanical unit will be damaged. Max. difference should be less than 1 turn or 0.5 turn of the screws.</p>		<p>Allen Wrench 3 mm</p>
<p>8. Remove mechanical unit and clean shaft.</p>		
<p>9. Remove O-rings. 10. Clean shaft feedthrough and valve body.</p>		<p>Clean room wipes a little soaked with isopropyl alcohol</p>



Description		Required tool																																			
11. Lubricate seal contact surface of valve body with a slight film of vacuum grease (0.025 ml). 12. Lubricate each O-ring with a slight film of vacuum grease (0.0125 ml).																																					
13. Lubricate seal contact surface of shaft with a slight film of vacuum grease (0.0125 ml). 14. Slide both O-rings onto shaft till the end. 15. Deposit 0.0375 ml vacuum grease between the O-rings 16. Clean shaft from vacuum grease.		Vacuum grease  Clean room wipes																																			
17. Assemble mechanical unit in reverse order as disassembled (steps 6 to 5).  18. Align pedestal parallel to valve body and tighten the 2 mounting screws with 2.5 Nm   Make sure the pedestal is aligned to be parallel with the valve body		Allen Wrench 3mm																																			
19. Center plate.	<table border="1"> <thead> <tr> <th rowspan="2">Size</th> <th colspan="2">Feeler gauge mm</th> </tr> <tr> <th>Unheated AL/ steel body</th> <th>Heated-AL body</th> </tr> </thead> <tbody> <tr><td>25</td><td>0.04</td><td>0.06</td></tr> <tr><td>40</td><td>0.04</td><td>0.06</td></tr> <tr><td>50</td><td>0.04</td><td>0.06</td></tr> <tr><td>63</td><td>0.04</td><td>0.06</td></tr> <tr><td>80</td><td>0.06</td><td>0.08</td></tr> <tr><td>100</td><td>0.06</td><td>0.08</td></tr> <tr><td>160</td><td>0.08</td><td>0.10</td></tr> <tr><td>200</td><td>0.08</td><td>0.10</td></tr> <tr><td>250</td><td>0.10</td><td>0.12</td></tr> <tr><td>320</td><td>0.12</td><td>0.14</td></tr> </tbody> </table>	Size	Feeler gauge mm		Unheated AL/ steel body	Heated-AL body	25	0.04	0.06	40	0.04	0.06	50	0.04	0.06	63	0.04	0.06	80	0.06	0.08	100	0.06	0.08	160	0.08	0.10	200	0.08	0.10	250	0.10	0.12	320	0.12	0.14	<p>Actuator side</p>
Size	Feeler gauge mm																																				
	Unheated AL/ steel body	Heated-AL body																																			
25	0.04	0.06																																			
40	0.04	0.06																																			
50	0.04	0.06																																			
63	0.04	0.06																																			
80	0.06	0.08																																			
100	0.06	0.08																																			
160	0.08	0.10																																			
200	0.08	0.10																																			
250	0.10	0.12																																			
320	0.12	0.14																																			
20. Tighten plate screws with	<table border="1"> <thead> <tr> <th>Size</th> <th>Nm</th> </tr> </thead> <tbody> <tr><td>25</td><td>1.1</td></tr> <tr><td>40</td><td>2.5</td></tr> <tr><td>&gt;=50</td><td>2.5</td></tr> </tbody> </table>	Size	Nm	25	1.1	40	2.5	>=50	2.5	Allen Wrench 3 mm  Adequate feeler gauge																											
Size	Nm																																				
25	1.1																																				
40	2.5																																				
>=50	2.5																																				

Description		Required tool
21. Assemble control and actuating unit to valve unit. Tighten mounting screws adequately.		Allen Wrench 3mm
22. Tighten clamp coupling: <ul style="list-style-type: none"> <li>• with steel coupling 2.2 Nm</li> </ul>		Allen Wrench: steel coupling 2.5 mm
23. Reinstall valve into vacuum system according to chapter «Installation».		

## 7.2.2 Replacement of Option board

	<b>NOTICE</b>
	<p><b>Electrostatic discharge</b></p> <p>Electronic components could be damage.</p> <p>All work on the control and actuating unit has to be done under ESD protected environment to prevent electronic components from damage.</p>

	<b>NOTICE</b>
	<p><b>Burned connector pins (spark)</b></p> <p>Connector pins or electronic parts could damage, if plugged and unplugged under power.</p> <p>Do not plug or unplug connectors under power.</p>

The option board may or may not be equipped in your valve depending on the order. Refer to page 1 of this manual to check valve version. This board includes the optional modules for the valve which are:

- $\pm 15$  VDC sensor power supply (SPS)
- Power failure option (PFO)

It is available in 3 versions. These are:

- SPS module only
- PFO module only
- SPS and PFO module

The modules may be retrofitted or replaced easily. The battery lifetime of the PFO module depends on the ambient temperature (see below). To assure PFO function the option board must be replaced after battery life has expired. For ordering number of the modules refer to chapter «Spare parts».

**7.2.2.1 Durability of power fail battery**

The curves in the graph show the estimated life of Ultra Cap PFO in the worst condition (max. sensor load = 1 A, valve heating temperature = 150 °C).

If the SPS is not fully loaded (< 1 A) or heating temperature of valve body is lower than 150 °C, the corresponding life time curve will be somewhere in between the upper and the lower curve.

Therefore please determine the equivalent maintenance period for replacing the Ultra Cap battery (Option board).

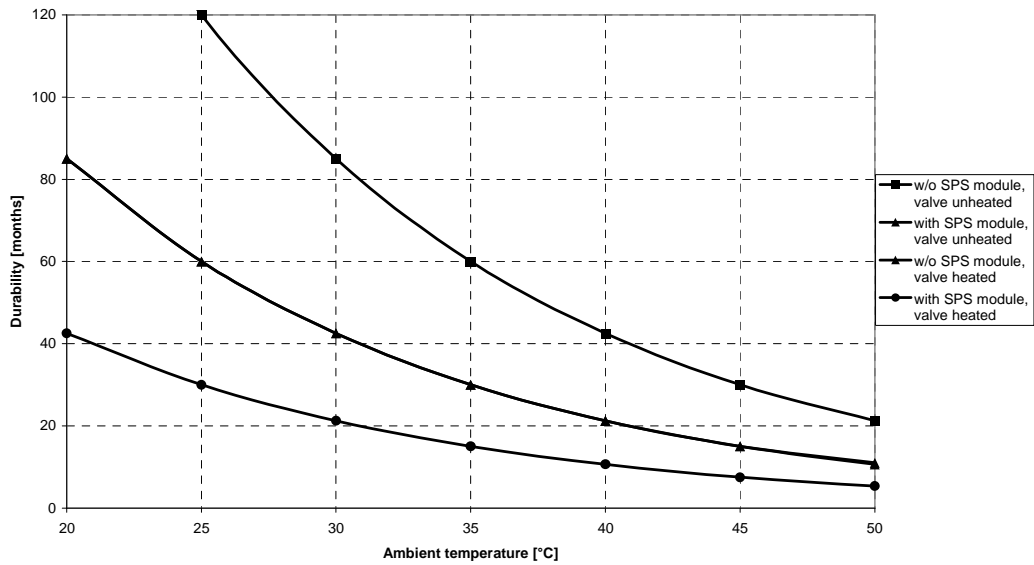

This graph shows estimated life of Ultra Cap PFO for reference and not as guaranteed value.

### 7.2.2.2 Retrofit / replacement procedure

View on control and actuating unit:

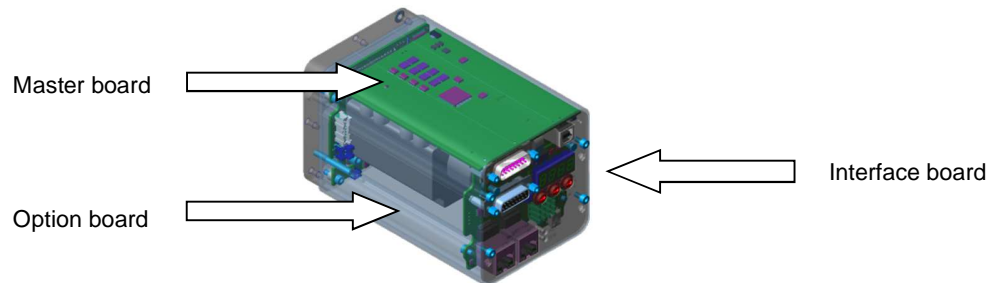

All boards have a fixed position into control and actuating unit. It is not possible to fit a board in other position as shown in picture above! Do not try out other positions, which maybe destroy the socket of boards!





**7.2.2.3 Required tools**

- Allen Wrench 2 mm / 2.5mm
- Allen Wrench 3 mm

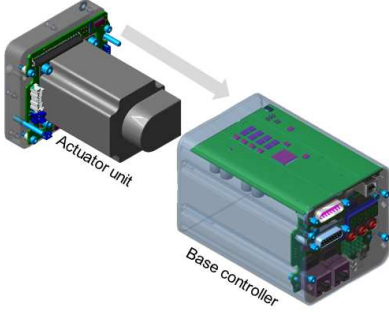

If you need any further information, please contact one of our service centers. You can find the addresses on our website: [www.vatvalve.com](http://www.vatvalve.com).

Description		Required tool
<p> Make sure that the valve is in closed position</p> <p>1. Vent vacuum system, disconnect electrical connections and remove valve from vacuum system. If you only replace control and actuating unit, the valve can remain in the system.</p> <p> Take care not to damage sealing surface!</p> <p><b>Attention!</b> Do not move the plate by hands when control an actuating unit is installed.</p>		Depending on flange screws
<p>2. Unfasten clamp coupling</p>		Allen Wrench: steel coupling 2.5 mm
<p>3. Unfasten the 4 connection bolts and separate both parts.</p> <p> Valve size DN 160 (6") and bigger require a shortened wrench. For ordering number refer to «Spare parts and accessories».</p> <p>12 mm </p>		Allen Wrench 3 mm

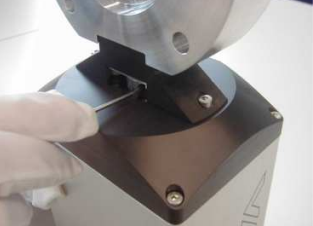
Description	Required tool	
<p>4. Replacement of the option board / whole controller</p> <p>Unfasten the two bolts from bottom side and and dismount the controller from the actuator unit.</p> <p>The SPS/PFO option board has to be mounted/ dismounted from bottom side of the controller.</p> <p>The Controller and Interface board are fix connected and shall not be dismantled.</p> <p> you have to work on an ESD-protected working space</p> <p> If you need any further information, please contact one of our service centers. You can find the addresses on our website: <a href="http://www.vatvalve.com">www.vatvalve.com</a></p>		
<p>5. Assemble control and actuating unit to valve unit. Tighten mounting screws adequately.</p>		<p>Allen Wrench: 3mm</p>
<p>6. Tighten clamp coupling:</p> <ul style="list-style-type: none"> <li>• with elastic coupling 1.1 Nm</li> <li>• with steel coupling 2.2 Nm</li> </ul>		<p>Allen Wrench: steel coupling 2.5 mm</p>
<p>7. Reinstall valve into vacuum system according to chapter «Installation».</p>		

## 8 Repairs

Repairs may only be carried out by the VAT service staff. In exceptional cases, the customer is allowed to carry out the repairs, but only with the prior consent of VAT.

Please contact one of our service centers. You will find the addresses on our website [www.vatvalve.com](http://www.vatvalve.com).

### 8.1 FPR Service

The VAT customer service can refurbish the product or individual components for you. Wear-sensitive parts are replaced, and the guarantee on the replaced parts is extended.

- a) Select the desired Fixed Price Refurbishment service from our comprehensive service program for the refurbishment.
- b) Contact your assigned sales person or the nearest VAT service center to learn about the options for the product in question. [www.vatvalve.com](http://www.vatvalve.com).



## 9 Dismounting and Storage

	<b>⚠ WARNING</b>
	<b>Unqualified personnel</b> Inappropriate handling may cause serious injury or property damage. Only qualified personnel are allowed to carry out the described work.

### 9.1 Dismounting

	<b>NOTICE</b>
	<b>Contamination</b> Gate and other parts of the valve must be protected from contamination. Always wear clean room gloves when handling the valve.

	<b>NOTICE</b>
	<b>Valve in open position</b> Valve body may become damaged if valve gate is in open position. Move valve gate to the closed position before dismantling the valve.

4. Close the valve
5. For dismantling the valve please follow the instructions of chapter: «Installation», however in reverse order.



## 9.2 Storage



<b>NOTICE</b>	
	<p><b>Wrong storage</b></p> <p>Inappropriate temperatures and humidity may cause damage to the product.</p> <p>Valve must be stored at:</p> <ul style="list-style-type: none"><li>– relative humidity between 10% and 70%</li><li>– temperature between +10 °C and +50 °C</li><li>– non-condensing environment</li></ul>

<b>NOTICE</b>	
	<p><b>Inappropriate packaging</b></p> <p>Product may get damaged if inappropriate packaging material is used.</p> <p>Always use the original packaging material and handle product with care.</p>

1. Clean / decontaminate valve.
2. Cover all valve openings with a protective foil.
3. Pack valve appropriately, by using the original packaging material.

## 10 Packaging and Transport

	 <b>WARNING</b>
	<p><b>Unqualified personnel</b></p> <p>Inappropriate handling may cause serious injury or property damage. Only qualified personnel are allowed to carry out the described work.</p>

	 <b>WARNING</b>
	<p><b>Harmful substances</b></p> <p>Risk of injury in case of contact with harmful substances. Remove harmful substances (e. g. toxic, caustic or microbiological ones) from valve before you return the valve to VAT.</p>

	<b>NOTICE</b>
	<p><b>Inappropriate packaging</b></p> <p>Product may get damaged if inappropriate packaging material is used. Always use the original packaging material and handle product with care.</p>



- When returning products to VAT, please fill out the VAT form «Declaration of Chemical Contamination of Vacuum Valves and Components» and send it to VAT in advance. The form can be downloaded from our website [www.vatvalve.com](http://www.vatvalve.com) (Section: Services – Aftersales).
- If products are radioactively contaminated, the VAT form «Contamination and Radiation Report» must be filled out. Please contact VAT in advance.
- If products are sent to VAT in contaminated condition, VAT will carry out the decontaminating procedure at the customer's expense.

## 10.1 Packaging

<b>NOTICE</b>	
	<p><b>Valve in open position</b> Valve mechanism may get damaged if valve is in open position. Make sure that the valve is closed.</p>

1. Cover all valve openings with a protective foil.
2. Pack valve appropriately, by using the original packaging material.



VAT disclaims any liability for damages resulting from inappropriate packaging.

## 10.2 Transport

<b>NOTICE</b>	
	<p><b>Inappropriate packaging</b> Product may get damaged if inappropriate packaging material is used. Always use the original packaging material and handle product with care.</p>





VAT disclaims any liability for damages resulting from inappropriate packaging.

## 11 Disposal

Observe the local regulations for disposal

	<b>⚠ WARNING</b>
	<p><b>Harmful substances</b> Environmental pollution. Discard products and parts according to the local regulations.</p>

	<b>⚠ WARNING</b>
	<p><b>Unqualified personnel</b> Inappropriate handling may cause serious injury or property damage. Only qualified personnel are allowed to carry out the disposal.</p>

	<b>⚠ CAUTION</b>
	<p><b>Risk of damage</b> Indicates a hazardous situation which, if not avoided, may result in minor or moderate injury. A large number of diverse materials are used in the product. Some of them could cause human and machine damage in the case of improper handling.</p> <ul style="list-style-type: none"> <li>• Observe local regulations in regard to waste disposal without fail.</li> <li>• Commission an authorized waste disposal company for the professional disposal of your waste.</li> </ul>

	<b>NOTICE</b>
	<p><b>Improper disposal</b> Some built-in materials can cause damage, if improperly handled. - When disposing, take into account all the different materials used</p>



- Hire an authorised waste disposal company to dispose of the waste in a professional manner.

The following list should help you to dismantle your product without making serious errors and to properly separate out the product scrap.

Material groups	Hazard level
non-ferrous metals	high
stainless steel	low
aluminum	low
plastics	medium
lubricants	high
electronic scrap	high
batteries	very high
cables and wires	medium
motors	medium
seals and rubber parts	high

## 12 Spare parts



### NOTICE

#### Non-original spare parts

Non-original spare parts may cause damage to the product.  
Use original spare parts from VAT only.



- Please specify the fabrication number of the product when you place an order for spare parts; see chapter: «Identification of product». This is to ensure that the appropriate spare parts are supplied.
- VAT makes a difference between spare parts that may be replaced by the customer and those that need to be replaced by the VAT service staff.
- The following table(s) contain spare parts that may be replaced by the customer. If you need any other spare parts, please contact one of our service centers. You will find the addresses on our website [www.vatvalve.com](http://www.vatvalve.com).



For versions such as:

- other valve sizes
- heated valves
- valves made of hard anodized aluminum
- valves made of nickel coated aluminum
- valves made of stainless steel
- valves with JIS, ASA or CF-F flanges

spare parts ordering numbers are available on request.

## 12.1 ISO-KF for DN 25 – 50 mm

### 12.1.1 Drawing ISO-KF

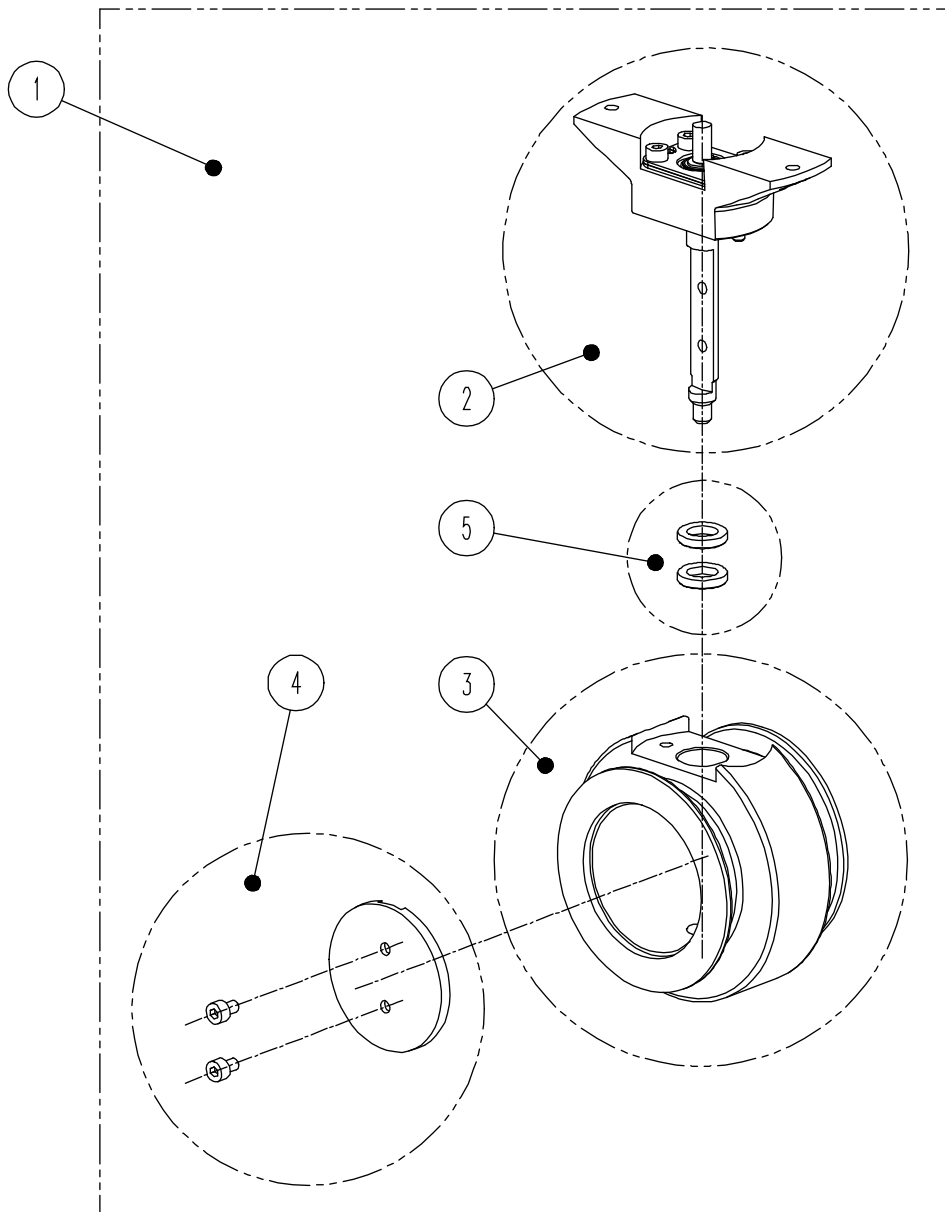

- 1 Body with mechanism
- 2 Shaft kit
- 3 Valve body
- 4 Plate kit
- 5 Shaft feedthrough seals



All "Items in below table" refer to this chapter «Drawing ISO-KF»

**12.1.2 ISO-KF valve unit - aluminum blank, without heating**

Item	Description			
	Valve size Product ordering number	DN 25 / 1" 61328 - KA . . ISO-KF	DN 40 / 1½" 61332 - KA . . ISO-KF	DN 50 / 2" 61334 - KA . . ISO-KF
1	Spare parts kit valve unit	488956	485726	486738
2	Spare parts kit mechanical unit	488946	471287	471292
3	Spare parts kit valve body	240574	232271	232272
4	Spare parts kit plate	253255	232276	232277
	Plate screws	361960 (2 pcs required)	353386 (2 pcs required)	353386 (2 pcs required)

**12.1.3 ISO-KF valve unit – stainless steel, without heating**

Item	Description			
	Valve size Product ordering number	DN 25 / 1" 61328 - KE . . ISO-KF	DN 40 / 1½" 61332 - KE . . ISO-KF	DN 50 / 2" 61334 - KE . . ISO-KF
1	Spare parts kit valve unit	489057	486772	485723
2	Spare parts kit mechanical unit	488946	471287	471292
3	Spare parts kit valve body	342558	243089	237850
4	Spare parts kit plate	342563	243090	239549
	Plate screws	361960 (2 pcs required)	353386 (2 pcs required)	353386 (2 pcs required)

**12.1.4 Seals and grease**

Item	Description		
	Valve size Product ordering number	All sizes 613 . . - . . . .	
5	Vacuum seal kit	VITON®	237235 (2x N-5100-204)
		Others	on request
	Vacuum grease syringe		206792 (2ml), 206793 (5ml)



## 12.2 ISO-F for DN 63 – 320 mm

### 12.2.1 Drawing ISO-F

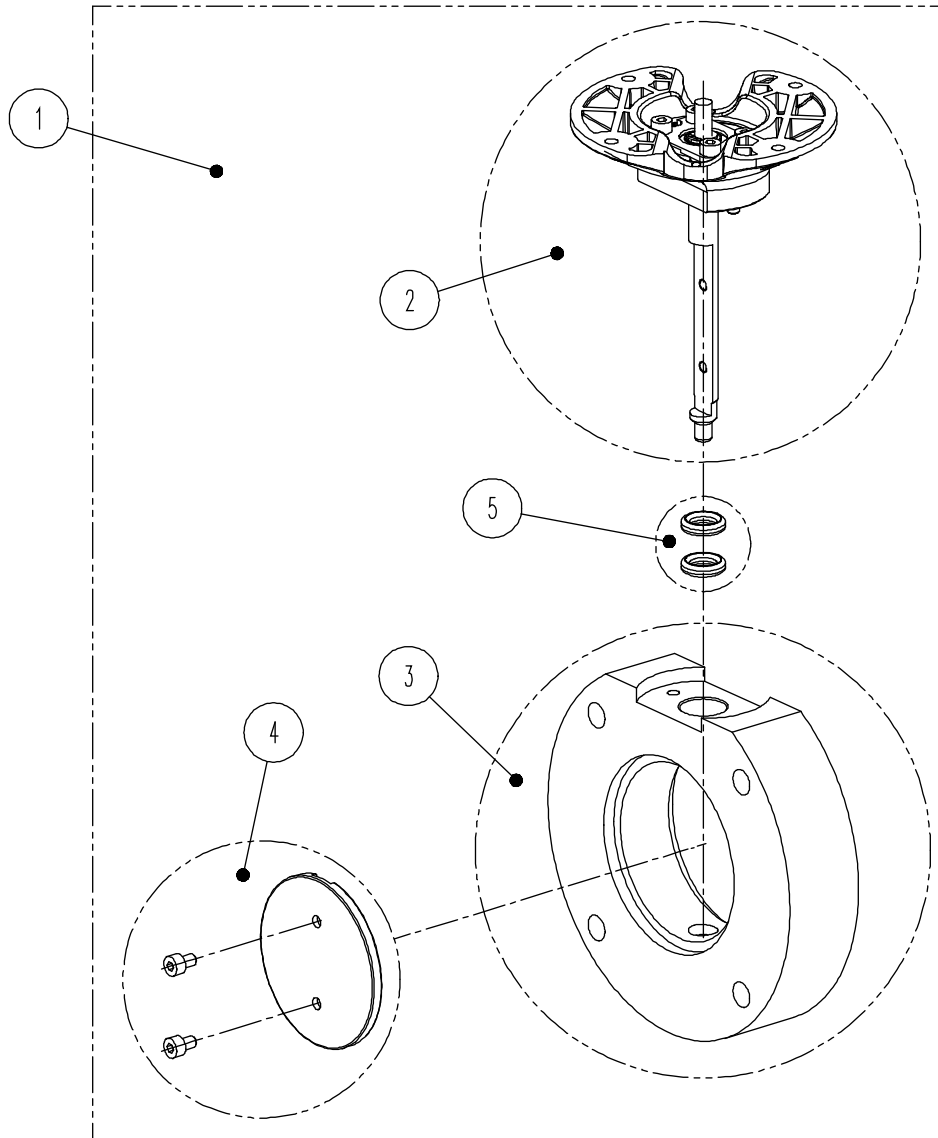

- 1 Body with mechanism
- 2 Shaft kit
- 3 Valve body
- 4 Plate kit
- 5 Shaft feedthrough seals



All "Items in below table" refer to this chapter «Drawing ISO-F»

**12.2.2 ISO-F valve unit - aluminum blank, without heating**

Item	Description							
	Valve size Product ordering number	DN 63 / 2½"	DN 80 / 3"	DN 100 / 4"	DN 160 / 6"	DN 200 / 8"	DN 250 / 10"	DN 320 / 12"
		61336-PA ..	61338-PA ..	61340-PA ..	61344-PA ..	61346-PA ..	61348-PA ..	61350-PA ..
1	Spare parts kit valve unit	490143	489471	490093	489026	491729	489827	249284
2	Spare parts kit mechanical unit	490144	489464	490094	489022	491728	489910	807298
3	Spare parts kit valve body	232273	232274	232275	243026	237716	241204	327111
4	Spare parts kit plate	232278	232279	232280	243028	237725	252046	327109
	Plate screws	353386 (2 pcs required)	353386 (3 pcs required)	353386 (3 pcs required)	353386 (3 pcs required)	353386 (3 pcs required)	353386 (3 pcs required)	353386 (3 pcs required)

**12.2.3 ISO-F valve unit – stainless steel, without heating**

Item	Description							
	Valve size Product ordering number	DN 63 / 2½"	DN 80 / 3"	DN 100 / 4"	DN 160 / 6"	DN 200 / 8"	DN 250 / 10"	DN 320 / 12"
		61336-PA ..	61338-PA ..	61340-PA ..	61344-PA ..	61346-PA ..	61348-PA ..	61350-PA ..
1	Spare parts kit valve unit	491837	491711	491749	491978	497131	502651	-
2	Spare parts kit mechanical unit	490144	489464	490094	489022	491728	489910	-
3	Spare parts kit valve body	252748	248433	252764	243026	252778	393073	-
4	Spare parts kit plate	252738	248463	252763	243028	244362	414211	-
	Plate screws	353386 (2 pcs required)	353386 (3 pcs required)	353386 (3 pcs required)	353386 (3 pcs required)	353386 (3 pcs required)	353386 (3 pcs required)	353386 (3 pcs required)

**12.2.4 Seals and grease**

Item	Description		
	Valve size Product ordering number	All sizes 613 ... - . . . .	
5	Vacuum seal kit	VITON ®	237235 (2x N-5100-204)
		Others	on request
	Vacuum grease syringe		206792 (2ml), 206793 (5ml)

Series  
613 Fehler!  
Verweisquelle  
konnte nicht  
gefunden  
werden.

FEHLER! VERWEISQUELLE KONNTE NICHT GEFUNDEN WERDEN.



## 12.3 Control unit and Accessories

### 12.3.1 Control and actuating unit

Description	Part number
Control and actuating unit	Too many to list. Please contact VAT.
Option board with SPS module (±15 VDC Sensor Power Supply)	858530
Option board with PFO module (Power Failure Option)	858529
Option board with SPS and PFO module	840512

### 12.3.2 Accessories

Description	Part number
24 VDC power supply unit (input: 100 – 240 VAC)	891528 (D-Sub15 connector)
Adapter cable for power supply with D-Sub9 connector	(735567) (D-Sub15 to D-Sub9)
Plug D-sub 15 pin female with 4- 40UNC screws for the power input and Logic interface (plug only)	81177-R1
Service cable (PC to valve Service connector)	809474 (USB A–B male-male)
Special Allen wrench (SW3) for disassembly and assembly	244873
O-ring removal tool	234859

### 12.3.3 Centering ring with VITON® O-ring

Description		DN 25 / 1	DN 40 / 1½"	DN 50 / 2"
Valve size Product ordering number		61328 - . . . .	61332 - . . . .	61334 - . . . .
Centering ring with VITON® O-ring (for ISO-KF and ISO- F installation only)	Aluminum	31028-KAZV-0001	31032-KAZV--0001	32034-KAZV-0001
	Stainless steel	31028-KEZV-0001	31032-KEZV-0001	32034-KEZV-0001

This page left blank intentionally.

**13**