



RS232 / RS485



Ether CAT



Device Net

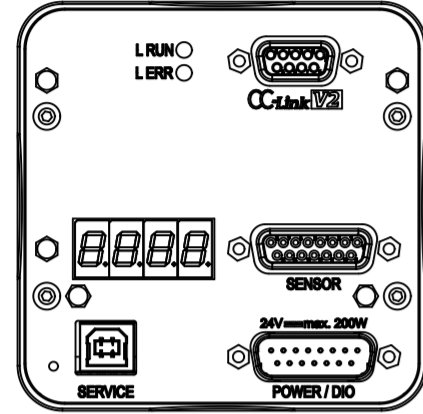

CC-Link

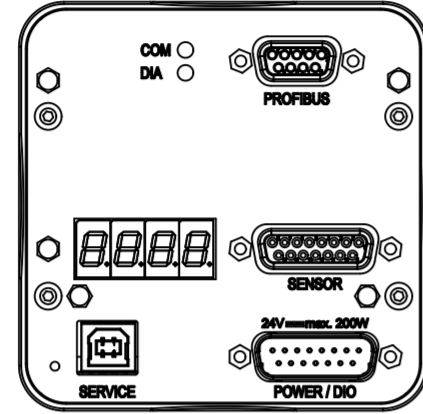

Profibus

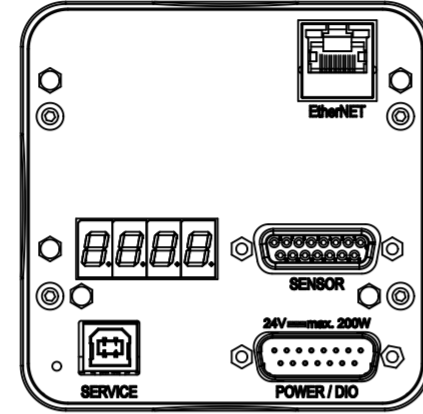

Ether NET

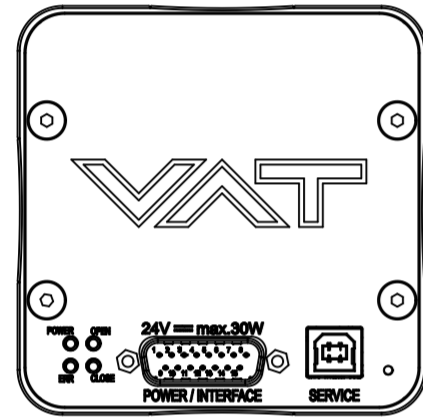

Position Only

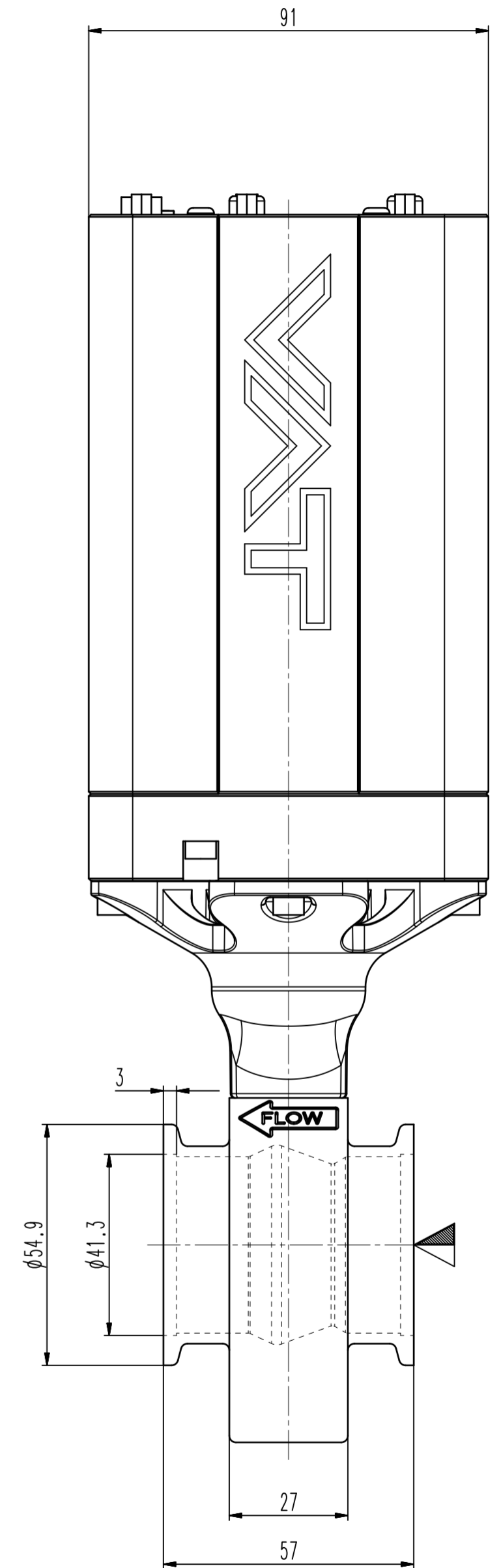
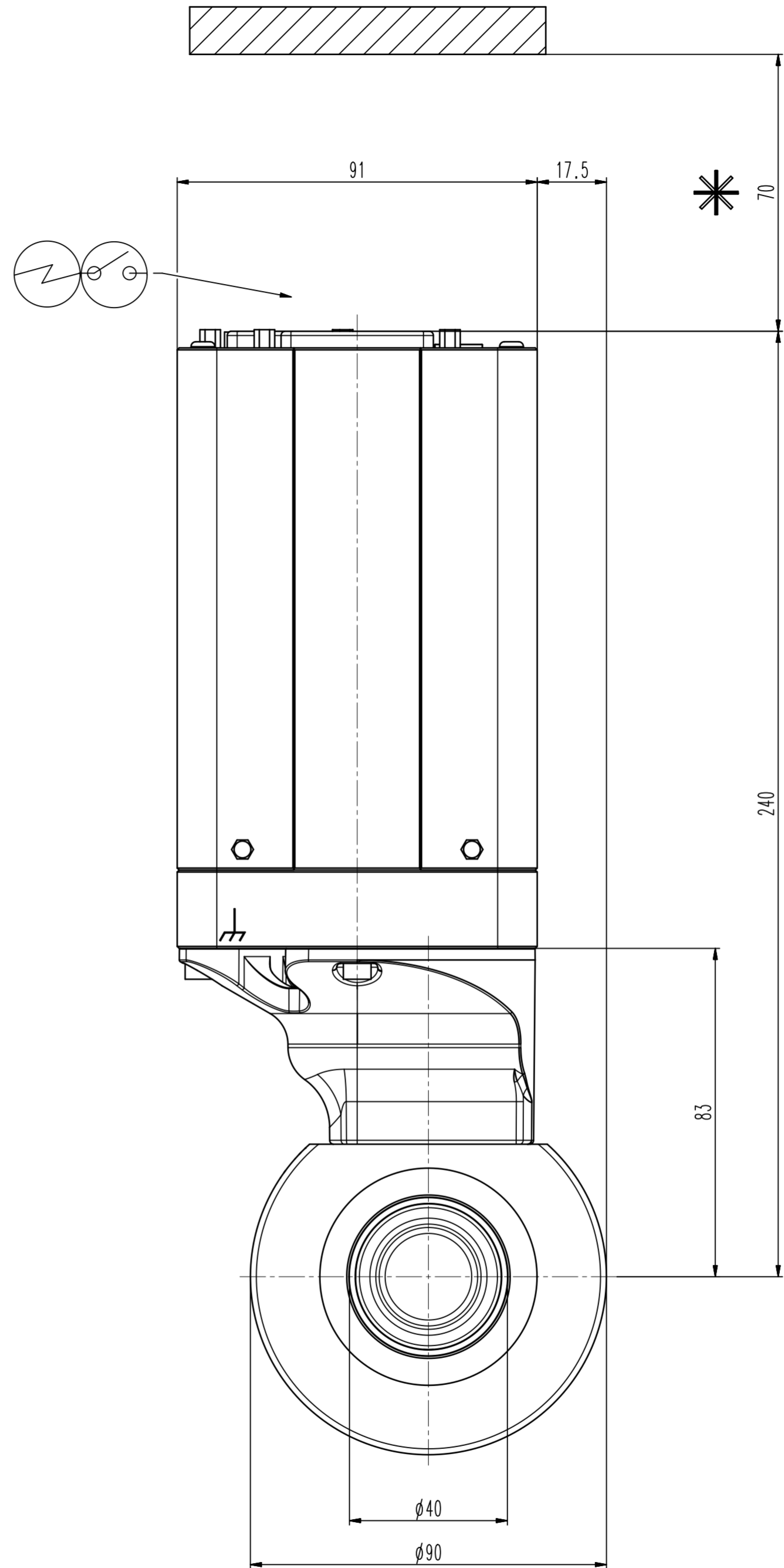
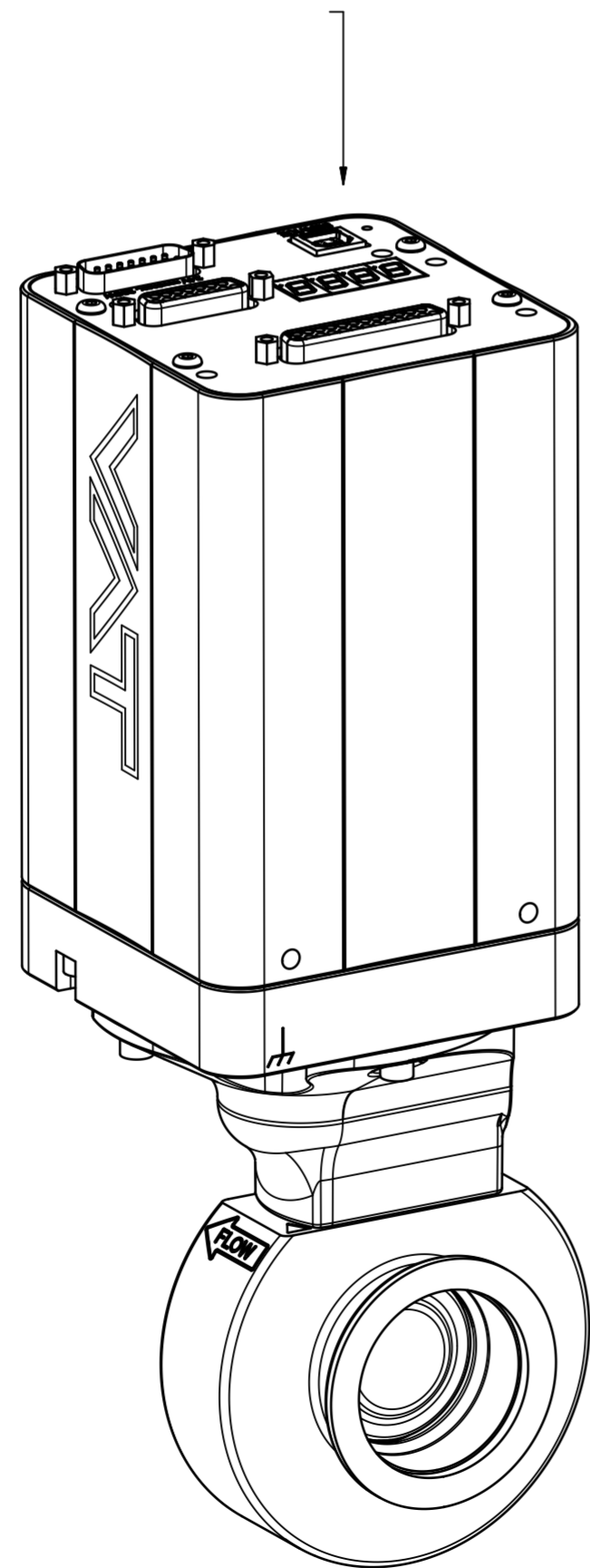

Revision

Customer number

- ▼ Seat side
- ⊙ Comp. air connection
- ⊙ Electrical connection
- ⊙ Leak detection port
- ⊙ Mech. pos. indication
- ⊙ Position indicator
- ⊙ Required for dismantling
- ⊙ Emergency actuation
- ⊙ For attachment
- ⊙ Bake-out area
- ⊙ Differential pumping port

Control butterfly system  
generic dimensional drawing for all 61.6 DN40 valves

**VAT** VAT Vakuumventile AG  
CH-9469 Haag, Switzerland  
Tel ++41 81 7716161 Fax ++41 81 7714830

Rev.-Date: 10.06.22  
Visa: HUS

Series	613	Ordering No.	-
Projection E	DN	Flange	
	40		
Dimensional Drawing	1166896	Rev.	A