

RS232 / RS485

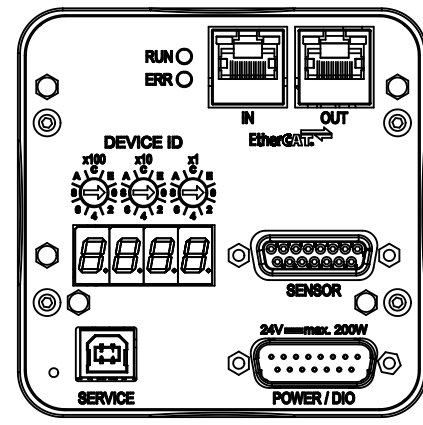

Ether CAT

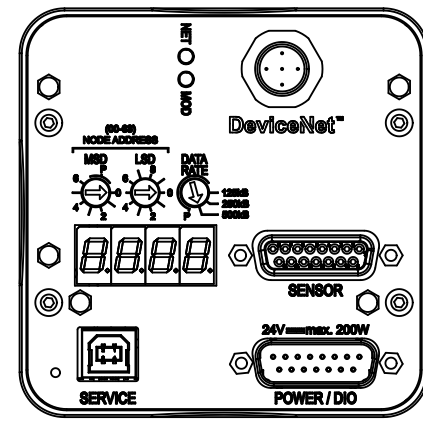

Device Net

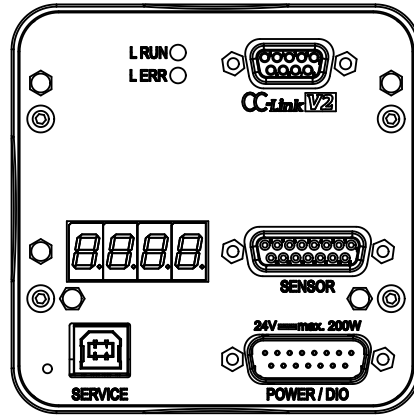

CC-Link

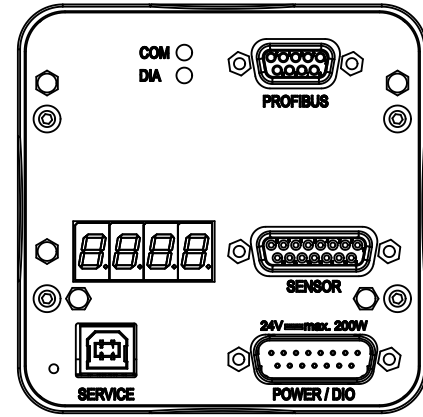

Profibus

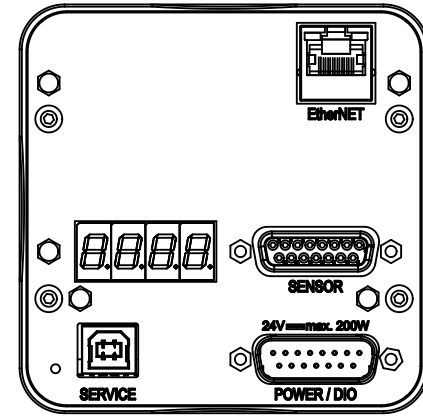

Ether NET

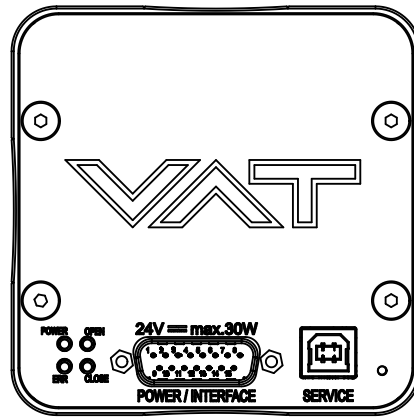

Position Only

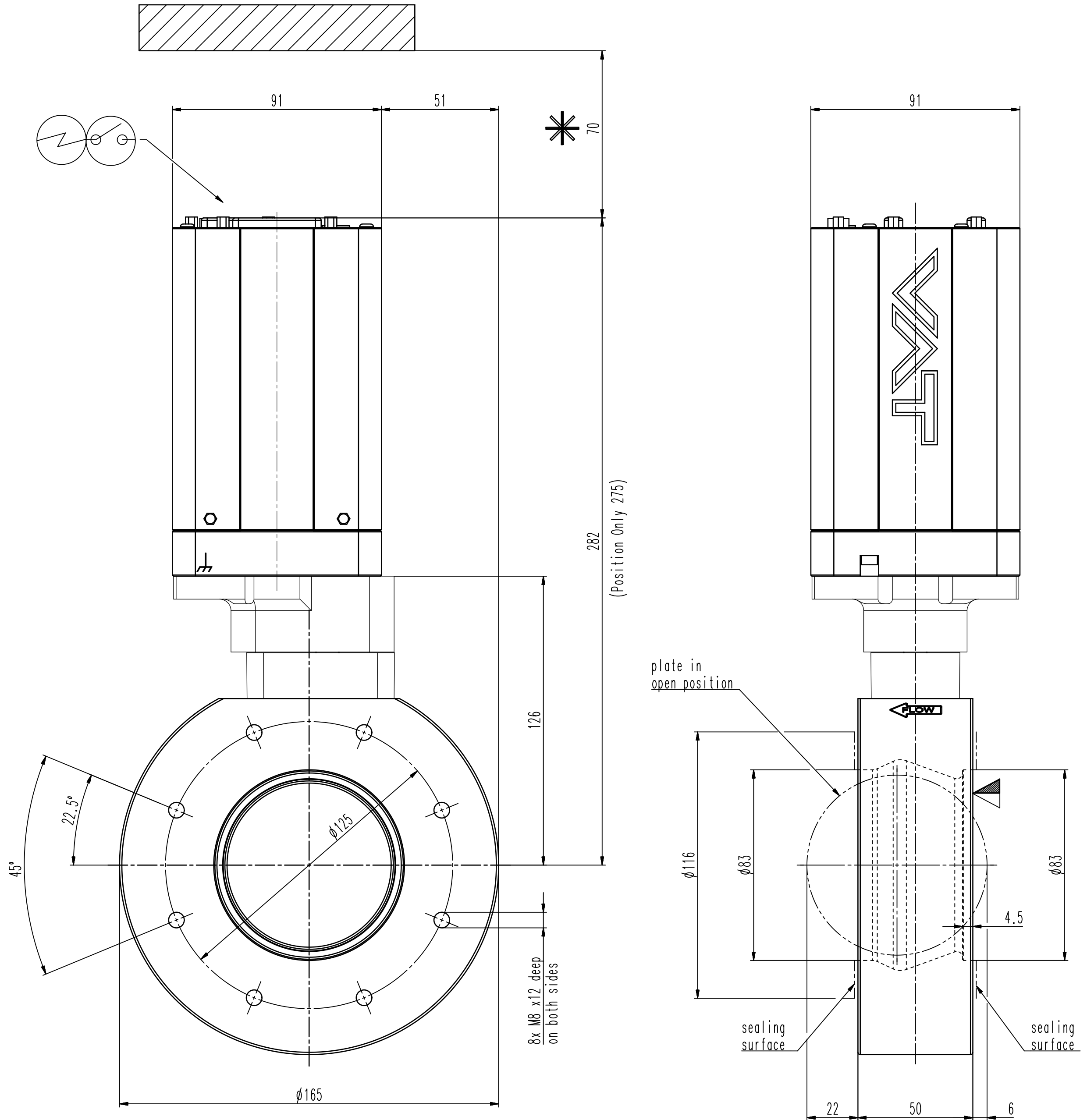
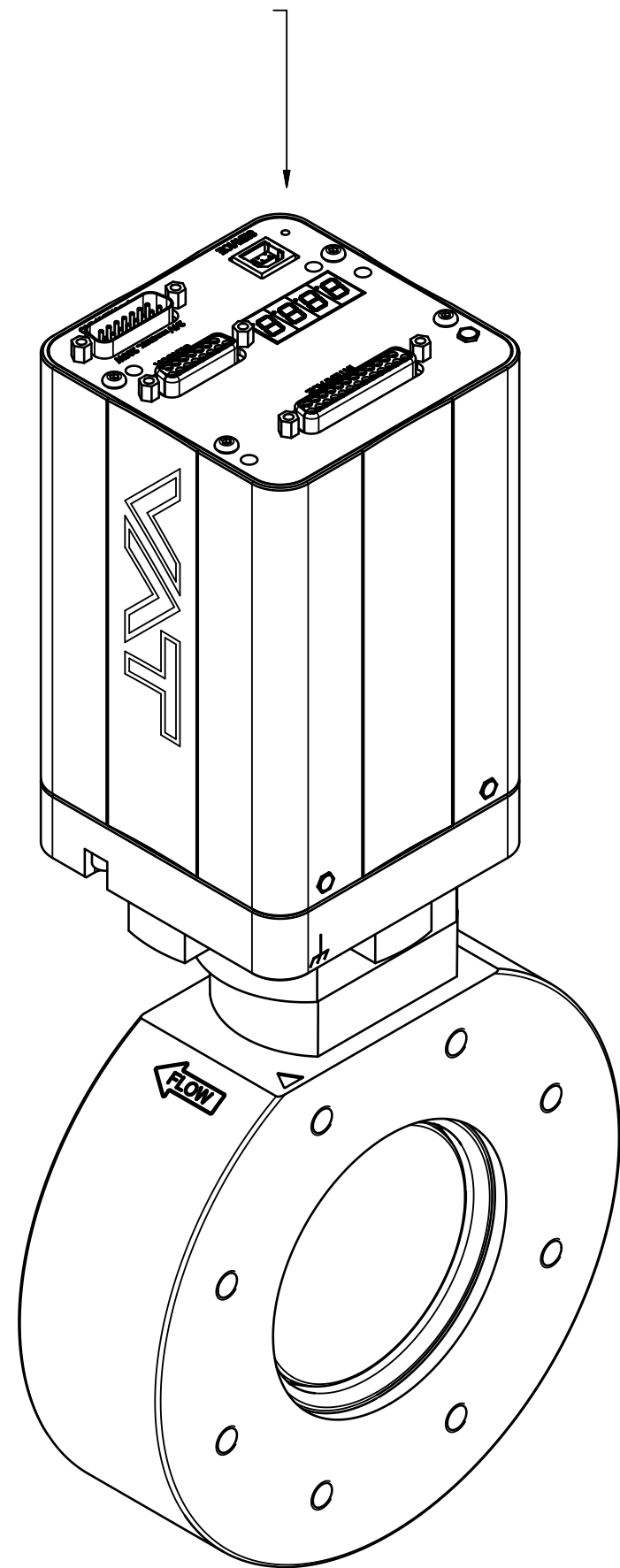

Revision

Customer number

- ▼ Seat side
- ⊕ Comp. air connection
- ⊕ Electrical connection
- ⊕ Leak detection port
- ⊕ Mech. pos. indication
- ⊕ Position indicator
- ⊕ Required for dismantling
- ⊕ Emergency actuation
- ⊕ For attachment
- ⊕ Bake-out area
- ⊕ Differential pumping port

Control butterfly with isolation function  
generic dimensional drawing for all 61.6 DN80 valves



VAT Vakuumventile AG  
CH-9469 Haag, Switzerland  
Tel. ++41 81 7716161 Fax ++41 81 7714830

Rev.-Date: 10.06.22  
Visa: HUS

Series	616	Ordering No.	-
Projection E	DN	Flange	
	80		
Dimensional Drawing	1166922	Rev.	A