

RS232 / RS485

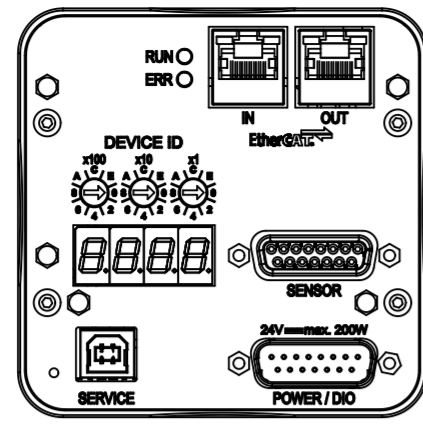

Ether CAT

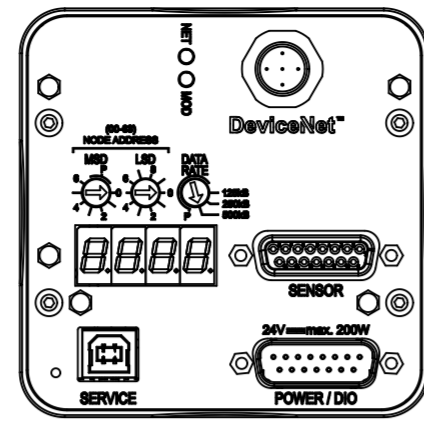

Device Net

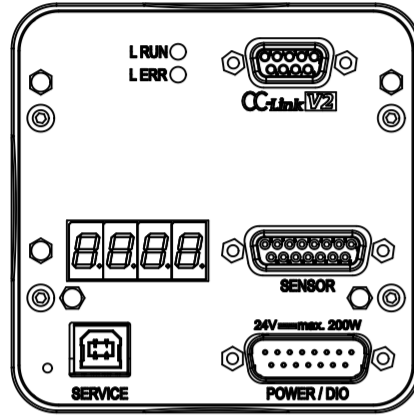

CC-Link

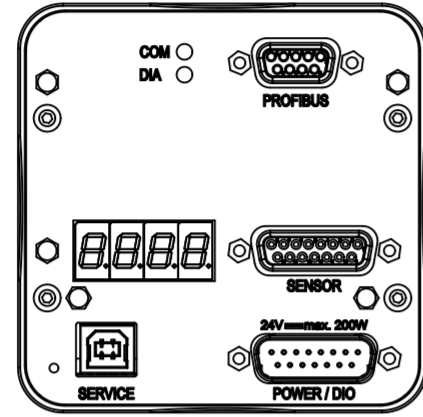

Profibus

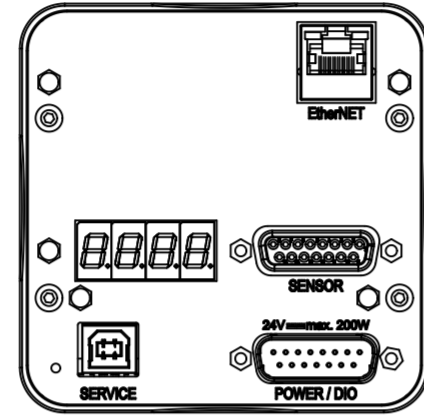

Ether NET

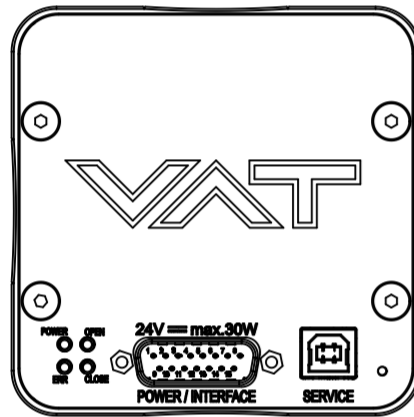

Position Only

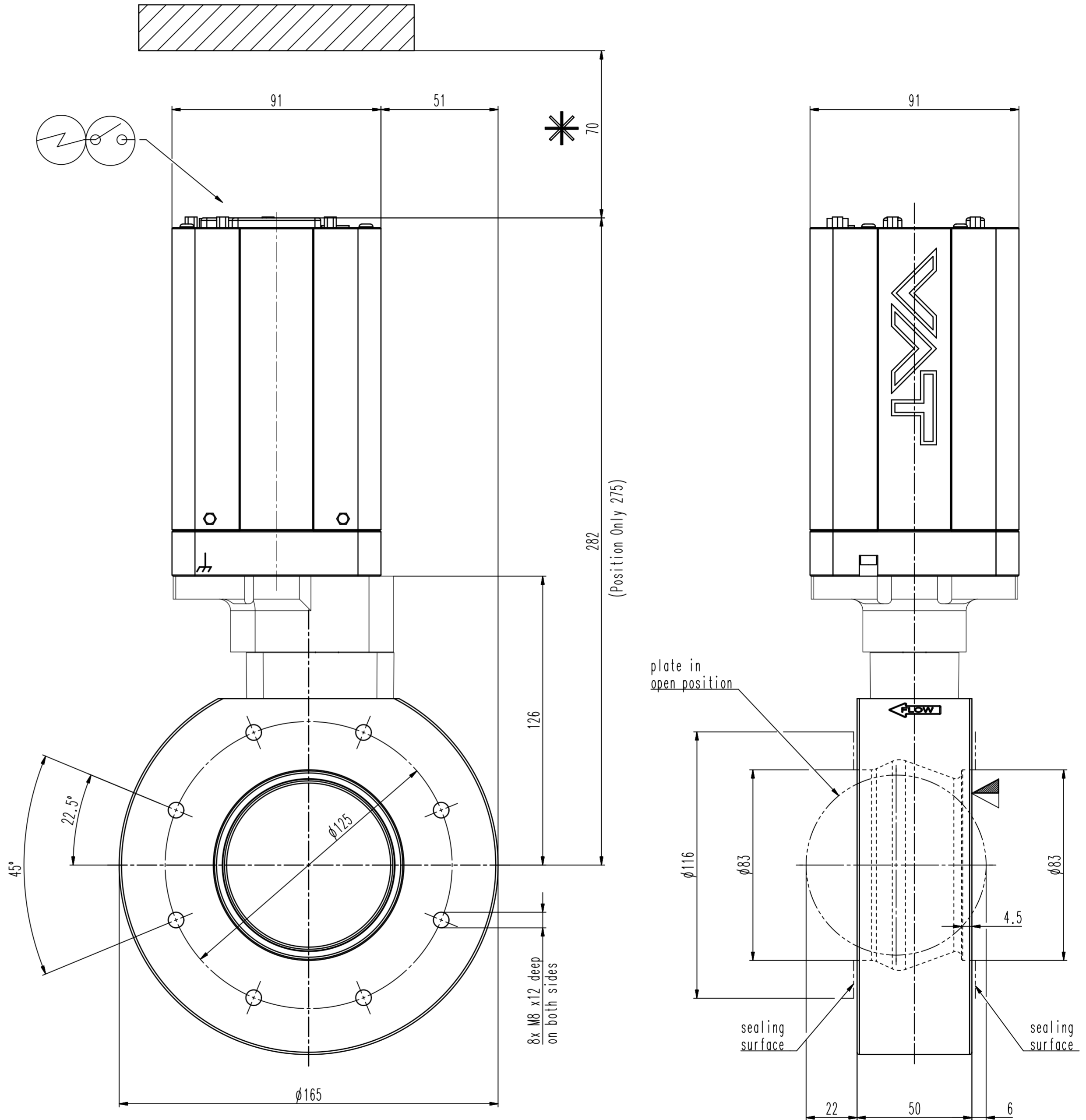
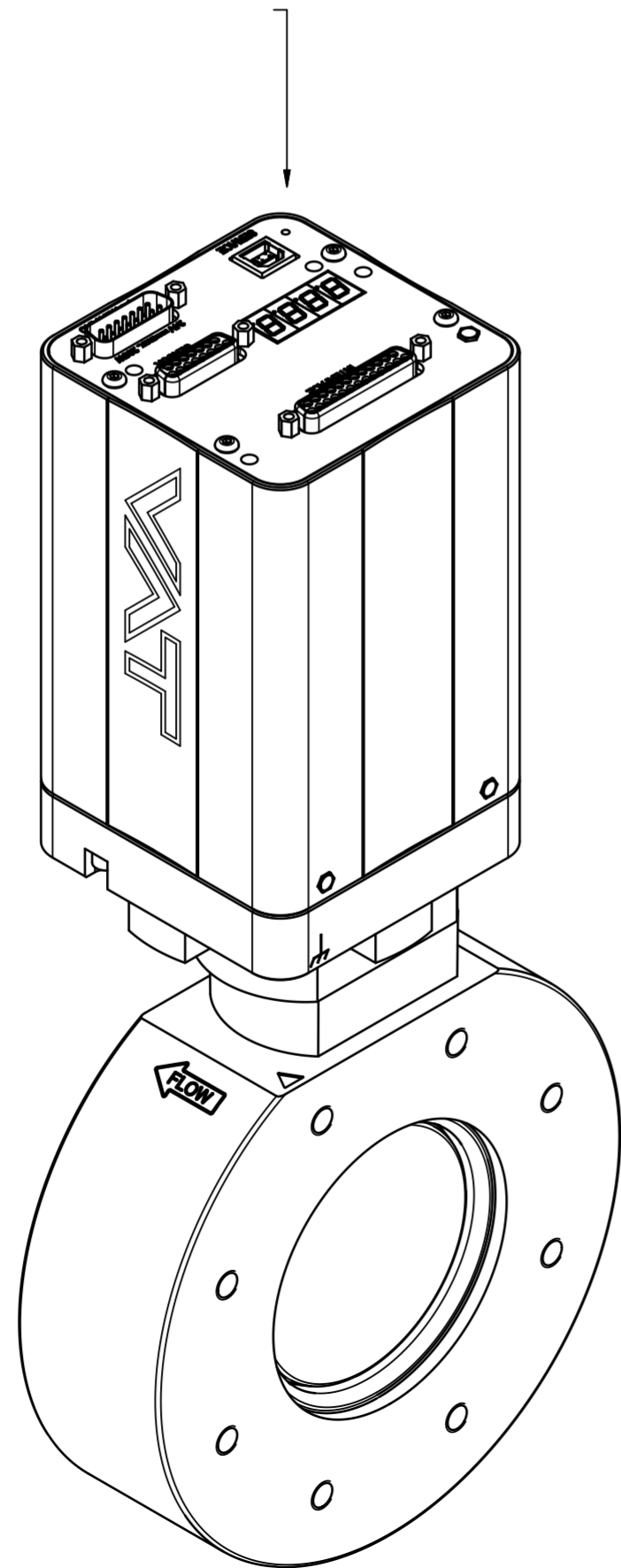

Revision

Customer number

- ▼ Seat side
- ⊙ Comp. air connection
- ⊙ Electrical connection
- ⊙ Leak detection port
- ⊙ Mech. pos. indication
- ⊙ Position indicator
- ⊙ Required for dismantling
- ⊙ Emergency actuation
- ⊙ For attachment
- ⊙ Bake-out area
- ⊙ Differential pumping port

Control butterfly with isolation function
generic dimensional drawing for all 61.6 DN80 valves



VAT Vakuumventile AG
CH-9469 Haag, Switzerland
Tel. ++41 81 7716161 Fax ++41 81 7714830

Rev.-Date: 10.06.22
Visa: HUS

Series	616	Ordering No.	-
Projection	E	DN	Flange
	80		
Dimensional Drawing	1166922	Rev.	A