

Control gate valve with Logic interface

Series 642 DN 200 mm (I.D. 8")

This manual is valid for the following product ordering numbers:

64246-UEHC-0001

Configured with firmware: **642P.2E.02**

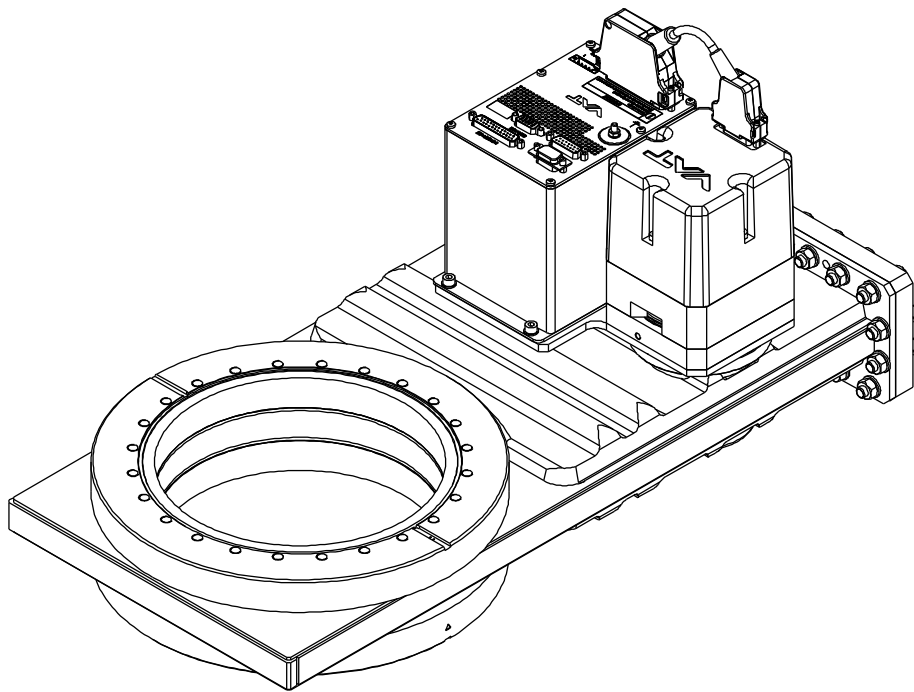

Sample picture

Imprint

Manufacturer VAT Vakuumventile AG, CH-9469 Haag, Switzerland

Website: www.vatvalve.com

Phone: +41 81 771 61 61

Fax: +41 81 771 48 30

Email: CH@vatvalve.com

Publisher VAT Vakuumventile AG, CH-9469 Haag, Switzerland

Editor VAT Vakuumventile AG, CH-9469 Haag, Switzerland

Print VAT Vakuumventile AG, CH-9469 Haag, Switzerland

Copyright © VAT Vakuumventile AG 2013

No part of these instructions may be reproduced in any way (photocopies, microfilms or any other reproduction processes) nor may it be manipulated with electronic systems, duplicated or distributed without written permission from VAT. Offenders are liable to pay damages.

The original VAT firmware and updated state of the art versions of the VAT firmware are intended for use with VAT products. The VAT firmware contains a limited, time unlimited user license. The VAT firmware may not be used for purposes other than those intended nor is it permitted to make copies of the VAT firmware. In particular, it is strictly forbidden to give copies of the VAT firmware to other people.

The use of trade names, brand names, trademarks, etc. in these Instructions does not entitle third parties to consider these names to be unprotected and to use them freely. This is in accordance with the meaning of the laws and acts covering brand names and trademarks.

Contents

1	Description of product.....	5
1.1	Identification of product	5
1.2	Use of product	5
1.3	Used abbreviations.....	5
1.4	Related documents	5
1.5	Important information.....	5
1.6	Technical data	6
1.6.1	Control and actuating unit	6
1.6.2	Valve unit	7
2	Safety	8
2.1	Compulsory reading material.....	8
2.2	Danger levels	8
2.3	Personnel qualifications.....	9
2.4	Safety labels.....	9
3	Design and Function.....	10
3.1	Design	10
3.2	Function.....	10
3.2.1	Pressure control system overview and function	11
3.2.2	Principle of a pressure control system	12
4	Installation	13
4.1	Unpacking	13
4.2	Installation into the system	14
4.2.1	Installation space condition	15
4.2.2	Connection overview.....	16
4.2.3	Installation procedure.....	17
4.3	Tightening torque	18
4.3.1	Mounting of CF-F flanges.....	18
4.4	Admissible forces	18
4.4.1	Requirements to sensor connection.....	19
4.5	Electrical connection.....	19
4.5.1	Ground connection.....	20
4.5.2	Sensor supply concepts	21
4.5.3	Power and sensor connection (+24 VDC sensors)	22
4.5.4	Power (+24 VDC) and sensor connection (± 15 VDC sensors) without SPS ...	24
4.5.5	Service port connection.....	25
4.5.6	Logic Interface Functions and Wiring.....	26
4.5.7	Digital inputs	28
4.5.8	Digital outputs	30
4.5.9	Analog inputs and outputs.....	31
4.6	Initial operation	32
4.6.1	Interface configuration.....	32
4.6.2	Valve configuration.....	33
4.6.3	Sensor configuration	33
4.6.4	ZERO	33
4.6.5	LEARN	34
4.6.6	Tuning of control performance	36
5	Operation	41
5.1	Normal operation.....	41
5.1.1	Local operation	42
5.1.2	Remote operation	43
5.2	Close valve.....	44

5.3	Open valve	44
5.4	Position control	44
5.5	Pressure control.....	44
5.6	Display information	45
5.6.1	Power up	45
5.6.2	Operation	46
5.6.3	Errors	46
5.6.4	Safety mode	46
5.6.5	Service indication	46
5.7	Operation during power up	47
5.8	Behavior in case of power failure.....	47
5.9	Operation under increased temperature	48
6	Trouble shooting	49
7	Maintenance.....	51
7.1	Maintenance intervals.....	51
7.2	Maintenance procedures	52
7.2.1	Replacement of gate seals and valve cleaning	52
7.2.2	Replacement of Option board	57
7.2.3	Retrofit / replacement procedure	59
8	Repairs	62
9	Dismounting and Storage.....	63
9.1	Dismounting.....	63
9.2	Storage	64
10	Packaging and Transport.....	65
10.1	Packaging.....	65
10.2	Transport	66
11	Disposal.....	67
12	Spare parts.....	68
12.1	Drawing	69
12.1.1	Valve unit with seals and grease	70
12.1.2	Control and actuating unit	71
12.1.3	Accessories.....	71
13	Appendix	72

1 Description of product

1.1 Identification of product

The fabrication number and order number are fixed on the product directly or by means of an identification plate.

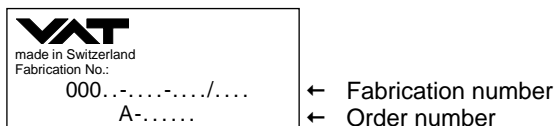

1.2 Use of product

This product is a control gate valve with isolation functionality. It is intended to use for downstream pressure control applications.
Use product for clean and dry vacuum applications only. Other applications are only allowed with the written permission of VAT.

1.3 Used abbreviations

Abbreviation	Description
CPA	Control Performance Analyzer
PFO	Power Failure Option
SFS	Sensor Full Scale
SPS	Sensor Power Supply
ADC	Analog-to-digital converter

1.4 Related documents

- Product Data Sheet
- Dimensional Drawing
- IOMI Heating device (if valve with heater)

1.5 Important information



This symbol points to a very important statement that requires particular attention.

Example:



Refer to chapter: «Technical data» for detailed information.

1.6 Technical data

1.6.1 Control and actuating unit

Description		
Input voltage ¹⁾	+24 VDC ($\pm 10\%$) @ 0.5 V pk-pk max.	[connector: POWER]
Power consumption	60 W	[connector: POWER]
Sensor power supply output ²⁾	+24 VDC / 1500 mA max.	[connector: SENSOR]
Sensor input Signal input voltage / Input resistance ADC resolution Sampling time	0-10 VDC / $R_i > 100 \text{ k}\Omega$ (linear to pressure) 0.23 mV 10 ms	[connector: SENSOR]
Digital inputs ³⁾	± 24 VDC max.	[connector: INTERFACE]
Digital outputs ³⁾ Input voltage Input current Breaking capacity	70 VDC or 70 V peak max. 0.5 ADC or 0.5 A peak max. 10 W max.	[connector: INTERFACE]
Analog outputs ³⁾ (optional)	0-10 VDC / 1 mA max.	[connector: INTERFACE]
PFO ⁴⁾ battery pack (optional) Charging time Durability	2 minutes max. up to 10 years @ 25°C ambient refer to «Durability of power fail battery» for details	
Compressed air supply	n/a	
Ambient temperature	0 °C to +50 °C max. (<35 °C recommended)	
Pressure control accuracy	5 mV or 0.1% of setpoint, whichever is greater	
Position resolution / position control capability	n/a (full stroke)	
Closing time throttling only	5 s typ.	
Opening time throttling only	5 s typ.	
Closing time throttling & isolation	6 s typ.	
Opening time throttling & isolation	6 s typ.	

¹⁾ Internal overcurrent protection by a PTC device.

²⁾ Refer to chapter «Sensor supply concepts» for details.

³⁾ Refer to chapter «Schematics» for details.

⁴⁾ PFO = Power Failure Option. Refer to «Behavior in case of power failure» for details.

1.6.2 Valve unit

Valve unit		
Pressure range at 20°C		1 × 10E-8 mbar to 2 bar (abs)
Leak rate to outside at 20°C		1 × 10E-9 mbar l/s
Leak rate valve seat at 20°C		1 × 10E-9 mbar l/s
Cycles until first service		
- Throttling cycles (open - max. throttle - open)		2'000'000 (unheated and under clean conditions)
- Isolation cycles (open - closed - open)		200'000 (unheated and under clean conditions)
Admissible operating temperature		+10°C to +150°C
Mounting position		valve sit (valve seat to face chamber is recommended)
Process side materials	body	Stainless steel 316L (1.4404 or 1.4435)
	plate	Stainless steel 316L (1.4404 or 1.4435)
	other parts	Aluminum: A356 (3.2371) Stainless steel: 301 (1.4310), 303 (1.4305), 304 (1.4301 or 1.4303), 316L (1.4435 or 1.4404), A2 (304)
Seals	plate	FKM (e.g. Viton®)
	rotary feedthrough	FKM (e.g. Viton®)
	bonnet (vulcanized)	FKM (e.g. Viton®)
Max. differential pressure on plate during isolation		2 bar in either direction
Max. differential pressure on plate during opening and throttling		30 mbar
Min. controllable conductance (N ₂ molecular flow)		2 l/s
Max. controllable conductance (N ₂ molecular flow)		12000 l/s
Dimensions		Refer to dimensional drawing of specific valve ordering number (available on request)

2 Safety

2.1 Compulsory reading material

Read this chapter prior to performing any work with or on the product. It contains important information that is significant for your own personal safety. This chapter must have been read and understood by all persons who perform any kind of work with or on the product during any stage of its serviceable life.

	NOTICE
	<p>Lack of knowledge Failing to read this manual may result in property damage. Firstly, read manual.</p>



These Installation, Operating & Maintenance Instructions are an integral part of a comprehensive documentation belonging to a complete technical system. They must be stored together with the other documentation and accessible for anybody who is authorized to work with the system at any time.

2.2 Danger levels

	⚠ DANGER
	<p>High risk Indicates a hazardous situation which, if not avoided, will result in death or serious injury.</p>

	⚠ WARNING
	<p>Medium risk Indicates a hazardous situation which, if not avoided, could result in death or serious injury.</p>

	⚠ CAUTION
	<p>Low risk Indicates a hazardous situation which, if not avoided, may result in minor or moderate injury.</p>

	NOTICE
	<p>Command Indicates a hazardous situation which, if not avoided, may result in property damage.</p>

2.3 Personnel qualifications

	! WARNING
	Unqualified personnel Inappropriate handling may cause serious injury or property damage. Only qualified personnel are allowed to carry out the described work.

2.4 Safety labels

Label	Part No.	Location on valve
	T-9001-156	On protective foil covering of valve opening

3 Design and Function

3.1 Design

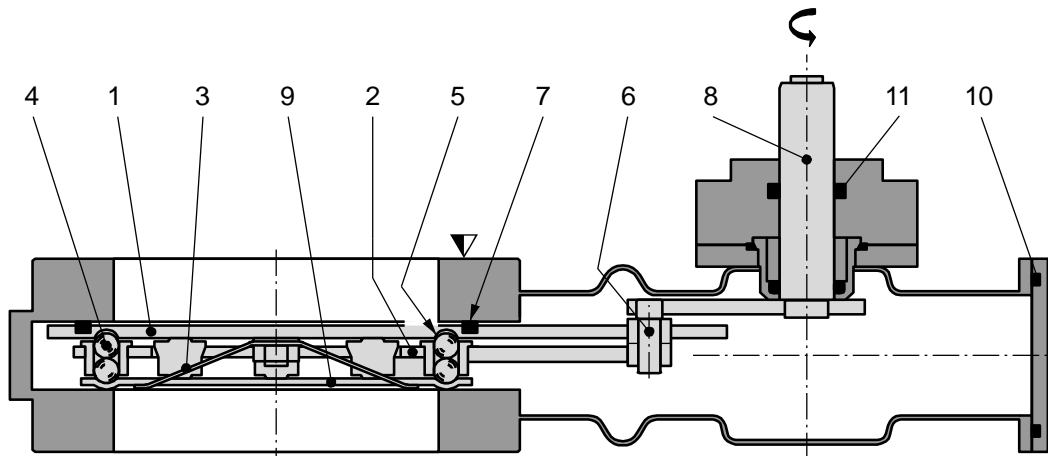

- | | | | |
|---|---------------|----|---------------------------|
| 1 | Valve gate | 7 | Gate seal |
| 2 | Ball guidance | 8 | Actuator shaft |
| 3 | Leaf spring | 9 | Counter plate |
| 4 | Ball pairs | 10 | Bonnet seal |
| 5 | Detents | 11 | Rotary feed through seals |
| 6 | Crank bolt | | |

3.2 Function

The valve gate (1) acts as a throttling element and varies the conductance of the valve opening. Actuation is performed with a stepper motor and controller. The stepper motor/controller version ensures accurate pressure control due to exact gate positioning. For leak tight closing the VATLOCK principle is applied. For details refer to VAT catalog.

3.2.1 Pressure control system overview and function

Vacuum pressures are always absolute pressures unless explicitly specified as pressure differences.

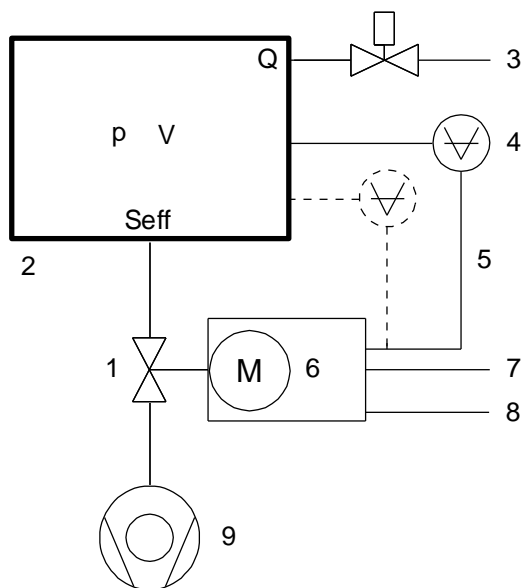

- 1 Valve
- 2 Process chamber
- 3 Gas inlet
- 4 Pressure sensor(s)
- 5 Sensor cable
- 6 Controller and actuator
- 7 Cable to remote control unit
- 8 Cable to power supply
- 9 HV Pump

$S_{eff} = Q / p$
 S_{eff} effective pump speed ($l s^{-1}$)
 Q Gas flow (mbar)
 p Pressure (mbar)

or units used in USA
 $S_{eff} = 12.7 \cdot Q / p$
 S_{eff} effective pump speed ($l s^{-1}$)
 Q Gas flow (sccm)
 p Pressure (mTorr)

Example: Downstream control

3.2.1.1 Way of operation

The controller compares the actual pressure in the process chamber given by the pressure sensor with the preset pressure. The controller uses the difference between actual and set pressure to calculate the correct position of the control valve. The controller drives the control valve into the correct position and the actual pressure again equals the set pressure.

This control operation is performed continuously. Pressure changes in the process chamber due to leaks, desorption, and gas flow, reaction products, variations in pumping speed etc. are always corrected at once.

3.2.1.2 Pressure control

In a vacuum system which is pumped and into which gas is admitted at the same time, the pressure can be controlled in two ways:

1. Downstream control (standard):
The pressure is controlled by changing the conductance of a control valve between pump and process chamber. This changes the effective pumping speed at the process chamber. Pressure and gas flow can be independently controlled over a wide range.
2. Upstream control:
The pressure is controlled by changing the gas flow into the process chamber, while the pumping speed remains constant.

3.2.1.3 Adaptive controller (standard)

A controller adapting itself to changes in pressure, gas flow and pumping speed without any manual adjustments. This allows for a completely automatic operation of the system.

3.2.2 Principle of a pressure control system

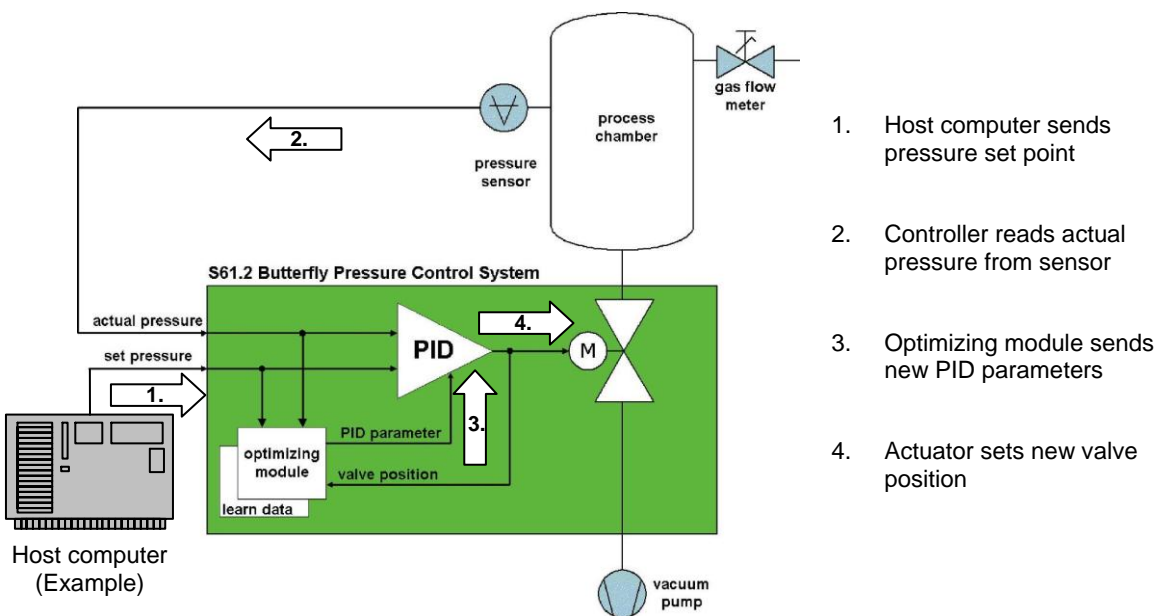

4 Installation

	⚠ WARNING
	Unqualified personnel Inappropriate handling may cause serious injury or property damage. Only qualified personnel are allowed to carry out the described work.

4.1 Unpacking

	NOTICE
	Physical overstraining at controller Inappropriate handling with the valve may cause in damage of controller. Do not place the valve on the controller.

	⚠ CAUTION
	Valve is a heavy component Physical overstraining. Use a crane to lift valves DN 200 (8") and larger.



- Make sure that the supplied products are in accordance with your order.
- Inspect the quality of the supplied products visually. If it does not meet your requirements, please contact VAT immediately.
- Store the original packaging material. It may be useful if products must be returned to VAT.

1. Open the transport case and remove inside packing material as far as necessary.
2. Attach lifting device for valves DN 200 (8") and larger. For attachment refer to dimensional drawing of valve.
3. Lift the valve carefully and place it on a clean place.



Do not remove protective foils from valve opening

4.2 Installation into the system

	WARNING
	<p>Valve opening Risk of serious injury. Human body parts must be kept out of the valve opening and away from moving parts. Do not connect the controller to power before the valve is installed complete into the system.</p>

	NOTICE
	<p>Sealing surfaces Sealing surfaces of valve and vacuum system could be damage in case of incorrect handling. Only qualified personal are allowed to install the valve into the vacuum system.</p>

	NOTICE
	<p>Wrong connection Wrong connection may result in damage of controller or power supply. Connect all cables exactly as shown in the following descriptions and schematics.</p>

	NOTICE
	<p>Burned connector pins (spark) Connector pins or electronic parts could damage, if plugged and unplugged under power. Do not plug or unplug connectors under power.</p>

	NOTICE
	<p>Contamination Gate and other parts of the valve must be protected from contamination. Always wear clean room gloves when handling the valve.</p>

Mount valve to a clean system only.

4.2.1 Installation space condition



Install the valve with integrated controller with space for dismantling and air circulation as shown in figure below.

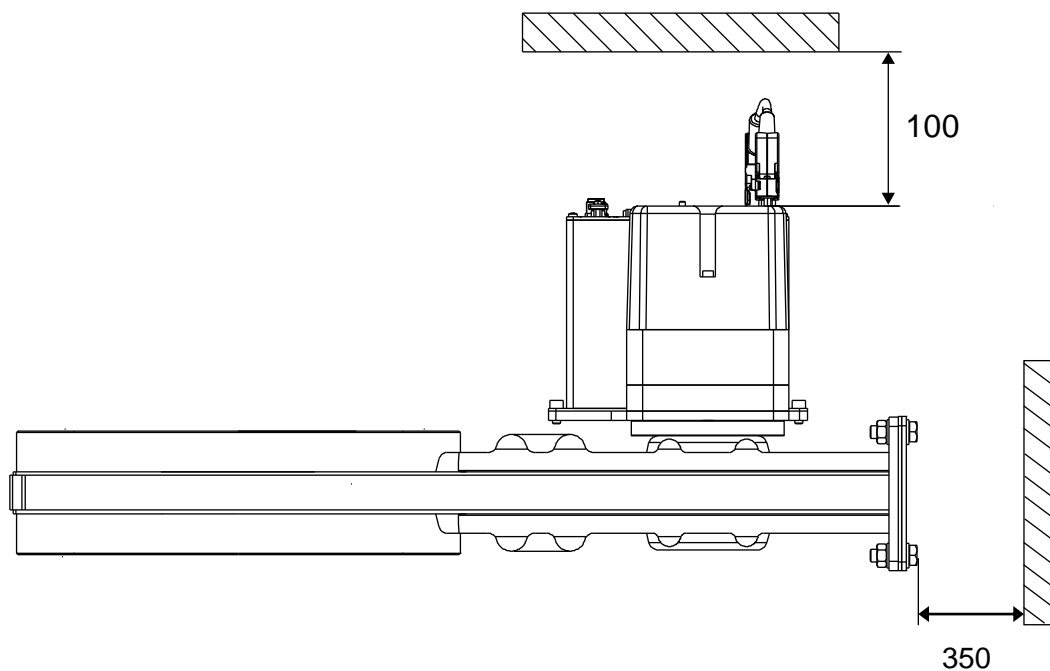

sample picture

4.2.2 Connection overview

System:

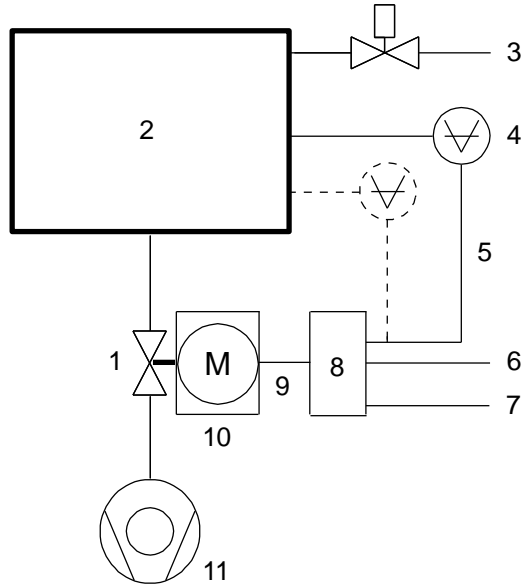

- 1 Valve
- 2 Process chamber
- 3 Gas inlet
- 4 Pressure sensor(s)
- 5 Sensor cable(s)
- 6 Cable to Logic remote control unit
- 7 Cable to power supply
- 8 Controller
- 9 Connection cable controller / actuator
- 10 Actuator
- 11 Pump

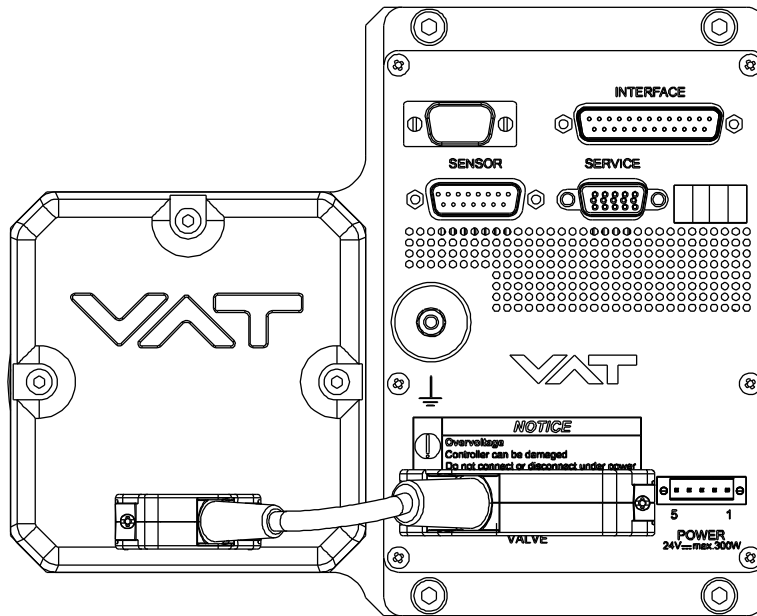

Actuator

Controller

4.2.3 Installation procedure

1. Install valve [1] into the vacuum system.



- Do not tighten the flange screws stronger than indicated under «Tightening torque».
- Do not admit higher forces to the valve than indicated under «Admissible forces».
- Make sure that enough space is kept free to do preventive maintenance work. The required space is indicated on the dimensional drawing.

2. Install the ground connection cable at controller. Refer to «Electrical connection»
3. Install connection cable between actuator (connector) and controller (connector: VALVE)
4. Install sensor(s) [4] according to the recommendations of the sensor manufacturer and directives given under «Requirements to sensor connection».
5. Connect pressure sensor cable [5] to sensor(s) and then to valve (connector: SENSOR). Refer to chapter «Electrical connection» for correct wiring.



Input for second sensor is available on 642 H - version only.

6. Connect valve to Logic Interface [6] (Logic connector). Refer to «DeviceNet schematics» for correct wiring.
7. Connect power supply [7] to valve (connector: POWER). Refer to chapter «Electrical connection» for correct wiring.



To provide power to the valve motor pins 4 and 8 must be bridged, otherwise motor interlock is active and the valve enters the safety mode and is not operative. Refer also to «Safety mode».

8. This valve may optionally be equipped with a heating device. Connect VAT heating device according to manual of respective heating device.
9. Perform «Setup procedure» to prepare valve for operation.



Without performing the setup procedure the valve will not be able to do pressure control.

4.3 Tightening torque

4.3.1 Mounting of CF-F flanges

Tightening torques for CF-F flange connections depends on the type of seal which is used. Follow recommendations of seal manufacturer.

4.4 Admissible forces

	NOTICE
	<p>Force at flange and valve body</p> <p>Forces from evacuating the system, from the weight of other components, and from baking can lead to deformation and malfunctioning of the valve.</p> <p>Do not higher force the valve body as specified.</p>



The following forces are admissible.

Axial tensile or compressive force «F _A »		Bending moment «M»	
N	lb.	Nm	lbf.
2940	660	147	108

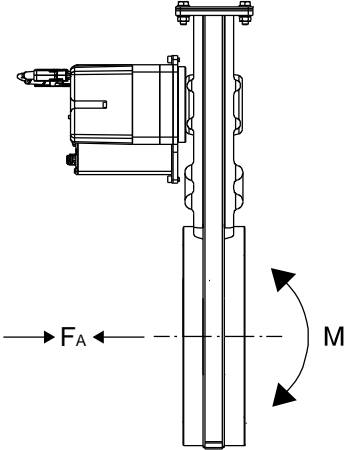

For a combination of both forces (F_A and M) the values are invalid.
Verify that the depth of the mounting screws is min. 1 × thread diameter.
Please contact VAT for more information.

4.4.1 Requirements to sensor connection

To achieve fast and accurate pressure control a fast sensor response is required. Sensor response time: < 50ms. The sensor is normally connected to the chamber by a pipe. To maintain that the response time is not degraded by this connection it needs to meet the following requirements:

- Inner diameter of connection pipe: $\geq 10 \text{ mm}$
- Length of connection pipe: $\leq 300 \text{ mm}$

These conductance guidelines must include all valves and limiting orifices that may also be present. Make also sure that there is no obstruction in front of sensor connection port inside the chamber. The sensor should also be mounted free of mechanical shock and vibration. Dynamic stray magnetic fields may introduce noise to sensor output and should be avoided or shielded.

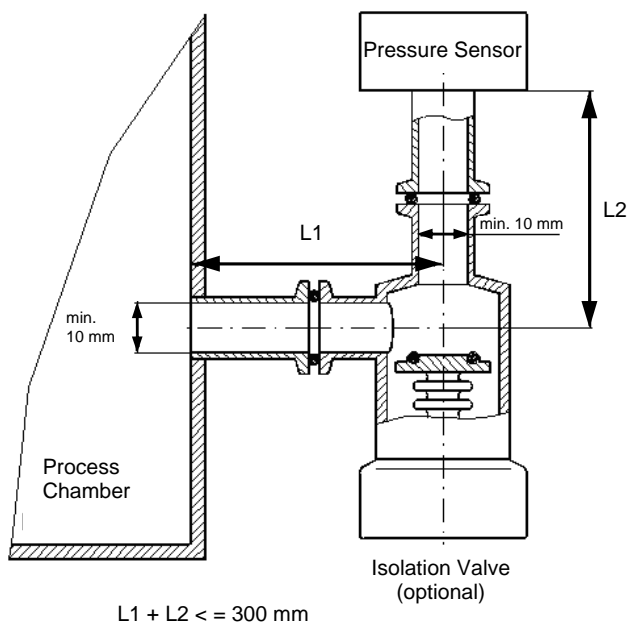

4.5 Electrical connection

	NOTICE
<p>Wrong connection</p> <p>Wrong connection may result in damage of controller or power supply. Connect all cables exactly as shown in the following descriptions and schematics.</p>	
	NOTICE
<p>Burned connector pins (spark)</p> <p>Connector pins or electronic parts could damage, if plugged and unplugged under power. Do not plug or unplug connectors under power.</p>	

4.5.1 Ground connection

Recommendation for ground strap between controller ground and system chassis.

Material	L (Length max.)	B1 (min.)	B2 (min.)	d1 (∅)	d2 (∅)
copper tinned	200 mm	25 mm	25 mm	4.5 mm	customized

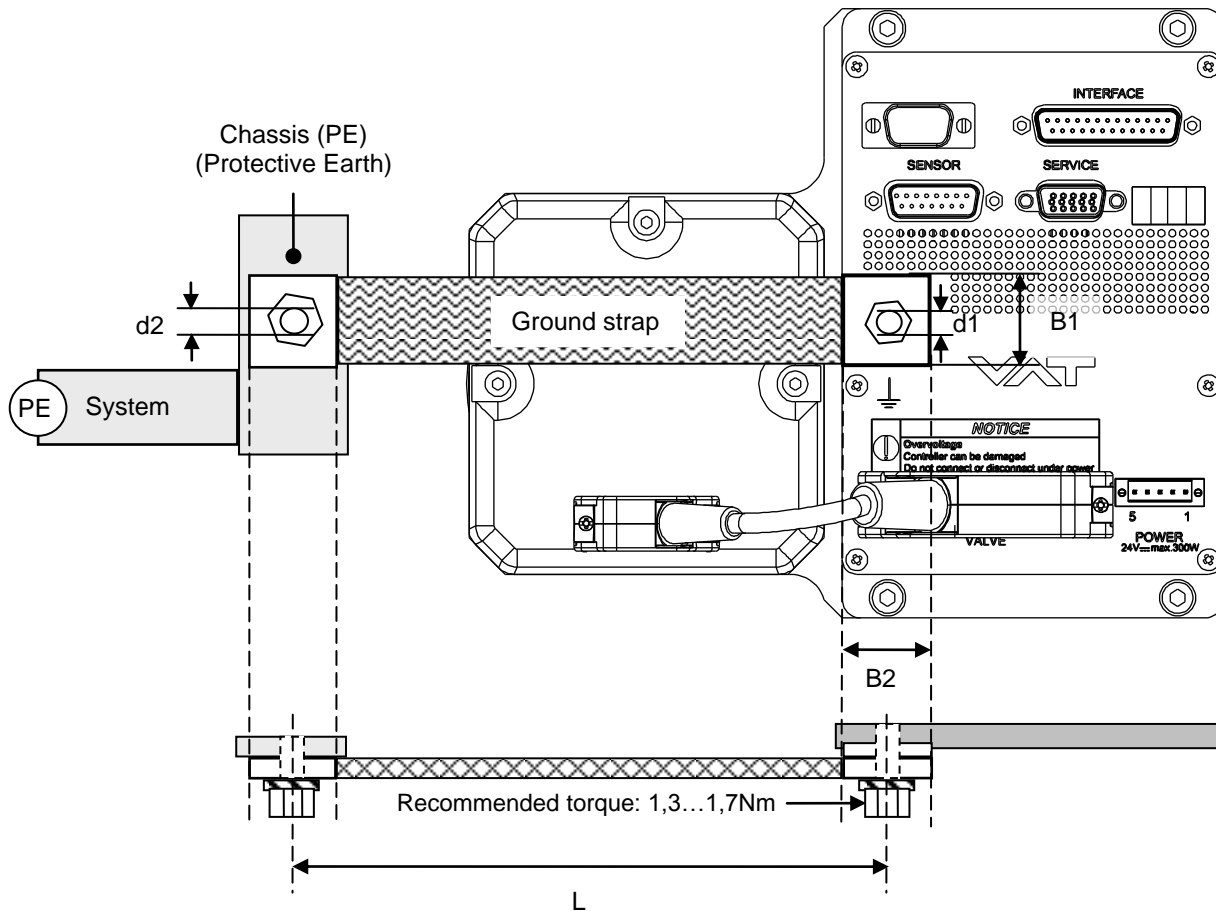

- Connection plates of ground strap must be total plane for a good electrical contact!
- The connection point at chassis (FE) must be blank metal (not coated). It is also possible to connect the ground strap at system chamber if it is well connected to PE.
- Avoid low chassis cross section to the system PE connection. (min. same cross section as ground strap)

4.5.2 Sensor supply concepts

This valve offers 3 alternative concepts to supply the sensor(s) with power. This depends on the sensor type and valve version that is used. This valve is available with an optional sensor power supply module (SPS) that converts ± 15 VDC from the 24 VDC.

Concepts:

- External +24 VDC supplied to POWER connector is feedthrough to SENSOR connector to supply 24 VDC sensors. Refer to chapter «Power and sensor connection (+24 VDC sensors)» for schematic and correct wiring.
- External ± 15 VDC supplied to POWER connector is feedthrough to SENSOR connector to supply ± 15 VDC sensors. Refer to chapter «Power and sensor connection (± 15 VDC sensors) without optional SPS module» for schematic and correct wiring.
- External +24 VDC supplied to POWER connector is converted into ± 15 VDC by the valve internal SPS and supplied to SENSOR connector to supply ± 15 VDC sensors. Refer to chapter «Power and sensor connection (± 15 VDC sensors) with optional SPS module» for schematic and correct wiring.



This concept is only possible when SPS retrofit is installed.

Valve versions:

- 642 **G** and 642 **H** SPS module not included
- 642 **A** and 642 **C** SPS module included



The SPS module can be retrofitted. Refer to chapter «Retrofit / replacement procedure» for instruction.

4.5.3 Power and sensor connection (+24 VDC sensors)

[642 G / 642 H versions recommended]

4.5.3.1 Sensor power wiring via controller

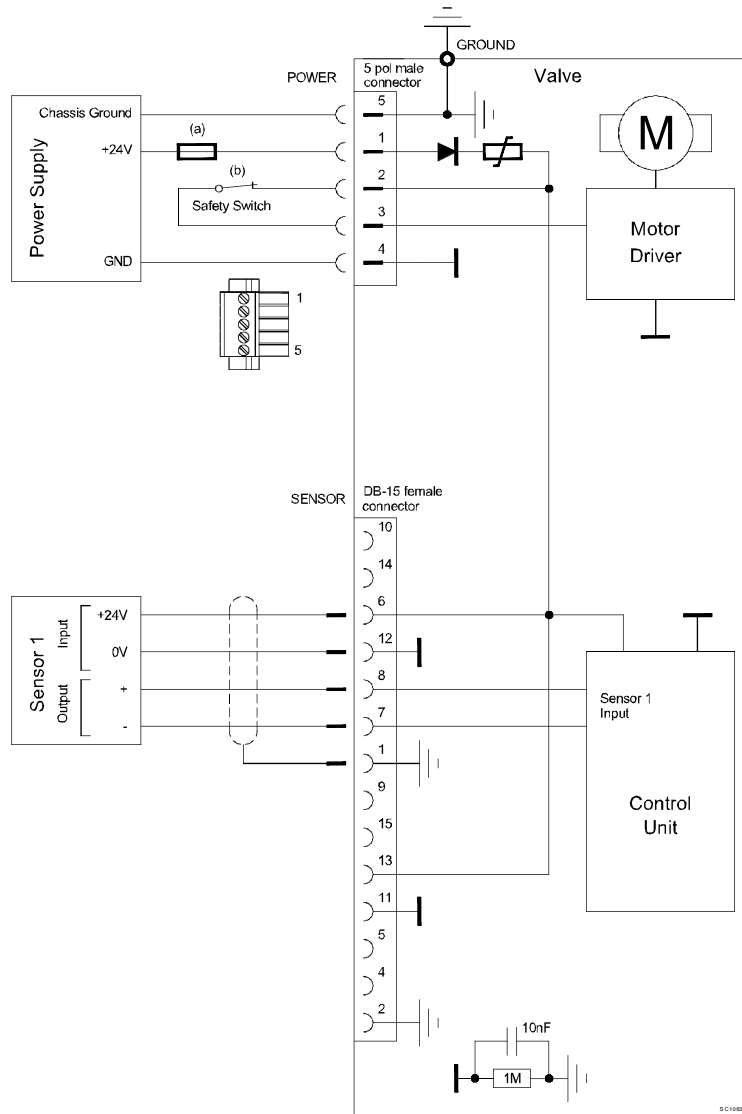

Pins 2 and 3 must be bridged for operation. An optional switch would allow for motor interlock to prevent valve from moving.



- **VAT fuse recommendation: (a) 5AF, (b) min. 3A**
- Use shielded sensor cable(s). Keep cable as short as possible, but locate it away from noise sources.
- Connect Power supply (+24 / GND) at power 5 pol. male connector and Sensors (+24V / 0V / + / -) at DB-15 female sensor connector exactly as shown in the drawing above!

4.5.3.2 Sensor power wiring external

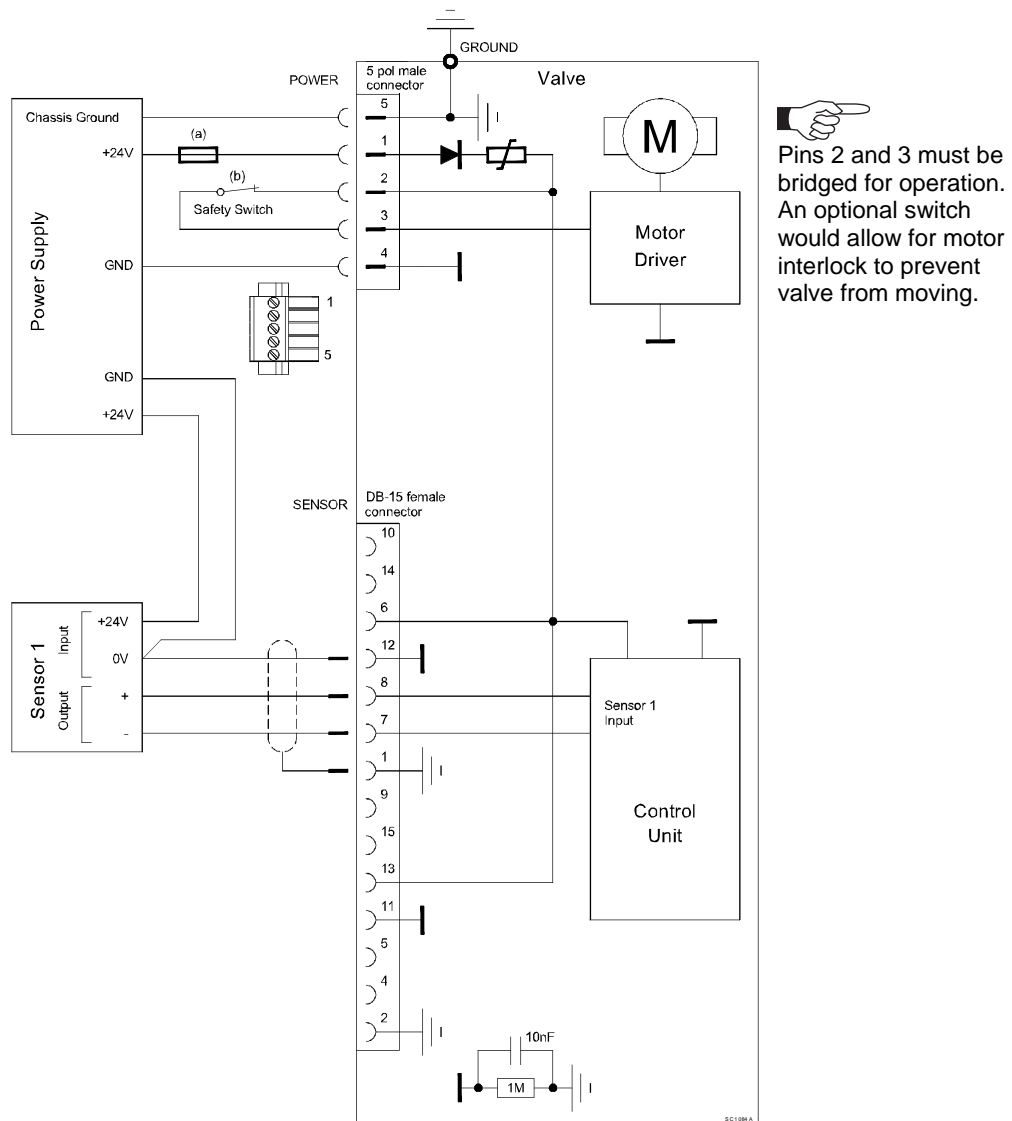

- **VAT fuse recommendation: (a) 5AF, (b) min. 3A**
- Use shielded sensor cable(s). Keep cable as short as possible, but locate it away from noise sources.
- Connect Power supply (+24 / GND) at power 5 pol. male connector and Sensors (0V / + / -) at DB-15 female sensor connector exactly as shown in the drawing above!

4.5.4 Power (+24 VDC) and sensor connection (± 15 VDC sensors) without SPS

[642 G / 642 H versions only]

4.5.4.1 Sensor power wiring external

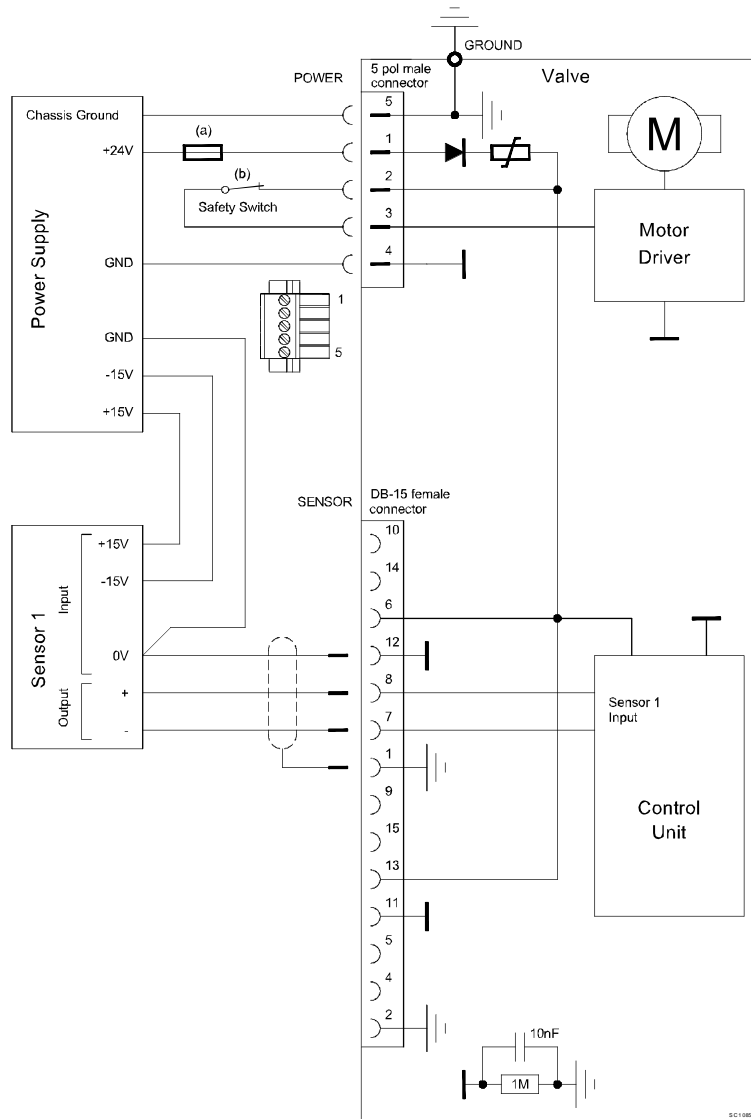

Pins 4 and 8 must be bridged for operation. An optional switch would allow for motor interlock to prevent valve from moving.



- **VAT fuse recommendation: (a) 5AF, (b) min. 3A**
- Use shielded sensor cable(s). Keep cable as short as possible, but locate it away from noise sources.
- Connect Power supply (+24 / GND) at power 5 pol. male connector and Sensors (0V / + / -) at DB-15 female sensor connector exactly as shown in the drawing above!

4.5.5 Service port connection

The service port (connector: SERVICE) allows to connect the valve to a RS232 port of a computer. This requires a service cable and software from VAT.

You can use our Software (freeware) 'Control Performance Analyzer' which can be downloaded from: <http://www.vatvalve.com/customer-service/informations-and-downloads/control-performance-analyzer>.

Alternatively the VAT Service Box2 can be connected to the service port for setup and local operation.

The service port is not galvanic isolated. Therefore we recommend using this only for setup, testing and maintenance and not for permanent control.

Refer also to chapter: «Local Operation» for details and to chapter «Spare parts / Accessories» for ordering numbers of service cable, software and Service Box 2.



Use only screws with 4–40 UNC thread for fastening the service port connector.

4.5.6 Logic Interface Functions and Wiring



Logic interface allows for remote operation by means of digital and analog signals. Digital inputs may be operated either by switches or by voltage sources.

a) Configuration with switches for digital inputs:

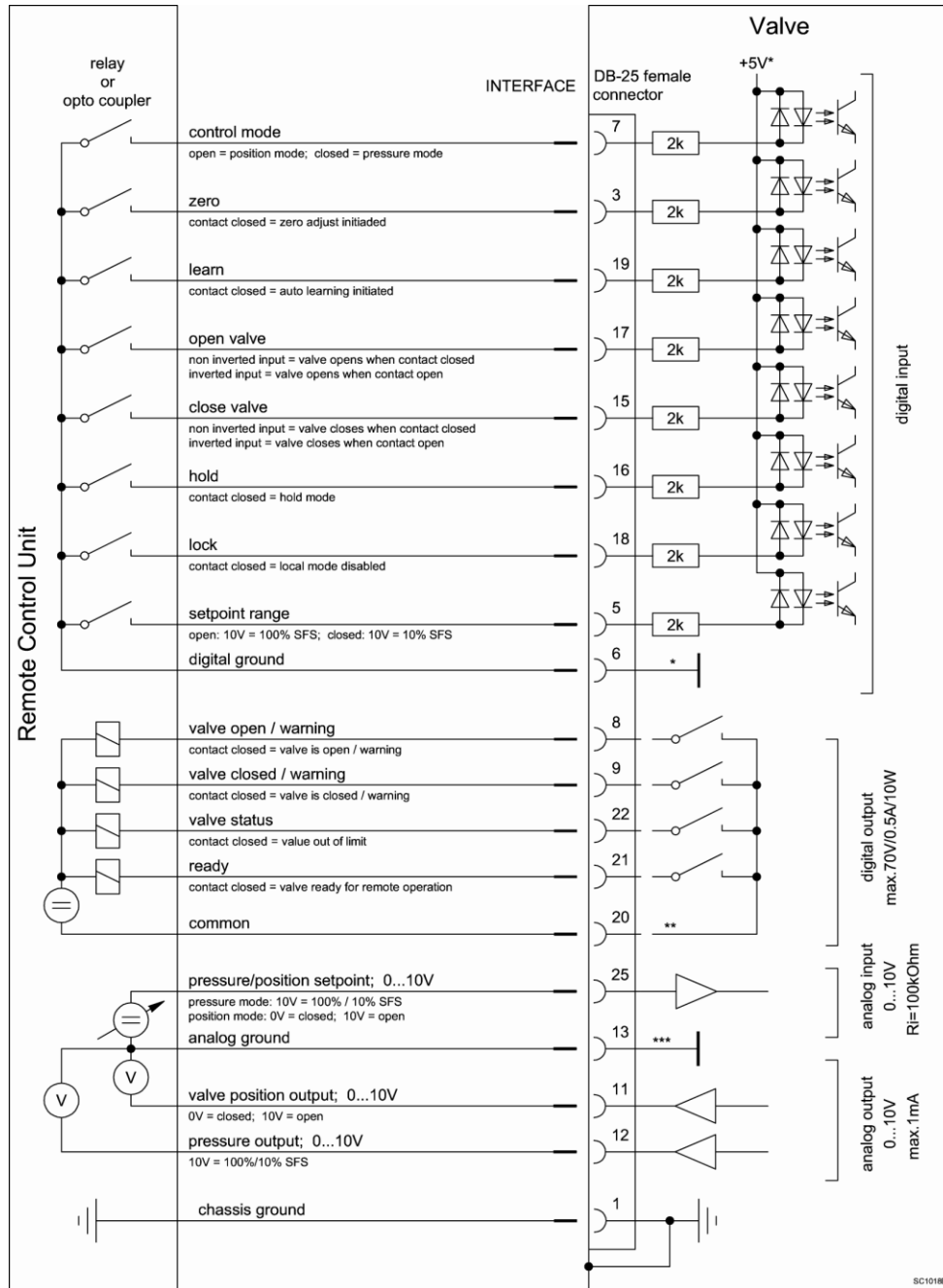

Do not connect other pins than indicated in the schematics above!
Use only screws with 4-40UNC thread for fastening the DB-25 connector!

b) Configuration with voltage source for digital inputs:

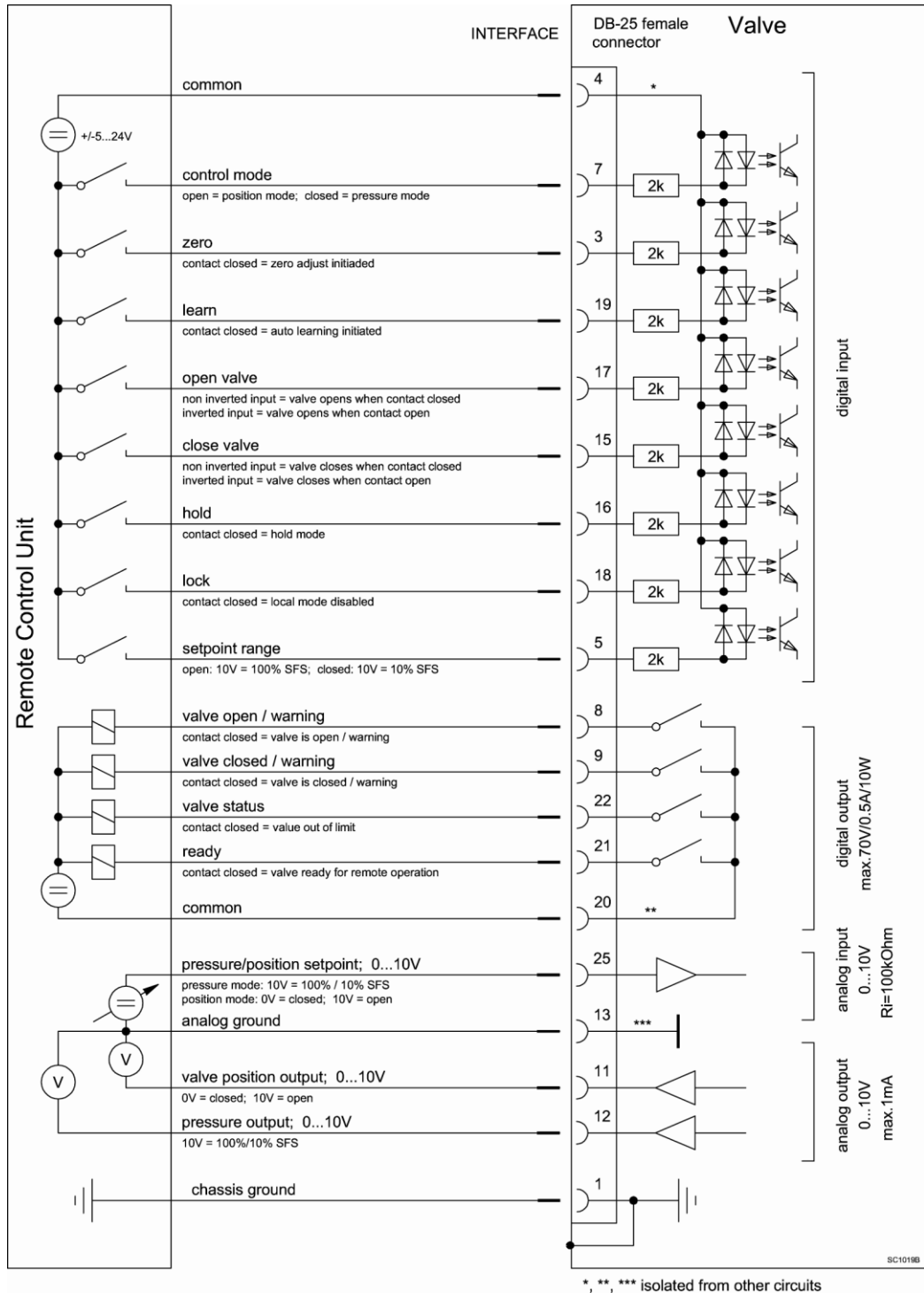



Do not connect other pins than indicated in the schematics above!
Use only screws with 4-40UNC thread for fastening the DB-25 connector!

4.5.7 Digital inputs

Pin	Function	Signal type	Description	Priority
7	CONTROL MODE	Digital Input ¹⁾	<p>This pin selects the control mode. This valve may either be operated as pressure controller or as position controller.</p> <p><u>PRESSURE CONTROL</u> is activated as long as optocoupler is 'on'. The PID controller controls the chamber pressure according to the pressure SETPOINT by means of the valve position.</p> <p><u>POSITION CONTROL</u> is activated when optocoupler is 'off'. The valve position is directly controlled according to the position SETPOINT.</p>	6 ²⁾
5	SETPOINT RANGE	Digital input ¹⁾	<p>This pin selects the SETPOINT RANGE. Low range extension is activated as long as optocoupler is 'on'. It's effective in pressure control mode only.</p> <p>This function extends the lower 10% range of sensor full scale (SFS) to the full 0-10V for SETPOINT input. Herewith you can achieve better resolution, especially in case of a 2 sensor system.</p> <p>Example with SFS = 100mTorr: Not active (10V=100%) >> 10V setpoint = 100mTorr Active (10V=10%): >> 10V setpoint = 10mTorr</p>	N/A
16	HOLD	Digital input ¹⁾	<p>This function stops the valve at the current position. After release of the signal the valve will return to the selected CONTROL MODE. Only PRESSURE or POSITION Mode.</p> <p>This function is activated as long as optocoupler is 'on'.</p>	5 ²⁾
17	OPEN VALVE	Digital input ¹⁾	<p>This function will open the valve.</p> <p>This function is activated as long as optocoupler is 'on' in non inverted configuration.</p> <p>This function is activated as long as optocoupler is 'off' in inverted configuration.</p> <p>Configuration can be done in local operation via service port. Default settings is not inverted</p>	3 ²⁾
15	CLOSE VALVE	Digital input ¹⁾	<p>This function will close the valve.</p> <p>This function is activated as long as optocoupler is 'on' in non inverted configuration.</p> <p>This function is activated as long as optocoupler is 'off' in inverted configuration.</p> <p>Configuration can be done in local operation via service port. Default settings is not inverted</p>	2 ²⁾

- 1) All digital inputs are digitally filtered. Filter delay is 50ms. This means that digital signals must be applied for at least 50ms to be effective. Refer to «Function and wiring» for details about input circuit.
- 2) Highest priority is 1. Functions with lower priorities will not be effective as long as higher priority functions are active.

Pin	Function	Signal type	Description	Priority
3	ZERO	Digital Input ¹⁾	<p>This function compensates the pressure gauge offset voltage and sets the pressure value to zero. In case of a 2 sensor system both sensor inputs will be adjusted.</p> <p>This function is initiated by the 'off' to 'on' transition of the optocoupler.</p> <p>If 'on' remains established this will not re-initiate the function and does also not block functions with lower priorities.</p> <p> Do not perform ZERO as long as pressure gauge voltage is shifting.</p> <p>Do not perform ZERO, if the base pressure of your vacuum system is higher than 1‰ of sensor full scale. We recommend disabling ZERO function in this case. You can disable the function in local operation via service port.</p>	1 ²⁾
19	LEARN	Digital Input ¹⁾	<p>The LEARN routine determines the control characteristic of the vacuum system.</p> <p>This function is initiated by the 'off' to 'on' transition of the optocoupler. A transition from 'on' to 'off' while the routine is running would stop it.</p> <p>While running, the routine may not be interrupted by another function with higher priority. If 'on' remains established after completion this will not re-initiate the function and does also not block functions with lower priorities.</p> <p> Without a LEARN data set the PID controller is not able to perform pressure control.</p>	4 ²⁾
18	LOCK	Digital input ¹⁾	<p>This function locks the valve in remote operation. In case the valve is in local operation it will turn to remote operation. Local operation via service port is not possible when LOCK is activated.</p> <p>When the signal is released the valve remains in remote operation but local operation may be activated via service port.</p>	N/A
6	DIGITAL GROUND	Digital ground	<p>Ground for all digital inputs. Ground is used when digital inputs are operated by switches. Connect switches to ground.</p> <p>Refer also to «Function and wiring» configuration a).</p>	
4	DIGITAL COMMON	Digital common	<p>Common for all digital inputs. Common is used when digital inputs are driven by voltage sources. Connect + or – terminal of source with common (input optocouplers are capable of bidirectional operation).</p> <p>Refer also to «Function and wiring» configuration b).</p>	

1) All digital inputs are digitally filtered. Filter delay is 50ms. This means that digital signals must be applied for at least 50ms to be effective. Refer to «Function and wiring» for details about input circuit.

2) Highest priority is 1. Functions with lower priorities will not be effective as long as higher priority functions are active.

4.5.8 Digital outputs

Pin	Function	Signal type	Description
8	VALVE OPEN or SERVICE REQUEST	Digital output ¹⁾	<p>This output is active in all operation modes and indicates either that the valve is open or that a service is requested.</p> <p>A service request is indicated when the valve requires cleaning due to contamination.</p> <p>Configuration of the functionality of this output can be done in local operation via service port.</p> <p>By default the output indicates open</p>
9	VALVE CLOSED or SERVICE REQUEST	Digital output ¹⁾	<p>This output is active in all operation modes and indicates either that the valve is close or that a service is requested.</p> <p>A service request is indicated when the valve requires cleaning due to contamination.</p> <p>Configuration of the functionality of this output can be done in local operation via service port.</p> <p>By default the output indicates close</p>
22	VALVE STATUS	Digital output ¹⁾	<p>The meaning of this output depends on the operation mode. e.g.</p> <p><u>LEARN:</u> LEARN is not completed yet.</p> <p><u>PRESSURE CONTROL:</u> Actual pressure is out of $\pm 2\%$ range of SETPOINT</p> <p><u>POSTION CONTROL:</u> Actual position is out of $\pm 0.1\%$ range of SETPOINT</p>
21	READY	Digital output ¹⁾	<p>This signal indicates that the valve is ready for remote operation. If this signal is not active the valve is in one of the following modes:</p> <ul style="list-style-type: none"> • Synchronization during power up • Local operation via service port • Safety mode. Refer to «Safety mode» for details.
20	COMMON	Digital common	Common for all digital outputs.

1) Refer to «Function and wiring» for details about output circuit.

4.5.9 Analog inputs and outputs

Pin	Function	Signal type	Description
25	SETPOINT	Analog input ¹⁾	<p>The meaning of the setpoint input depends on the operation mode.</p> <p><u>LEARN:</u> A voltage of 0-10V shall be applied to this input as pressure limit for learn. The limit pressure is in linear relation to the applied voltage. 10V relates to sensor full scale. In case of 2 sensor operation 10V relates to sensor 1 full scale (high range).</p> <p> To activate pressure limit function for remote operation it must be configured accordingly. Refer to «Interface configuration»</p> <p><u>PRESSURE CONTROL:</u> A voltage of 0-10V shall be applied to this input as pressure setpoint. The pressure setpoint is in linear relation to the applied voltage. Depending on selected SETPOINT RANGE 10V means either sensor full scale or 10% of sensor full scale. In case of 2 sensor operation 10V relates to sensor 1 full scale (high range).</p> <p><u>POSITION CONTROL:</u> A voltage of 0-10V shall be applied to this input as position setpoint. The position setpoint is in linear relation to the applied voltage. 0V is closed but not isolation function and 10V is open position. (Use digital input for isolation function)</p>
12	PRESSURE	Analog output ¹⁾	<p>This output indicates the current pressure as 0-10V. The output voltage is in linear relation to the pressure. Depending on the selected SETPOINT RANGE 10V means either sensor full scale or 10% of sensor full scale. In case of 2 sensor operation sensor full scale relates to sensor 1 (high range).</p>
11	POSITION	Analog output ¹⁾	<p>This output indicates the current valve position as 0-10V voltage range. The voltage is in linear relation to the valve position. 0V is closed but not isolation function and 10V is open position. (Use digital output for isolation function)</p>
13	ANALOG GROUND	Analog ground	Ground for analog input and analog outputs.
1	CHASSIS GROUND	Chassis ground	Chassis ground connected to case. Shall be used to connect cable shield.

1) Refer to «Function and wiring» for details about input / output circuit.

4.6 Initial operation



To enable the valve for **pressure control** setup **steps 1 to 6 must be performed**. In case position control is required only it's sufficient to perform steps 1 to 3.

Setup steps		Description
1	Power up	Turn on external + 24VDC power supply of valve (and external ± 15 VDC for sensor power supply if required). Refer to chapter «Behavior during power up» for details.
2	Interface configuration	Refer to chapter «Interface configuration» for details.
3	Valve configuration	Basic configurations of valve must be adapted according to application needs. Refer to chapter «Valve configuration» for details.
4	Sensor configuration	Basic configurations of sensor(s) must be adapted according to application needs. Refer to chapter «Sensor configuration» for details.
5	ZERO	Compensation of the sensor offset voltage. Refer to chapter «ZERO» for details.
6	LEARN	Determination of the vacuum system characteristic to accommodate the PID controller. Refer to chapter «LEARN» for details.



Without LEARN the valve is not able to run pressure control.

4.6.1 Interface configuration

Interface configuration must be adapted according to application needs.

Default configuration:

OPEN input	CLOSE input	OPEN output	CLOSE output
not inverted	not inverted	open	close

- Functionality of digital inputs CLOSE VALVE and OPEN VALVE must be selected. These may be configured as 'not inverted' or 'inverted'. Default is 'not inverted'.
- LEARN range configuration for remote operation must be selected. This may either be 'full range' or pressure limit according of analog SETPOINT input. Default is 'full range'.

Local operation: (‘Control View’, ‘Control Performance Analyzer’ or ‘Service Box 2’)	Remote operation:
Do configuration in menu ‘Setup / Interface’.	It's not possible to do ‘Interface configuration’ via remote operation.

4.6.2 Valve configuration

Basic valve configuration must be adapted according to application needs.

Definition of valve plate position in case of:

- **After power up**, default is 'close'.
- **Power failure**, default is 'close'. Only for versions that have Power Fail Option equipped [642 C or 642 H].
- **Network failure**, default setting refer to individual product data sheet.

Local operation: (‘Control View’, ‘Control Performance Analyzer’ or ‘Service Box 2’)	Remote operation:
1. Do power up configuration in menu ‘Setup / Valve’.	Note: It’s not possible to do ‘Valve configuration’ via remote operation.
2. Do power fail configuration in menu ‘Setup / Valve’.	

4.6.3 Sensor configuration

Basic sensor configuration must be adapted according to application needs.

- ZERO function: This may be ‘disabled’ or ‘enabled’. Default is ‘enabled’. Refer also to chapter «ZERO».
- Sensor configuration with 1 sensor version [642 C -].

Local operation: (‘Control View’, ‘Control Performance Analyzer’ or ‘Service Box 2’)	Remote operation:
1. Enable or disable ZERO function in menu ‘Setup / Sensor’.	Note: It’s not possible to do ‘Sensor configuration’ via remote operation.
2. Do 1 sensor configuration in menu ‘Setup / Sensor’.	

4.6.4 ZERO

ZERO allows for the compensation of the sensor offset voltage.

When ZERO is performed the current value at the sensor input is equated to pressure zero. In case of a 2 sensor system both sensor inputs will be adjusted. A max. offset voltage of +/-1.4V can be compensated. The offset value can be read via local and remote operation.

Local operation: (‘Control View’, ‘Control Performance Analyzer’ or ‘Service Box 2’)	Remote operation: (Refer to chapter «Digital inputs» for details)
Go to menu ‘Zero / ZERO’ and follow instructions.	1. Send OPEN VALVE
	2. Wait until process chamber is evacuated and sensor signal is not shifting anymore.
	3. Send ZERO



- Do not perform ZERO as long as pressure gauge voltage is shifting otherwise incorrect pressure reading is the result. Refer to manual of sensor manufacturer for warm up time.
- Do not perform ZERO, if the base pressure of your vacuum system is higher than 1‰ of sensor full scale. We recommend disabling ZERO function in this case; refer to «Valve and sensor configuration» of the setup procedure. Otherwise incorrect pressure reading is the result.

4.6.5 LEARN

LEARN adapts the PID controller of the valve to the vacuum system and its operating conditions. LEARN must be executed only once during system setup. The LEARN routine determines the characteristic of the vacuum system. Based on this, the PID controller is able to run fast and accurate pressure control cycles.

This characteristic depends on various parameters such as chamber volume, conductance and flow regime. Therefore it must be performed with a specific gas flow according to instruction below. The result of LEARN is a pressure versus valve position data table. This table is used to adapt the PID parameters. The data table is stored in the device memory which is power fail save. The data table can be up-/downloaded via 'Control Performance Analyzer' software or remote interface. Due to encoding the data may not be interpreted directly. By an OPEN VALVE, CLOSE VALVE, POSITION CONTROL or PRESSURE CONTROL command the routine will be interrupted.

Local operation: (‘Control View’, ‘Control Performance Analyzer’ or ‘Service Box 2’)	Remote operation: (Refer to chapter «Digital inputs» for details)
<p>Go to ‘Learn / LEARN’ menu and follow instructions.</p> <p>Gasflow calculation according to recommendation below is done automatically based on inputs.</p>	1. Send OPEN VALVE
	2. Set specific gas flow according to calculation below and wait until flow is stable. LEARN does not need to be performed with the process gas. Instead N ₂ or Ar may be used.
	3. Set SETPOINT (= pressure limit for learn) to p _{max} (max. pressure to control during process)
	4. Set LEARN Alarm (VALVE STATUS) is set as long learn is performed, if alarm is off, learn is finished.
	5. Reset LEARN
	6. Reset OPEN VALVE



Sensor signal must not shift during LEARN. Wait until sensor signal is stable before LEARN is performed. Learn may take several minutes. Do not interrupt the routine as **a single full run is required to ensure fast and accurate pressure control**. The PID controller covers 5% to 5000% of the gas flow which was used for learn.

Gasflow calculation for LEARN:



Do not apply a different gasflow for learn than determined below. Otherwise pressure control performance may be insufficient.

Required pressure / flow regime must be known to calculate the most suitable learn gas flow for a specific application.

- At first it is necessary to find out about the required control range respectively its conductance values. Each working point (pressure / flow) must be calculated with one following formulas. Choose the applicable formula depending on units you are familiar with.

$$C_{WP} = \frac{1000 \cdot q_{WP}}{p_{WP}}$$

C_{WP} required conductance of working point [l/s]
 q_{WP} **gasflow** of working point [Pa m³/s]
 p_{WP} **pressure** of working point [Pa]

$$C_{WP} = \frac{q_{WP}}{p_{WP}}$$

C_{WP} required conductance of working point [l/s]
 q_{WP} **gasflow** of working point [mbar l/s]
 p_{WP} **pressure** of working point [mbar]

$$C_{WP} = \frac{q_{WP}}{78.7 \cdot p_{WP}}$$

C_{WP} required conductance of working point [l/s]
 q_{WP} **gasflow** of working point [sccm]
 p_{WP} **pressure** of working point [Torr]

- Out of these calculated conductance values choose the lowest.

$$C_R = \min(C_{WP1}, C_{WP2}, \dots, C_{WPn})$$

C_R required lower conductance [l/s]
 C_{WPx} required conductance of working points [l/s]



To make sure that the valve is capable to control the most extreme working point verify that $C_R \geq C_{min}$ of the valve (refer to «Technical data»).

- Calculate gasflow for learn. Choose the applicable formula depending on units you are familiar with.

$$q_L = \frac{p_{SFS} \cdot C_{min}}{1100}$$

q_L gasflow for learn [Pa m³/s]
 p_{SFS} sensor full scale pressure [Pa]
 C_{min} min. controllable conductance of valve [l/s], (refer to «Technical data»)

$$q_L = \frac{p_{SFS} \cdot C_{min}}{1.1}$$

q_L gasflow for learn [mbar l/s]
 p_{SFS} sensor full scale pressure [mbar]
 C_{min} min. controllable conductance of valve [l/s], (refer to «Technical data»)

$$q_L = 71 \cdot p_{SFS} \cdot C_{min}$$

q_L gasflow for learn [sccm]
 p_{SFS} sensor full scale pressure [Torr]
 C_{min} min. controllable conductance of valve [l/s], (refer to «Technical data»)

4.6.6 Tuning of control performance

Normally the default settings will result in good pressure control performance. For some applications tuning may be required to improve performance. The tuning procedures for each parameter (grey boxes) and its default values are described separately below. Strictly keep the procedure order.

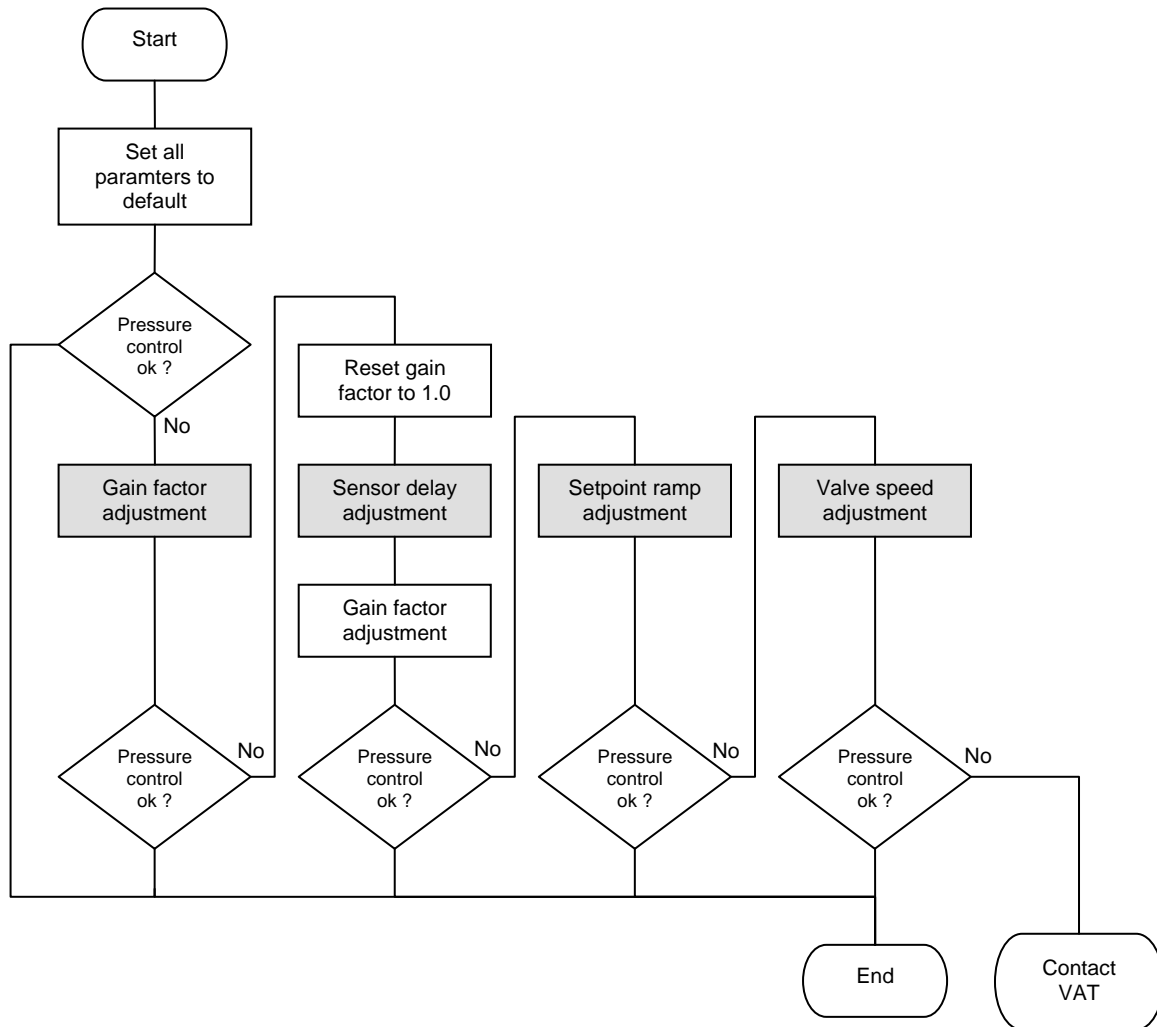

Required information for support:

- Go to 'Tools / Create Diagnostic File' in 'Control View' resp. 'Control Performance Analyzer' and save file
- Pressure / flow / gas conditions to be controlled
- Chamber volume
- Pumping speed (l/s) and pump type (e.g. turbo pump)
- System description
- Problem description

Send diagnostic file with and all required information to tuning-support@vat.ch

4.6.6.1 Gain factor adjustment

The gain factor effects: **Stability, Response time**

Default value is 1. Adjustment range is from 0.0001 to 7.5.

Higher gain results in:	faster response	higher over- / undershoot of pressure
Lower gain results in:	slower response	lower over- / undershoot of pressure

Adjustment procedure:

1. Start with gain factor 1.0
2. Open valve.
3. Control a typical pressure / flow situation.
4. Repeat from step 2 with lower (higher) gain factors until optimal pressure response is achieved and stability is ok.



Normally adjustments down to gain factors of 0.42 should lead to good results. Otherwise you may need to improve sensor connection. Refer to «Requirements to sensor connection».

Local operation: (‘Control View’, ‘Control Performance Analyzer’ or ‘Service Box 2’)	Remote operation:
Set gain factor in menu ‘Setup / Control Parameter’	It’s not possible to do ‘Gain factor adjustment’ via remote operation.

4.6.6.2 Sensor delay adjustment

Sensor delay adjustment effects: **Stability**

Default value is 0sensorDeay0. Adjustment range is from 0 to 1.0s.

Pipes and orifices for sensor attachment delay response time and so badly impact pressure control stability.

By adapting this parameter to the approximate delay time stability problems can be reduced. But control response time will be slowed down by this measure.



Whenever possible sensors should be attached to the chamber according to «Requirements to sensor connection». This is the most effective measure against stability issues. If your gauge attachment fulfills these criteria do not use this parameter.

Adjustment procedure:

1. Start with gain factor 1.0 and sensor delay 0s.
2. Open valve.
3. Control a typical pressure / flow situation.
4. Repeat from step 2 with higher sensor delays until best possible stability is achieved.
5. Adjustment gain factor again. Refer to «Gain factor adjustment».

<p>Local operation: (‘Control View’, ‘Control Performance Analyzer’ or ‘Service Box 2’)</p>	<p>Remote operation:</p>
<p>Go to ‘Setup / Control Parameter’ menu. Select sensor delay.</p>	<p>It’s not possible to do ‘Sensor delay adjustment’ via remote operation.</p>

4.6.6.3 Setpoint ramp adjustment

Setpoint ramp effects: **Undershoot of pressure, Response time**

Default value for Setpoint Ramp is 0. Adjustment range for Setpoint Ramp is from 0 to 10 s.

This parameter defines the time that is used to decrease / raise pressure between 2 setpoints. Especially in pressure decrease situations at low flows pressure response can be improved much by adapting setpoint ramp time.

Pressure chart

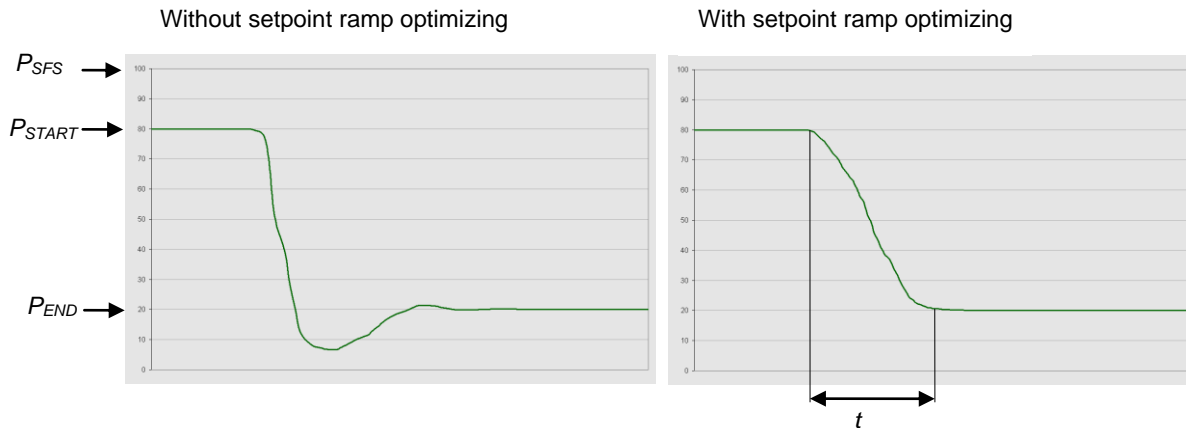

Choose the applicable formula depending on units you are familiar with.

$$t = \frac{S_{RAMP}}{P_{SF5}} \bullet |P_{START} - P_{END}|$$

t	ramptime [s]
P _{SF5}	sensor full scale pressure
S _{RAMP}	setpoint ramp [s]
P _{START}	pressure start
P _{END}	pressure end

Adjustment procedure:

1. Start with optimal gain factor and sensor delay time according to preceding tuning steps.
2. Control a typical pressure / flow situation.
3. Control a lower pressure.
4. Repeat from step 2 with longer setpoint ramps until best response is achieved.
5. Verify pressure control response for a setpoint raise situation.



In case a long ramp time is required to get optimal performance for pressure decrease situations it may be of advantage to apply different settings for decrease / raise control situations.

<p>Local operation: (‘Control View’, ‘Control Performance Analyzer’ or ‘Service Box 2’)</p>	<p>Remote operation:</p>
<p>Go to ‘Setup / Control Parameter’ menu. Select setpoint ramp.</p>	<p>It’s not possible to do ‘Setpoint ramp adjustment’ via remote operation.</p>

4.6.6.4 Valve speed adjustment

Valve speed effects: **Response time**

Default value is 1000. Adjustment range is from 1 to 1000.

This parameter effects valve plate actuating speed.
Speed adjustment is effective for PRESSURE CONTROL and POSITION CONTROL.





Normally best pressure control response is achieved with max. valve speed. In particular applications it may be of advantage to have a slower valve response. OPEN and CLOSE are always done with maximum speed.

Adjustment procedure:

1. Use optimal gain factor, sensor delay time and setpoint ramp according to preceding tuning steps.
2. Open valve.
3. Control a typical pressure / flow situation.
4. Repeat from step 2 with slower valve speed until required response is achieved.

<p>Local operation: (‘Control View’, ‘Control Performance Analyzer’ or ‘Service Box 2’)</p>	<p>Remote operation:</p>
<p>Go to ‘Setup / Control Parameter’ menu. Select valve speed.</p>	<p>It’s not possible to do ‘Valve speed adjustment’ via remote operation.</p>

5 Operation

	<p style="text-align: center;">⚠ WARNING</p> <p>Unqualified personnel Inappropriate handling may cause serious injury or property damage. Only qualified personnel are allowed to carry out the described work.</p>
	<p style="text-align: center;">⚠ WARNING</p> <p>Valve opening Risk of serious injury. Human body parts must be kept out of the valve opening and away from moving parts. Do not connect the controller to power before the valve is installed complete into the system.</p>

5.1 Normal operation

This valve is designed for downstream pressure control in vacuum chambers. It can be employed in a pressure control mode or a position control mode. In both cases local or remote operation is possible.

5.1.1 Local operation

Local operation means that the valve is operated via the service port using a computer or the Service Box 2. When using a computer, a service cable and a software from VAT is required. You can use our Software (freeware) 'Control Performance Analyzer' which can be downloaded from: <http://www.vatvalve.com/customer-service/informations-and-downloads/control-performance-analyzer>.

These softwares are beneficial especially for setup, testing and maintenance.

How to start:

Connect service cable between PC and valve controller, start software and push button 'LOCAL' to enable for operation. Then enter menu Sensor / Setup and do sensor configuration according to your application to make sure that you get the correct pressure displayed.

'Control Performance Analyzer' supports:

- Valve setup
- Sensor setup
- Pressure control
- Interface setup
- Manual control
- Sequence control
- Numeric and graphical monitoring
- Data recording
- Data analysis
- Advanced diagnostic

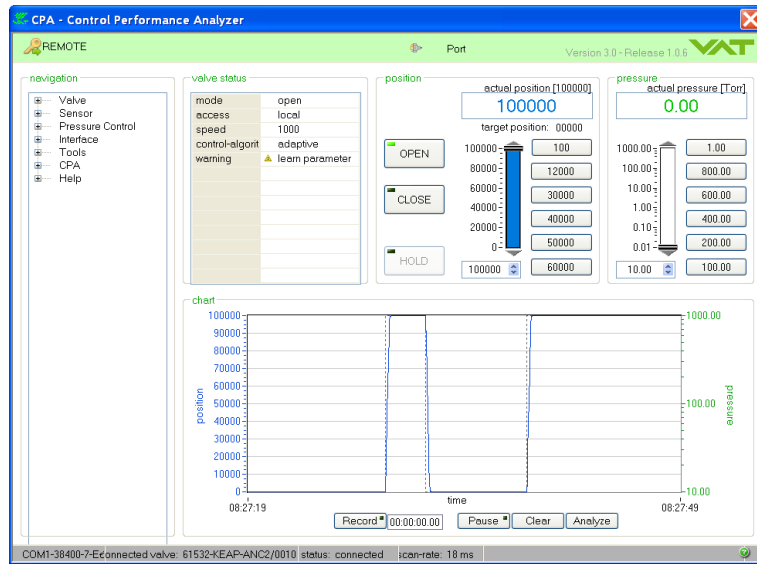

When communication to service port is interrupted the valve will change to remote operation. So when service cable will be disconnected or software will be shut down, the valve returns automatically to remote operation. This may result in an immediate movement of the valve depending on remote control.

Refer to «Accessories» for ordering numbers of service cable and Service Box 2.

5.1.2 Remote operation

This product is equipped with a Logic interface to allow for remote operation. See section «Logic interface» for details. 'Control Performance Analyzer' software or 'Service Box 2' may be used for monitoring during remote control.

'Control Performance Analyzer' software

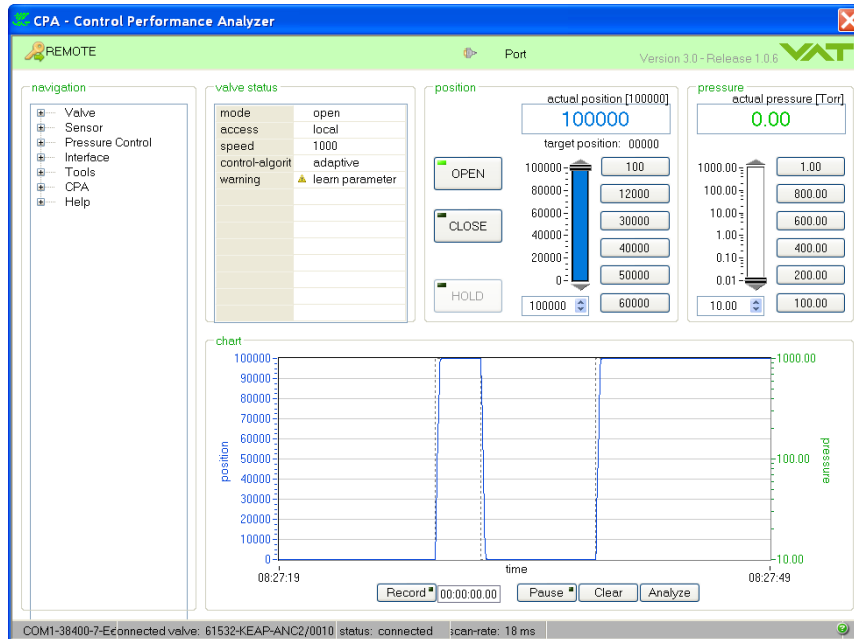

'Service Box 2'



In case 'Control Performance Analyzer' software is connected to valve make sure 'REMOTE' button is pushed to enable for remote operation. In case Service Box 2 is connected to valve make sure the LED on button 'LOCAL' is OFF for remote operation.

5.2 Close valve

Local operation: (‘Control View’, ‘Control Performance Analyzer’ or ‘Service Box 2’)	Remote operation: (Refer to chapter «Digital inputs» for details)
Push CLOSE button	Send CLOSE VALVE

5.3 Open valve

Local operation: (‘Control View’, ‘Control Performance Analyzer’ or ‘Service Box 2’)	Remote operation: (Refer to chapter «Digital inputs» for details)
Push OPEN button	Send OPEN VALVE

5.4 Position control

The valve position is directly controlled according to the position setpoint.

Local operation: (‘Control View’, ‘Control Performance Analyzer’ or ‘Service Box 2’)	Remote operation: (Refer to chapter «Digital inputs» and «Analog inputs and outputs» for details)
Select or enter position setpoint	1. Set CONTROL MODE to POSITION CONTROL
	2. Set position SETPOINT



In case CLOSE VALVE, OPEN VALVE or HOLD is also set these have higher priority.

5.5 Pressure control



To prepare valve for PRESSURE CONTROL perform complete «Setup procedure». The valve has parameters that may be modified to tune pressure control performance. Refer to «Tuning of control performance».

The included PID controller controls the chamber pressure according to the pressure setpoint by means of the valve position. The PID controller works with an adaptive algorithm to achieve best results under altering conditions (gasflow, gas type).

Local operation: (‘Control View’, ‘Control Performance Analyzer’ or ‘Service Box 2’)	Remote operation: (Refer to chapter «Digital inputs» and «Analog inputs and outputs» for details)
Select or enter pressure setpoint	1. Set CONTROL MODE to PRESSURE CONTROL
	2. Set pressure SETPOINT



In case CLOSE VALVE, OPEN VALVE or HOLD is also set these have higher priority.

5.6 Display information

There is a 4 digit display located on the panel. It displays configuration, status and position information. For details see following tables.

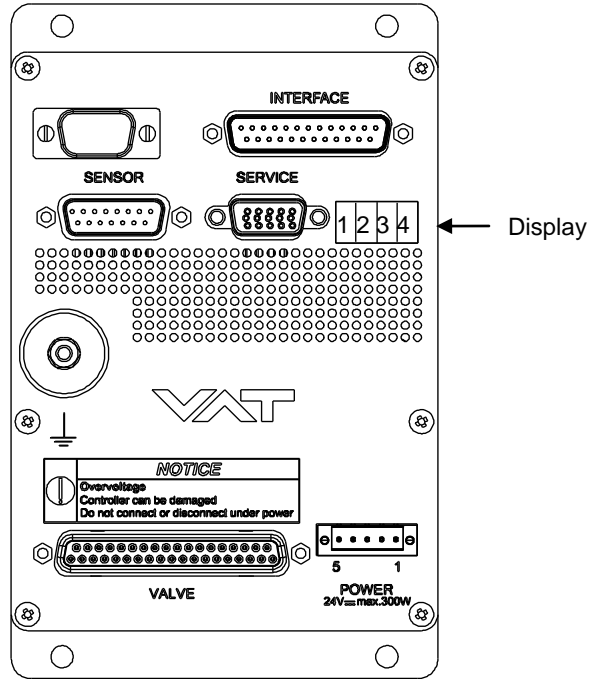

5.6.1 Power up

Description	Digit 1	Digit 2	Digit 3	Digit 4
At first all dots are illuminated then configuration is displayed:	1	E	0	0
- Firmware version [e.g. 1E00] (1st information for about 2s)			0 = basic	
- Controller configuration (2nd information for about 2s)		1 = Logic interface	1 = with SPS ¹⁾	1 = 1 sensor version
SYNC indicates that power up synchronization is running.			2 = with PFO ²⁾	2 = 2 sensor version
In case D C or D999 is displayed, motor interlock is active. Refer to «Safety mode» for details.			3 = with SPS ¹⁾ and PFO ²⁾	
If valve is closed (isolated) display shows alternately C C and INIT . Synchronization will be done when first movement command is received.	S	Y	N	C

1) SPS = optional ±15 VDC Sensor Power Supply module

2) PFO = Power Failure Option

5.6.2 Operation

Description / Mode	Digit 1	Digit 2	Digit 3	Digit 4
PRESSURE CONTROL mode	P	0 . . . 100 = valve position (% , 0 = closed / 100 = open)		
POSITION CONTROL mode	V			
Valve closed	C			
Valve open	O			
HOLD (position frozen) activated	H			
ZERO running	Z			
LEARN running	L			
Safety mode established. Refer to «Safety mode» for details.	D			
Service request ¹⁾			S	R
Power failure	F			

1) SR is blinking alternatively with the actual mode display (e.g. C ↔ SR)

5.6.3 Errors

Description	Digit 1	Digit 2	Digit 3	Digit 4
Fatal error occurred	E	Error code. Refer to «Trouble shooting» for details		

5.6.4 Safety mode

By means of an external switch (see connection diagrams «Electrical connection») the motor power supply can be interrupted. In this case the valve enters the 'safety mode'. This motor interlock prevents the valve from moving (e.g. maintenance work). Data reading from the control unit remains possible. When motor interlock is active during power up the valve directly enters the 'safety mode' and is not able to synchronize. Display shows 'D C' or 'D999'. In this case synchronization cycle will be done when motor interlock is deactivated. Then Display shows 'INIT' for a moment followed by 'SYNC'. When 'safety mode' is entered from operation (i.e. pressure control mode), the unit will automatically switch to position control mode and remain at current position. Once motor interlock is deactivated the unit remains in position control mode.

5.6.5 Service indication

This product is able to indicate that the valve unit needs to be cleaned, or an obstruction is present. A service request is indicated when the control unit detects that motor steps are apparently not effective. This may happen when the valve unit is heavily contaminated. These 'lost' steps are recognized and will be repeated to attempt target position in the short term. But in the medium term the valve unit requires cleaning or inspection. 'Service request' (SR) would be indicated on the display or could be read via remote operation. Refer to «Display information» for details.

5.7 Operation during power up

Valve position before power up:	Reaction of valve:	
	Valve power up configuration = closed (default)	Valve power up configuration = open
Closed (isolated)	Valve remains closed. Display shows alternately 'C C' and 'INIT'. Synchronization will be done when first movement command is received.	Valve runs to max. throttle position to detect the limit stops to synchronize. Display shows configuration of product resp. 'SYNC' until synchronization is done. Valve position after power up is open.
All other than closed (not isolated)	Valve runs to max. throttle position to detect limit stop for synchronization. Display shows configuration of product resp. 'SYNC' until synchronization is done.	
	Valve position after power up is closed	Valve position after power up is open

Refer also to chapter: «Display information».

5.8 Behavior in case of power failure

Valve position before power failure:	Reaction of valve:
Any	Valve will close or open depending on valve configuration. Default is close. Provide that battery pack of the VAT controller is charged. Display indicates F .





All parameters are stored in a power fail save memory.

Technical data of Power Failure Option (PFO):

Charging time	2 minutes max.
Durability	up to 10 years @ 25°C ambient Refer to chapter: «Option board» for more details

5.9 Operation under increased temperature

 CAUTION	
	<p>Hot valve</p> <p>Heated valve may result in minor or moderate injury.</p> <p>Do not touch valve and heating device during operation. Once heating is switched off (valve and system) await until the valve is cooled down complete before doing any work.</p>



This valve may be operated in the temperature range mentioned in chapter «Technical data».

6 Trouble shooting

Failure	Check	Action
No dots lighted on display	- 24 V power supply ok?	- Connect valve to power supply according to «Electrical connection» and make sure that power supply is working.
Remote operation does not work	- Local operation via service port active - Safety mode active, check for D on display?	- Switch to remote operation. - Provide power to motor to allow for operation. - Refer to «Electrical connection» for details.
Display shows «E 20» (fatal error - limit stop of valve unit not detected)	- Clamp coupling screw not fastened?	- Tighten screw. Refer to chapter «Maintenance» for details.
Display shows «E 21» (fatal error - rotation angle of valve plate limited during power up)	- Valve plate centric adjusted? - Valve unit heavy contaminated? - Valve plate mechanically obstructed?	- Adjust valve plate according to «Maintenance procedure». - Clean valve unit according to «Maintenance procedure». - Resolve obstruction. - Reset control unit. Cycle power (OFF→ON) or - Send reset command: local via service port with CV/CPA/Service Box2
Display shows «E 22» (fatal error - rotation angle of valve plate limited during operation)	- Valve unit heavy contaminated? - Valve plate mechanically obstructed?	- Clean valve unit according to «Maintenance procedure». - Resolve obstruction - Reset control unit. Cycle power (OFF→ON) or - Send reset command: local via service port with CV/CPA/Service Box2
Display shows «E 40» (fatal error - motor driver failure detected)		- Replace control and actuating unit according to «Maintenance procedure».
Display shows «D 0» Motor Interlock is open	- Motor power supplied?	- Provide power to motor to allow for operation. - Refer to «Electrical connection» for details.
Display shows «SR» (Service Request)	- Valve unit heavy contaminated?	- Clean valve unit according to «Maintenance procedures». - Reset control unit. Cycle power (OFF→ON) or - Send reset command: local via service port with CV/CPA/Service Box2
Display shows «M C» Maintenance mode active		- Pin 14 of service connector is connected to ground. Plate will close. Further movement of plate is blocked. ¹⁾
Display shows «M100» Maintenance mode active		- Pin 13 of service connector is connected to ground. Plate will open. Further movement of plate is blocked. ¹⁾
POSITION CONTROL does not work	- Safety mode active, check for D on display?	- Provide power to motor to allow for operation. - Refer to «Electrical connection» for details.
	- POSITION CONTROL selected, check for V on display?	- Select POSITION CONTROL mode. Refer to «Position control» for details.

¹⁾ Priority of pin 14 is higher than pin 13. If pin 14 is connected to ground after pin 13 the valve will close. Ground of service connector is at pin 4 and 8.

Failure	Check	Action
Pressure reading is wrong or pressure reading is negative	<ul style="list-style-type: none"> - Sensor(s) connected? - 2 sensor version present at valve controller? - ZERO done? - Does sensor power supply provide enough power for sensor(s)? 	<ul style="list-style-type: none"> - Refer to «Electrical connection». - Check valve version on page 1. Verify configuration. Refer to «Setup procedure». - Perform ZERO when base pressure is reached. Refer to «ZERO» for details. - Verify sensor supply voltage.
CLOSE VALVE does not work	<ul style="list-style-type: none"> - Safety mode active, check for D on display? - Maintenance mode active 	<ul style="list-style-type: none"> - Provide power to motor to allow for operation. - Refer to «Electrical connection» for details. - Refer to "Display shows «M C»" in this table
OPEN VALVE does not work	<ul style="list-style-type: none"> - Safety mode active, check for D on display? - Maintenance mode active 	<ul style="list-style-type: none"> - Provide power to motor to allow for operation. - Refer to «Electrical connection» for details. - Refer to "Display shows «M100»" in this table
ZERO does not work	<ul style="list-style-type: none"> - Valve in open position, check for O on display? - ZERO disabled? 	<ul style="list-style-type: none"> - OPEN VALVE and bring chamber to base pressure before performing ZERO. - Enable ZERO. Refer to «Valve configuration» for details.
Pressure is not '0' after ZERO PRESSURE CONTROL does not work	<ul style="list-style-type: none"> - Sensor voltage shifting? - System pumped to base pressure? - Sensor offset voltage exceeds $\pm 1.4V$ - Safety mode active, check for D on display? - PRESSURE CONTROL selected, check for P on display? - LEARN done? 	<ul style="list-style-type: none"> - Wait until sensor does not shift any more before performing ZERO. - OPEN VALVE and bring chamber to base pressure before performing ZERO. - Replace pressure gauge. - Provide power to motor to allow for operation. Refer to «Electrical connection» for details. - Select PRESSURE CONTROL mode. Refer to «Pressure control» for details. - Perform LEARN. Refer to «Setup procedure» for details.
PRESSURE CONTROL not optimal	<ul style="list-style-type: none"> - Setup done completely? - LEARN done? - ZERO performed before LEARN? - LEARN interrupted? - Was gas flow stable during LEARN? - Tuning done? - Is sensor range suited for application? - Noise on sensor signal? 	<ul style="list-style-type: none"> - Perform «Setup procedure» completely. - Perform LEARN. Refer to «LEARN» for details. - Perform ZERO then repeat LEARN. Refer to «Setup procedure» for details. - Repeat LEARN. Refer to «LEARN» for details. - Repeat LEARN with stable gas flow. Refer to «LEARN» for details. - Tune valve for application. Refer to «Tuning of control performance» for details. - Use a sensor with suitable range (controlled pressure should be >3% and < 98% of sensor full scale). - Make sure a shielded sensor cable is used.



If you need any further information, please contact one of our service centers. You will find the addresses on our website: www.vatvalve.com.

7 Maintenance

	<p style="text-align: center;">! WARNING</p> <p>Unqualified personnel Inappropriate handling may cause serious injury or property damage. Only qualified personnel are allowed to carry out the described work.</p>
	<p style="text-align: center;">! WARNING</p> <p>Valve opening Risk of serious injury. Human body parts must be kept out of the valve opening and away from moving parts. Disconnect power on controller before doing any work.</p>
	<p style="text-align: center;">! CAUTION</p> <p>Hot valve Heated valve may result in minor or moderate injury. Do not touch valve and heating device during operation. Once heating is switched off (valve and system) await until the valve is cooled down complete before doing any work.</p>
	<p style="text-align: center;">NOTICE</p> <p>Contamination Gate and other parts of the valve must be protected from contamination. Always wear clean room gloves when handling the valve.</p>

7.1 Maintenance intervals

Under clean operating conditions, the valve does not require any maintenance during the specified cycle life. Contamination from the process may influence the function and requires more frequent maintenance.

Before carrying out any maintenance, please contact VAT. It has to be individually decided whether the maintenance can be performed by the customer or has to be carried out by VAT. Please write down the fabrication number of the valve before contact VAT. Refer to chapter «Identification of product» for fabrication number.

7.2 Maintenance procedures

One maintenance procedures are defined for this valve:

- **Replacement of gate seal (gate and bonnet seal) and valve cleaning**



Required frequency of cleaning and replacement of seals is depending on process conditions.

VAT can give the following recommendations for preventive maintenance:

Replacement of	Recommendation
Gate seal (gate and bonnet seal)	Every 100'000 cycles







For spare parts of gate and bonnet seal refer to chapter: «Spare parts»



7.2.1 Replacement of gate seals and valve cleaning

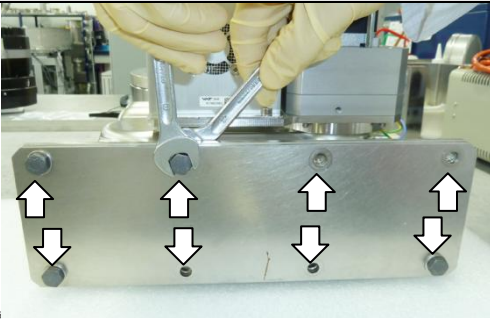

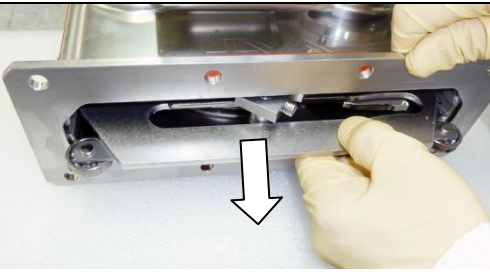

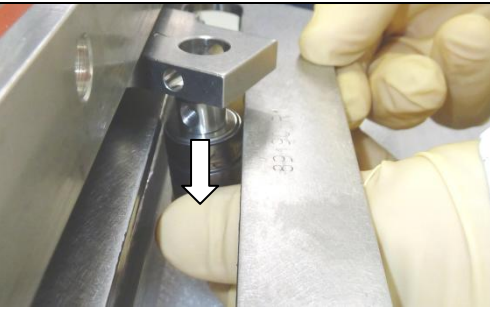
7.2.1.1 Required tools

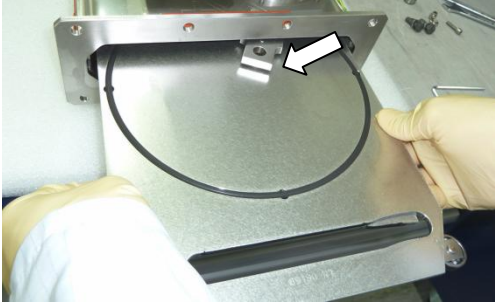

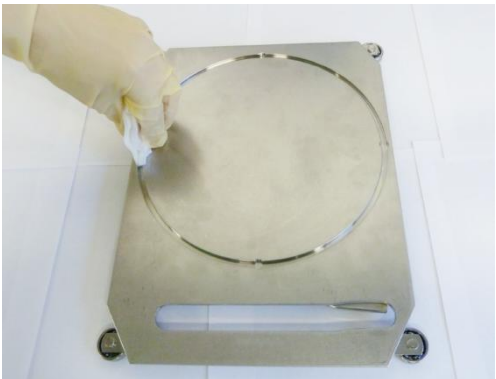
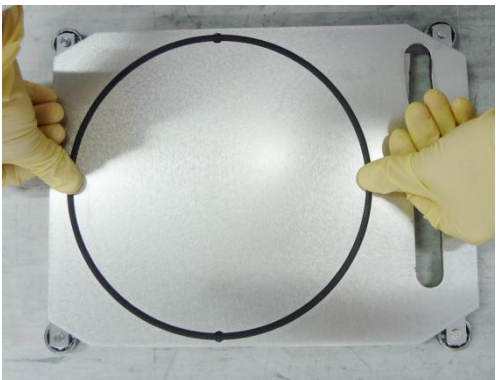

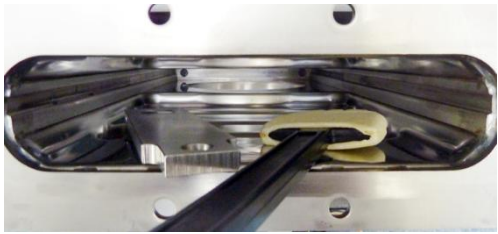
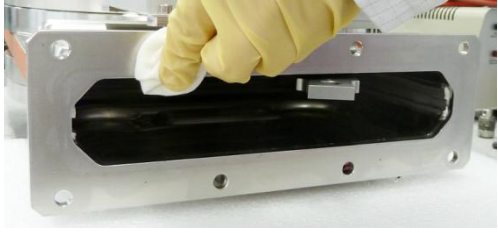
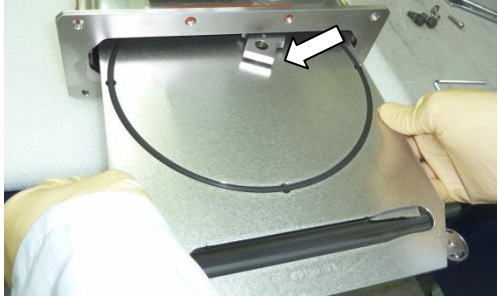
- Allen Wrench 4 mm (Allen torque wrench 4 mm)
- Isopropyl alcohol
- 2 x Open end wrench 13mm
- Vacuum grease (see chapter spare parts)
- Open end torque wrench 13 mm
- O-ring removal tool (see chapter Accessories)
- Clean room wiper

Description	Required tool
<ol style="list-style-type: none"> 1. Vent both valve chambers 2. Open the valve 3. Turn off power to valve controller 4. Disable power-fail option (wait 60 seconds) 	CPA or Service Box 2
<ol style="list-style-type: none"> 5. Disconnect power cable at controller 	

Description	Required tool	
<p>6. Unfasten and remove the bonnet screws</p>		<p>2 x Open end wrench 13 mm</p>
<p>7. Remove valve bonnet and vulcanized bonnet seal 8. Deposit both parts on a clean place</p>		
<p>9. Pull out the gate until the crank bolt can be reached</p>		
<p>10. Loosen and remove the crank bolt screw</p>		<p>Allen wrench 4 mm</p>
<p>11. Remove the crank bolt from lever</p>		

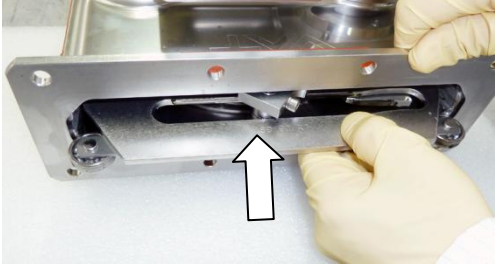
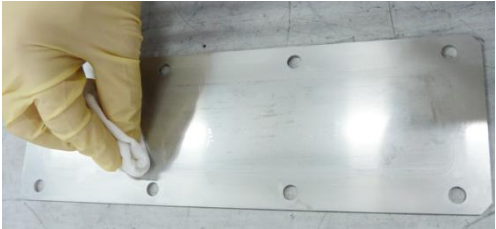
Description	Required tool
<p>12. Pull out the gate assembly complete</p> <p>Caution! Take care that gate is not scratching at lever while pulling out</p>	
<p>13. Place the gate on a clean place</p> <p>14. Remove the gate o-ring</p>	
<p>15. Clean the o-ring groove and the gate assembly</p>	
<p>16. Install the new o-ring equally in o-ring groove (for new o-ring refer to chapter: «Spare parts»)</p>	

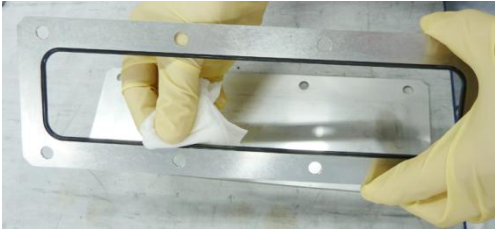
Description	Required tool	
17. Clean the valve body inside		Cleaning tool a little soaked with isopropyl alcohol (refer to chapter «Spare parts» for cleaning tool)
18. Clean the sealing surface of valve		Clean room wiper a little soaked with isopropyl alcohol
19. Push in the gate assembly until...see step 20 Caution! Take care that gate is not scratching at lever while pushing in.		
20. Insert the crank bolt at lever  If necessary use a new crank bolt (for new crank bolt refer to chapter: «Spare parts»).		
21. Fasten the crank bolt screw with 5.7 Nm		Allen torque wrench 4 mm

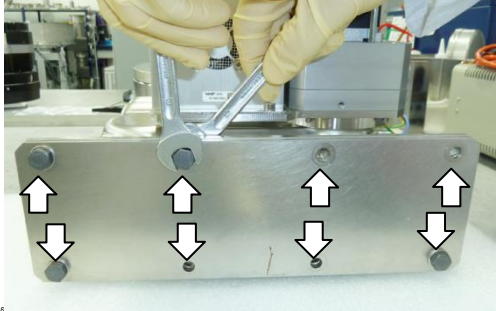
Description	Required tool	
22. Push in the gate assembly into valve body		
23. Clean the valve bonnet		Clean room wiper a little soaked with isopropyl alcohol
24. Clean the bonnet seal 25. Lubricate the seal side with 0.1 ml vacuum grease  If necessary use a new bonnet seal (for new bonnet seal refer to chapter: «Spare parts») If new bonnet seal is used, no cleaning and lubrication is needed.		Clean room wiper Vacuum grease
26. Reassemble the bonnet and bonnet seal with valve		
27. Fasten the bonnet screws with 18 Nm		1 x Open end torque wrench 13 mm 1 x Open end wrench 13 mm

7.2.2 Replacement of Option board

	NOTICE
	<p>Electrostatic discharge Electronic components could be damage. All work on the control and actuating unit has to be done under ESD protected environment to prevent electronic components from damage.</p>

	NOTICE
	<p>Burned connector pins (spark) Connector pins or electronic parts could damage, if plugged and unplugged under power. Do not plug or unplug connectors under power.</p>

The option board may or may not be equipped in your valve depending on the order. Refer to page 1 of this manual to check valve version. This board includes the optional modules for the valve which are:

- ± 15 VDC sensor power supply (SPS)
- Power failure option (PFO)

It is available in 3 versions. These are:

- SPS module only
- PFO module only
- SPS and PFO module

The modules may be retrofitted or replaced easily. The battery lifetime of the PFO module depends on the ambient temperature (see below). To assure PFO function the option board must be replaced after battery life has expired. For ordering number of the modules refer to chapter «Spare parts».

7.2.2.1 Durability of power fail battery

The curves in the graph show the estimated life of Ultra Cap PFO in the worst condition (max. sensor load = 1 A, valve heating temperature = 150 °C).

If the SPS is not fully loaded (< 1 A) or heating temperature of valve body is lower than 150 °C, the corresponding life time curve will be somewhere in between the upper and the lower curve.

Therefore please determine the equivalent maintenance period for replacing the Ultra Cap battery (Option board).

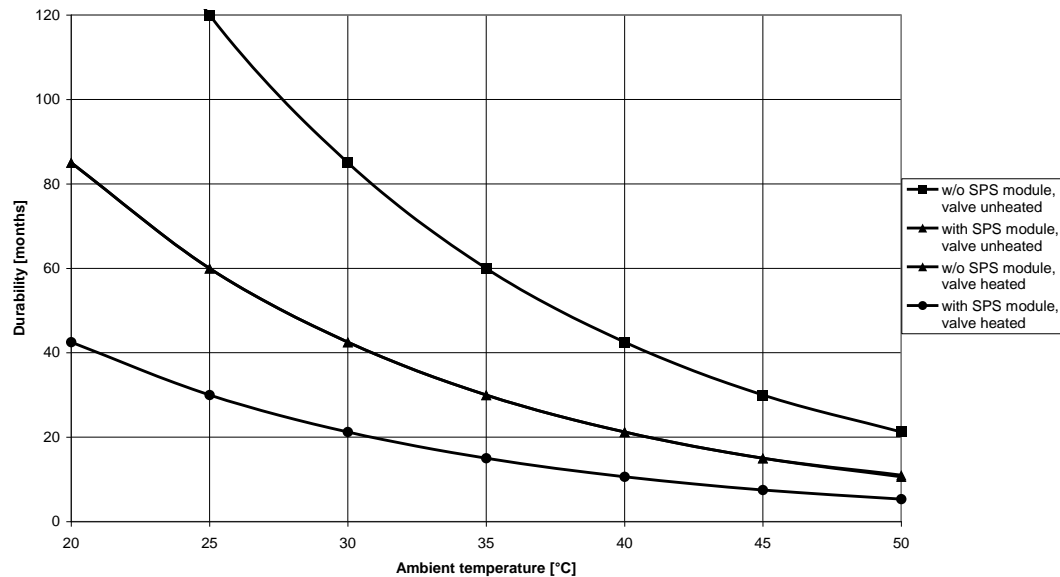

This graph shows estimated life of Ultra Cap PFO for reference and not as guaranteed value.

7.2.3 Retrofit / replacement procedure

Top view on control and actuating unit with panel removed:

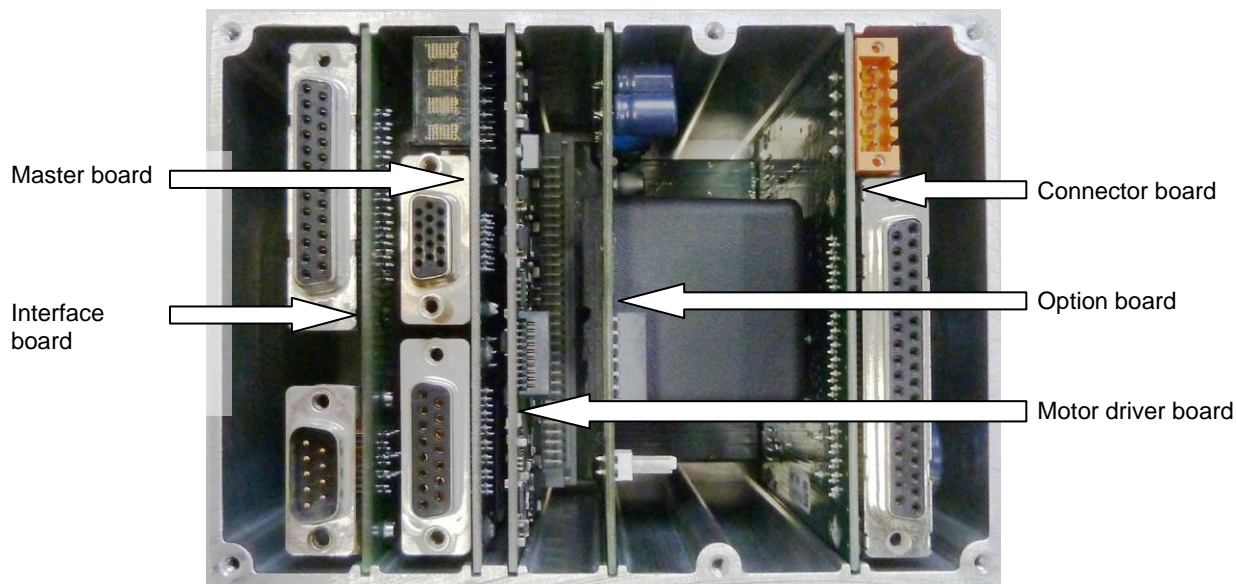



All boards have a fixed position into control and actuating unit. It is not possible to fit a board in other position as shown in picture above!

7.2.3.1 Needed tools

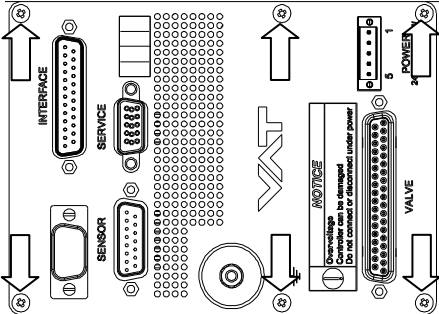
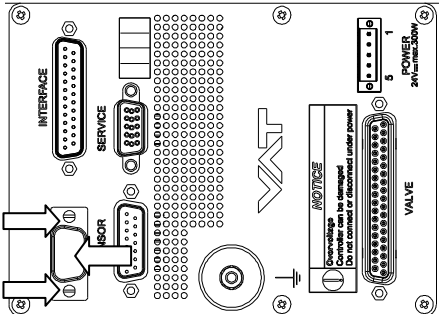
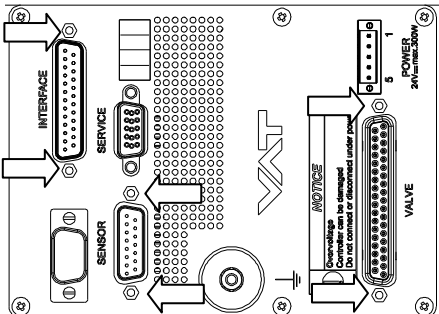

- Open end wrench 4.5 mm
- Pozidriv screw driver size 1

Description		Required tool
<p>1. Disconnect all electrical connections at controller.</p>	<p>Attention to ESD protection!</p> 	<p>Pozidriv screw driver size1 Open end wrench 7 mm</p>
<p>2. Remove the panel screws.</p>		<p>Pozidriv screw driver size1</p>
<p>3. Remove this screws and the cover.</p>		<p>Screw driver size 2</p>
<p>4. Remove female screw locks from connectors.</p>		<p>Open end wrench 4.5 mm</p>
<p>5. Lift controller panel carefully.</p>		<p>(sample picture)</p>

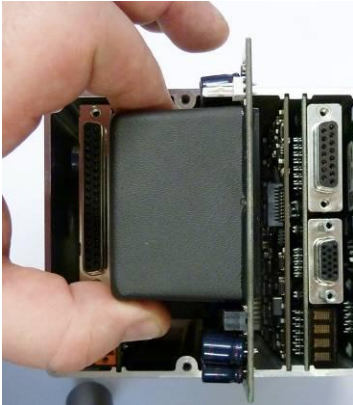
Description		Required tool
6. Remove or replace option board.		(sample picture)
7. Reassemble all parts in reverse order (see steps 6...3). 8. Tighten panel screws with 1.1 Nm (see step 3).		
9. Connect all electrical connections.		Pozidriv screw driver size1 Open end wrench 7 mm



If you need any further information, please contact one of our service centers. You can find the addresses on our website: www.vatvalve.com.

8 Repairs

Repairs may only be carried out by the VAT service staff. In exceptional cases, the customer is allowed to carry out the repairs, but only with the prior consent of VAT.

Please contact one of our service centers. You will find the addresses on our website www.vatvalve.com.

9 Dismounting and Storage

	⚠ WARNING
	Unqualified personnel Inappropriate handling may cause serious injury or property damage. Only qualified personnel are allowed to carry out the described work.

9.1 Dismounting

	NOTICE
	Contamination Gate and other parts of the valve must be protected from contamination. Always wear clean room gloves when handling the valve.

	NOTICE
	Valve in open position Valve body may become damaged if valve gate is in open position. Move valve gate to the closed position before dismounting the valve.

1. Close the valve
2. For dismounting the valve please follow the instructions of chapter: «Installation», however in reverse order.



9.2 Storage



NOTICE	
	<p>Wrong storage</p> <p>Inappropriate temperatures and humidity may cause damage to the product.</p> <p>Valve must be stored at:</p> <ul style="list-style-type: none">– relative humidity between 10% and 70%– temperature between +10 °C and +50 °C– non-condensing environment

NOTICE	
	<p>Inappropriate packaging</p> <p>Product may get damaged if inappropriate packaging material is used.</p> <p>Always use the original packaging material and handle product with care.</p>

1. Clean / decontaminate valve.
2. Cover all valve openings with a protective foil.
3. Pack valve appropriately, by using the original packaging material.

10 Packaging and Transport

	 WARNING
	<p>Unqualified personnel</p> <p>Inappropriate handling may cause serious injury or property damage. Only qualified personnel are allowed to carry out the described work.</p>

	 WARNING
	<p>Harmful substances</p> <p>Risk of injury in case of contact with harmful substances. Remove harmful substances (e. g. toxic, caustic or microbiological ones) from valve before you return the valve to VAT.</p>

	NOTICE
	<p>Inappropriate packaging</p> <p>Product may get damaged if inappropriate packaging material is used. Always use the original packaging material and handle product with care.</p>



- When returning products to VAT, please fill out the VAT form «Declaration of Chemical Contamination of Vacuum Valves and Components» and send it to VAT in advance. The form can be downloaded from our website www.vatvalve.com (Section: Services – Aftersales).
- If products are radioactively contaminated, the VAT form «Contamination and Radiation Report» must be filled out. Please contact VAT in advance.
- If products are sent to VAT in contaminated condition, VAT will carry out the decontaminating procedure at the customer's expense.

10.1 Packaging

	NOTICE
	<p>Valve in open position</p> <p>Valve mechanism may get damaged if valve is in open position. Make sure that the valve is closed.</p>

1. Cover all valve openings with a protective foil.
2. Pack valve appropriately, by using the original packaging material.



VAT disclaims any liability for damages resulting from inappropriate packaging.

10.2 Transport



NOTICE

Inappropriate packaging

Product may get damaged if inappropriate packaging material is used.
Always use the original packaging material and handle product with care.



VAT disclaims any liability for damages resulting from inappropriate packaging.

11 Disposal



WARNING

Unqualified personnel

Inappropriate handling may cause serious injury or property damage.

Only qualified personnel are allowed to carry out the described work.

12 Spare parts



NOTICE

Non-original spare parts

Non-original spare parts may cause damage to the product.
Use original spare parts from VAT only.



- Please specify the fabrication number of the product when you place an order for spare parts; see chapter: «Identification of product». This is to ensure that the appropriate spare parts are supplied.
- VAT makes a difference between spare parts that may be replaced by the customer and those that need to be replaced by the VAT service staff.
- The following table(s) contain spare parts that may be replaced by the customer. If you need any other spare parts, please contact one of our service centers. You will find the addresses on our website www.vatvalve.com.

12.1 Drawing

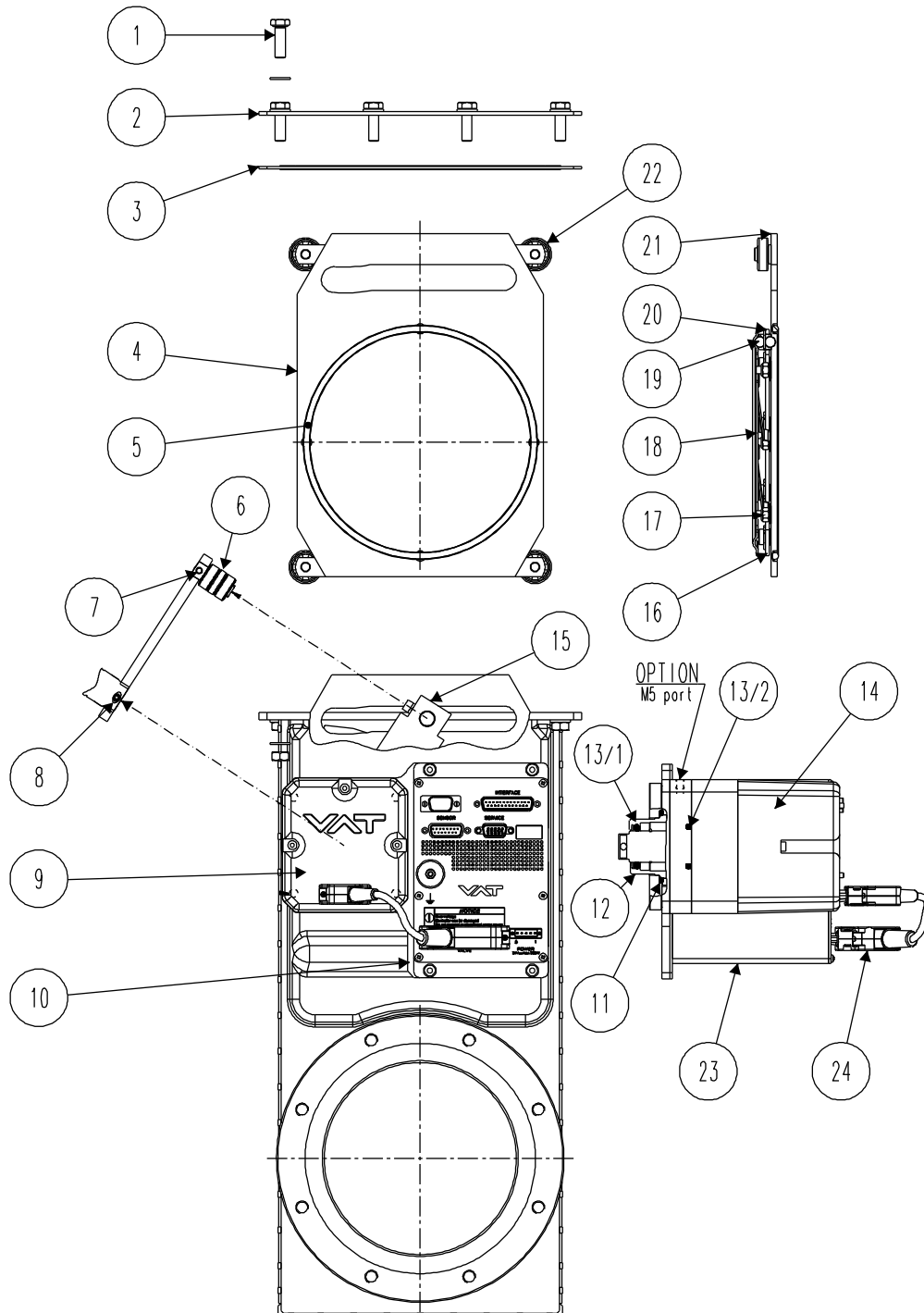



All "Item" refer to chapter «Drawing»

12.1.1 Valve unit with seals and grease

Item	Description	Part number
3	Bonnet seal	77784-R1
4	Gate assembly	84608-R1
5	Gate O-ring	N-5100-372
6	Crank bolt	79090-R1
7	Crank bolt mounting screw with spring washer	N-6005-458 N-6162-405
8	Feedthrough connection pin	N-6097-480
9	Actuator	478357
11	Actuator seal	N-5100-225
19	Locking balls	N-6121-051 (24 pcs)
22	Ball bearing assembly	80642-R1 (2 pcs)
	Crank bolt kit complete	205048
	Crank kit complete	205055
	Seal kit vacuum	205401
	Feedthrough assembling tool	240451
	VAT vacuum grease (40 g)	N-6951-012



Use only spare parts manufactured by VAT to assure safe and reliable operation All "

12.1.2 Control and actuating unit

Item	Description	Part number
	Valve size Product ordering number	All sizes 642 . . -
	Control and actuating unit	706511
	Option board with SPS module (±15 VDC sensor power supply)	371399
	Option board with PFO module (power failure option)	376419
	Option board with SPS and PFO module	376098
	Controller separation kit including 4.5m cable	

12.1.3 Accessories

Description	Part number
24 VDC power supply unit (input: 100 – 240 VAC)	572699
'Control Performance Analyzer' package for Windows®	free download from: http://www.vatvalve.com/customer-service/information-and-downloads/control-performance-analyzer
Service cable (PC to valve Service connector)	230327 free wiring information available for download from www.vatvalve.com
Connector kit consisting of: •DB-9 female POWER plug •DB-15 male SENSOR plug •DB-25 male INTERFACE plug (for RS232, RS485 and Logic only)	
Service Box 2	601BS-29NN-000
Control panel (rack-mount version of Service Box 2)	602BS-29LE-000
O-ring removal tool	234859
VAT valve cleaning tool	305709

12.1.3.1 Centering ring with Viton o-ring

Description		
Valve size Product ordering number		DN 200 / 8" 64246 -
Centering ring with Viton o-ring (for ISO-F installation only)	Aluminum	32046-QAZV
	Stainless steel	32046-QEZV

13 Appendix

No information entered on time.



This page left blank intentionally.