



RS232 / RS485 / Logic



Ether CAT



Device Net



Valve Cluster Slave  
(without interface)



CC-Link



Profibus



Ether Net

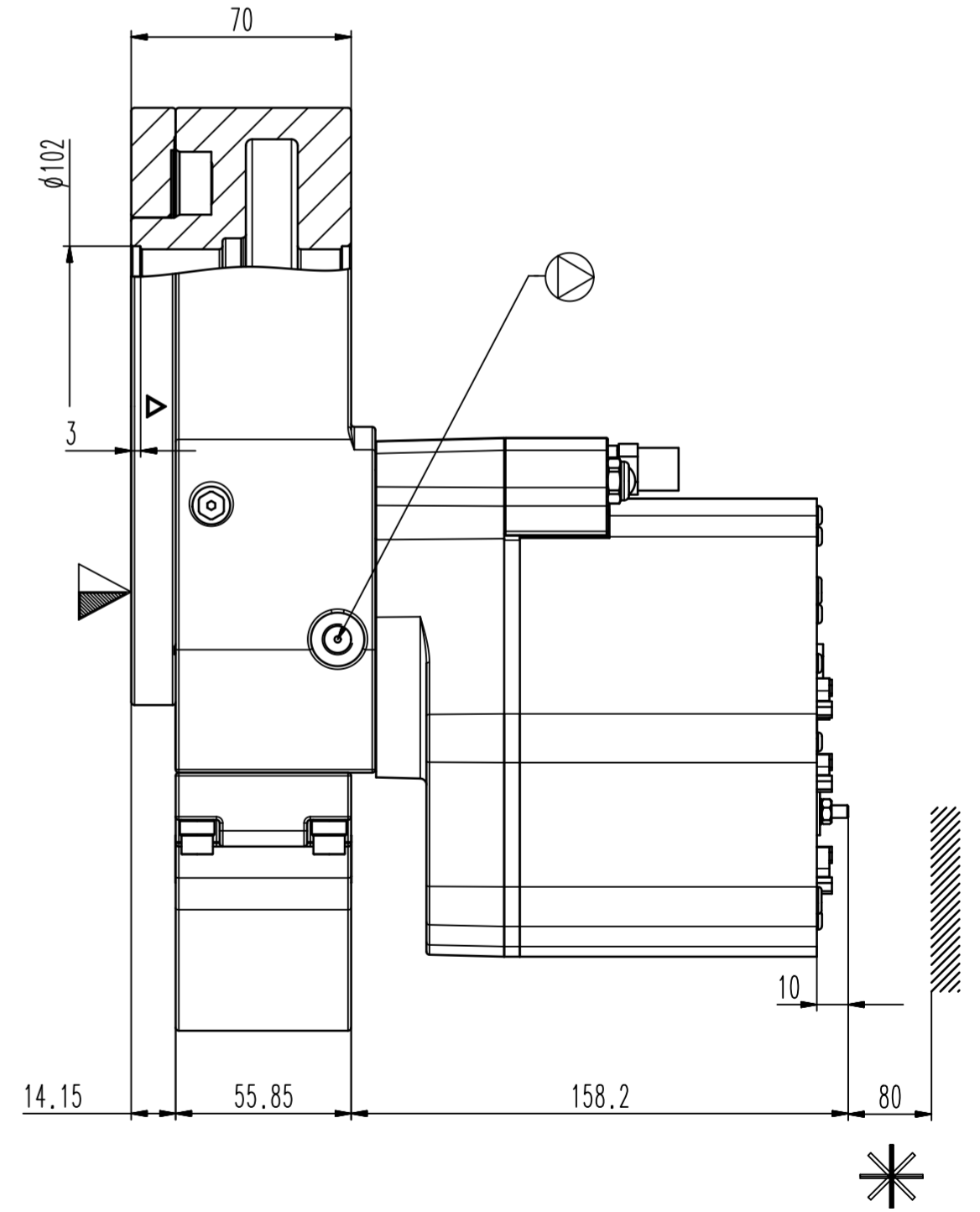
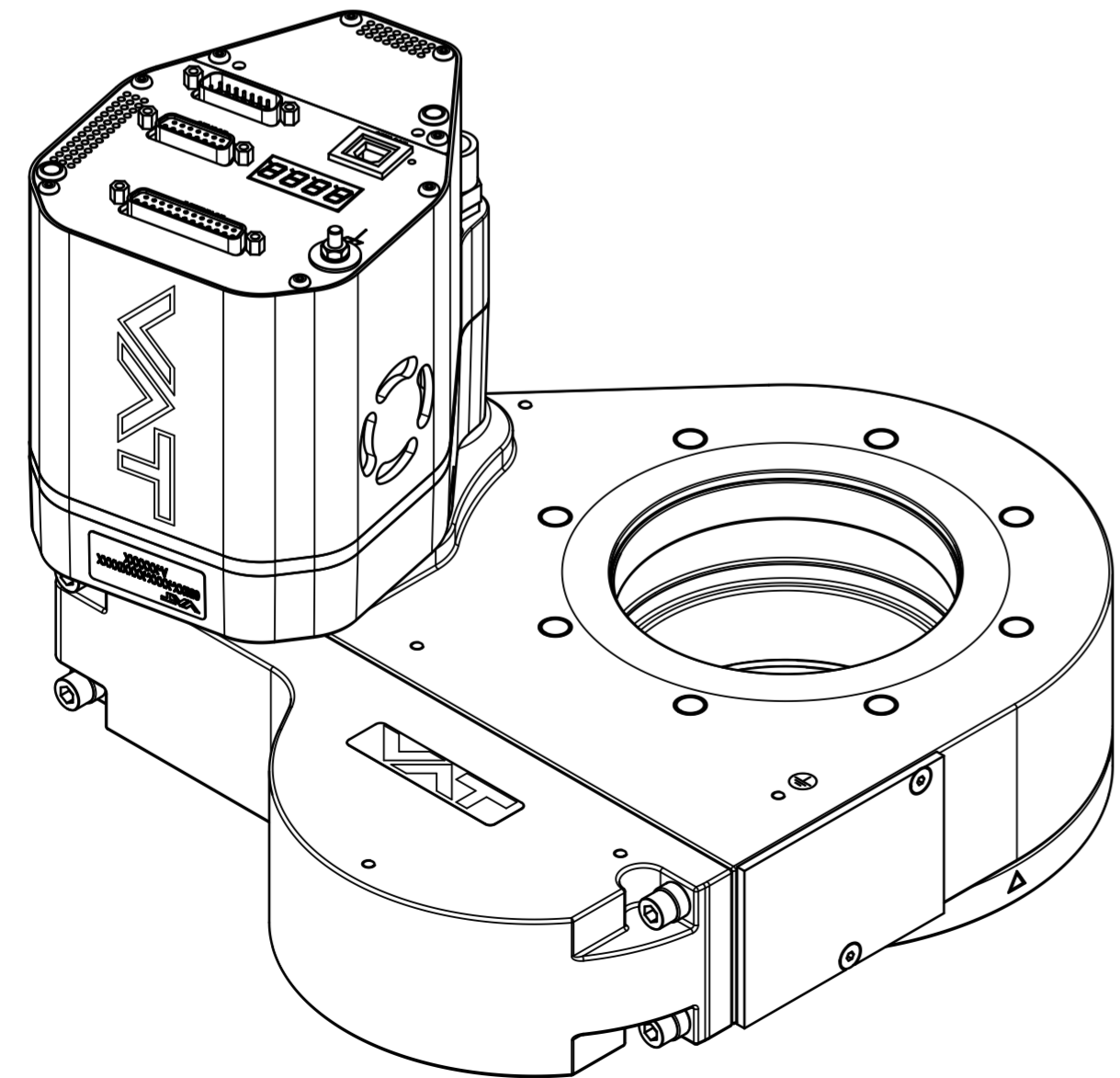

Revision

Customer number

- ▼ Seat side
- ◀ Comp. air connection
- ⊕ Electrical connection
- ⊙ Leak detection port
- ⊖ Mech. pos. indication
- ⊙ Position indicator
- ⊙ Required for dismantling
- ⊙ Emergency actuation
- ⊙ For attachment
- ⊙ Bake-out area
- ⊙ Differential pumping port

Control pendulum valve



VAT Vakuumventile AG  
CH-9469 Haag, Switzerland  
Tel: ++41 81 7716161 Fax: ++41 81 7714830

Rev.-Date: 20.02.24  
Visa: TANK

Series	653	Ordering No.	ISO Std
Projection E	DN	Flange	
	100		
Dimensional Drawing	1274188	Rev.	A