

Installation, Operating & Maintenance Instructions



Pendulum control & isolation valve with RS232 interface

Series 653 DN 100-250 mm (I.D. 4" - 10")

This manual is valid for the valve ordering number(s):

- 653GH - (2 sensor inputs / analog outputs)
- 653AH - (2 sensor inputs / analog outputs / $\pm 15V$ SPS)
- 653HH - (2 sensor inputs / analog outputs / PFO)
- 653CH - (2 sensor inputs / analog outputs / $\pm 15V$ SPS / PFO)

SPS = Sensor Power Supply PFO = Power Failure Option

configured with firmware: F01.0C.28.xx

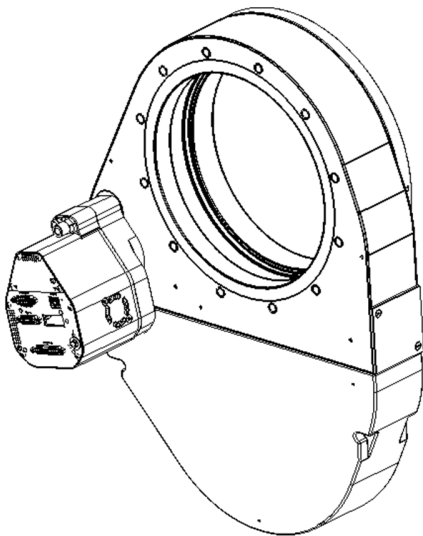

Sample picture

Imprint

Manufacturer VAT Vakuumventile AG, CH-9469 Haag, Switzerland

Website: www.vatvalve.com

Phone: +41 81 771 61 61

Fax: +41 81 771 48 30

Email: CH@vatvalve.com

Publisher VAT Vakuumventile AG, CH-9469 Haag, Switzerland

Editor VAT Vakuumventile AG, CH-9469 Haag, Switzerland

Print VAT Vakuumventile AG, CH-9469 Haag, Switzerland

Copyright © VAT Vakuumventile AG 2019

No part of these instructions may be reproduced in any way (photocopies, microfilms or any other reproduction processes) nor may it be manipulated with electronic systems, duplicated or distributed without written permission from VAT. Offenders are liable to pay damages.

The original VAT firmware and updated state of the art versions of the VAT firmware are intended for use with VAT products. The VAT firmware contains a limited, time unlimited user license. The VAT firmware may not be used for purposes other than those intended nor is it permitted to make copies of the VAT firmware. In particular, it is strictly forbidden to give copies of the VAT firmware to other people.

The use of trade names, brand names, trademarks, etc. in these Instructions does not entitle third parties to consider these names to be unprotected and to use them freely. This is in accordance with the meaning of the laws and acts covering brand names and trademarks.

Contents

1	Description of product.....	6
1.1	Identification of product	6
1.2	Use of product	6
1.3	Used abbreviations.....	6
1.4	Related documents.....	6
1.5	Important information.....	6
1.6	Technical data	7
1.6.1	Control and actuating unit	7
1.6.2	Valve unit	10
2	Safety	12
2.1	Compulsory reading material.....	12
2.2	Danger levels	12
2.3	Personnel qualifications.....	13
2.4	Safety labels.....	13
3	Design and Function.....	14
3.1	Design	14
3.2	Function.....	15
3.2.1	Pressure control system overview and function	16
3.2.2	Principle of a pressure control system	17
4	Installation	18
4.1	Unpacking	18
4.2	Installation into the system	19
4.2.1	Installation space condition	20
4.2.2	Connection overview.....	21
4.2.3	Installation procedure.....	22
4.2.4	Tightening torque	23
4.2.5	Mounting with centering rings	23
4.2.6	Mounting with O-ring in grooves	24
4.2.7	Admissible forces.....	25
4.2.8	Requirements to sensor connection.....	25
4.3	Electrical connection.....	26
4.3.1	Ground connection.....	27
4.3.2	Power and Sensor supply concepts.....	28
4.3.3	Digital Input/Output and analogue output connections.....	34
4.3.4	RS232 interface connection	39
4.3.5	Service port connection.....	39
4.4	Initial operation	40
4.5	Scaling of Pressure and Position Values.....	41
4.6	Valve configuration.....	42
4.6.1	Homing Start Option	42
4.6.2	Power Failure Option	42
4.6.3	Digital I/O	43
4.7	RS232 Interface configuration	44
4.7.1	RS232 interface configuration.....	44
4.8	Sensor configuration.....	44
4.8.1	Sensor configuration	44
4.8.2	Zero Adjust.....	47
4.9	Learn (adaptive control algorithm)	49
4.10	Pressure Control	51
4.10.1	Pressure control operation with 2 sensors	52
4.10.2	Control parameters	53
4.10.3	Choose correct control algorithm	57

4.10.4	Tuning of control performance	58
4.11	RS232 interface commands (IC protocol).....	68
4.11.1	RS232 command syntax	68
4.11.2	Control commands	68
4.11.3	Inquiry commands	69
4.11.4	Setup commands	74
4.11.5	Pressure control algorithm	84
4.11.6	Error messages	89
4.12	RS232 interface - commands (PM-V2 protocol)	90
4.12.1	Control commands (PM-V2 compatible).....	90
4.12.2	Inquiry commands (PM-V2 compatible)	91
4.12.3	Setup command (PM-V2 compatible).....	93
4.12.4	Sensor delay command (PM-V2 compatible)	94
4.12.5	Error messages (PM-V2 compatible)	94
5	Operation.....	95
5.1	Normal operation	95
5.1.1	Remote operation.....	95
5.1.2	Local operation.....	96
5.2	Close valve	97
5.3	Open valve.....	97
5.4	Position control	97
5.5	Pressure control.....	97
5.6	Display information	98
5.6.1	Power up	98
5.6.2	Operation	99
5.6.3	Error	99
5.6.4	Safety mode	99
5.7	Operation during power up	100
5.8	Behavior in case of power failure.....	100
5.9	Operation under increased temperature	101
5.10	Behavior In case of compressed air pressure drop.....	101
6	Trouble shooting	102
6.1.1	Controller Display	102
6.1.2	Error numbers	102
6.1.3	Error code	102
7	Maintenance.....	104
7.1	Maintenance intervals.....	104
7.2	Maintenance procedures	105
7.2.1	Replacement of isolation seals and valve cleaning	106
7.2.2	Replacement of actuator shaft seals	109
7.2.3	Replacement of Option board	114
7.2.4	Retrofit / replacement procedure.....	116
8	Repairs	118
9	Dismounting and Storage	119
9.1	Dismounting.....	119
9.2	Storage	120
10	Packaging and Transport.....	121
10.1	Packaging.....	121
10.2	Transport	122
11	Disposal.....	123

12	Spare parts	124
12.1	Drawing	124
12.1.1	Valve unit with seals and grease.....	125
12.1.2	Control and actuating unit	126
12.1.3	Accessories.....	127
13	Appendix.....	128

1 Description of product

1.1 Identification of product

The fabrication number and order number are fixed on the product directly or by means of an identification plate.

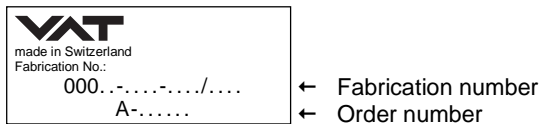

1.2 Use of product

This product is a throttling pendulum valve with isolation functionality. It is intended to use for downstream pressure control applications.
Use product for clean and dry vacuum applications only. Other applications are only allowed with the written permission of VAT.

1.3 Used abbreviations

Abbreviation	Description
CPA	Control Performance Analyzer
PFO	Power Failure Option
SFS	Sensor Full Scale
SPS	Sensor Power Supply
ADC	Analog-to-digital converter

1.4 Related documents

- Product Data Sheet
- Dimensional Drawing
- IOMI Heating device (if valve with heater)

1.5 Important information



This symbol points to a very important statement that requires particular attention.

Example:



Refer to chapter: «Technical data» for detailed information.

1.6 Technical data

1.6.1 Control and actuating unit

Description	
Power input ¹⁾ (α) [653 A / 653 H] [653 C / 653 H]	+24 VDC (±10%) @ 0.5 V pk-pk max. [connector: POWER] 70 W max. (operation of valve with max. load) without PFO ³⁾ with optional SPS + 40 W with optional PFO + 10 W ³⁾
Sensor power supply ²⁾ (β) [653 A / 653 C] Input Output	+24 VDC / 1500 mA max. [connector: POWER] ±15 VDC (±5%) / 1200 mA max. [connector: SENSOR]
Sensor power supply ²⁾ (β) [653 G / 653 H] Input Output	+ 24 VDC resp. ± 15 VDC [connector: POWER] same as input but: [connector: SENSOR] 2.0 A max. at ± 15 VDC 1.5 A max. at + 24 VDC
Actuator type	Stepper motor with servo control
Ingress Protection	IP30

1) Internal overcurrent protection by a PTC device.

2) Refer to chapter «Sensor supply concepts» for details.

3) PFO = Power Failure Option. Refer to «Behavior in case of power failure» for details.



Calculation of complete power consumption:

$$P_{\text{tot}} = \alpha + \beta$$

whereas β depends on sensor supply concept and sensor power consumption.

Control and actuating unit (continuation)		
Sensor input Signal input voltage ADC resolution Sampling time	-10 ... +10 V / $R_i = 100 \text{ k}\Omega$ 0.1 mV 2 ms	[connector: SENSOR]
Digital inputs (power connector) input 1 input 2 voltage control contact control	interlock open (adjustable with CPA 4.0) interlock close (adjustable with CPA 4.0) 12 ... 24V / 4 ... 8 mA 24V / 8 mA	[connector: POWER] [connector: POWER]
Digital outputs (power connector) output 1 output 2 load	valve closed (adjustable with CPA 4.0) valve opened (adjustable with CPA 4.0) max. 70 V / 0.1 A	[connector: POWER] [connector: POWER]
Digital inputs ⁴⁾ voltage control contact control	5 ... 24V / 2 ... 10 mA 3.3V / 2 mA	[connector: INTERFACE]
Digital outputs ⁴⁾ Input voltage Input current	max. 70 V max. 0.1 A	[connector: INTERFACE]
Analog outputs ⁴⁾	0-10 VDC / 1 mA max.	[connector: INTERFACE]
PFO ⁵⁾ battery pack [653 C / 653 H] Charging time Durability	2 minutes max. up to 10 years @ 25°C ambient; refer to «Durability of power fail battery» for details	
Compressed air supply	4 - 7 bar / 55 - 100 psi (above ATM)	
Ambient temperature	0 °C to +50 °C max. (<35 °C recommended)	
Pressure control accuracy	5 mV or 0.1% of setpoint, whichever is greater	

	DN 100 4" (65340 -)	DN 160 6" (65344 -)	DN 200 8" (65346 -)	DN 250 10" (65348 -)
Position resolution / position control capability	58000 steps (full stroke)			
Closing time throttling only (full stroke)	0.7 s typ. 0.4 s typ.	0.8 s typ. 0.45 s typ.	0.9 s typ. 0.5 s typ.	0.9 s typ. 0.5 s typ.
Opening time throttling only (full stroke)	0.7 s typ. 0.4 s typ.	0.8 s typ. 0.45 s typ.	0.9 s typ. 0.5 s typ.	0.9 s typ. 0.5 s typ.
Closing time throttling & isolation (full stroke)	3 s typ.	3 s typ.	3 s typ.	3 s typ.
Opening time throttling & isolation (full stroke)	4 s typ.	4 s typ.	4 s typ.	4 s typ.

4) Refer to chapter «Schematics» for details.

5) PFO = Power Failure Option. Refer to chapter «Behavior in case of power failure» for details.

Description				
- Seals	Viton® (standard). Other materials available. Seal materials are declared on dimensional drawing of specific valve ordering number.			
	DN 100 4" (65340 -)	DN 160 6" (65344 -)	DN 200 8" (65346 -)	DN 250 10" (65348 -)
Max. differential pressure on plate during isolation	1200 mbar in either direction	1200 mbar in either direction	1200 mbar in either direction	1200 mbar in either direction
Max. differential pressure on plate during opening and throttling	30 mbar	10 mbar	5 mbar	5 mbar
Min. controllable conductance (N ₂ molecular flow)	Typ. 2 l/s	Typ. 4 l/s	Typ. 7 l/s	Typ. 10 l/s
Dimensions	Refer to dimensional drawing of specific valve ordering number (available on request)			

2 Safety

2.1 Compulsory reading material

Read this chapter prior to performing any work with or on the product. It contains important information that is significant for your own personal safety. This chapter must have been read and understood by all persons who perform any kind of work with or on the product during any stage of its serviceable life.

	NOTICE
	<p>Lack of knowledge Failing to read this manual may result in property damage. Firstly, read manual.</p>



These Installation, Operating & Maintenance Instructions are an integral part of a comprehensive documentation belonging to a complete technical system. They must be stored together with the other documentation and accessible for anybody who is authorized to work with the system at any time.

2.2 Danger levels



	⚠ DANGER
	<p>High risk Indicates a hazardous situation which, if not avoided, will result in death or serious injury.</p>

	⚠ WARNING
	<p>Medium risk Indicates a hazardous situation which, if not avoided, could result in death or serious injury.</p>

	⚠ CAUTION
	<p>Low risk Indicates a hazardous situation which, if not avoided, may result in minor or moderate injury.</p>

	NOTICE
	<p>Command Indicates a hazardous situation which, if not avoided, may result in property damage.</p>

2.3 Personnel qualifications

	 WARNING
	Unqualified personnel Inappropriate handling may cause serious injury or property damage. Only qualified personnel are allowed to carry out the described work.

2.4 Safety labels

Label	Part No.	Location on valve
	T-9001-156	On protective foil covering of valve opening

3 Design and Function

3.1 Design

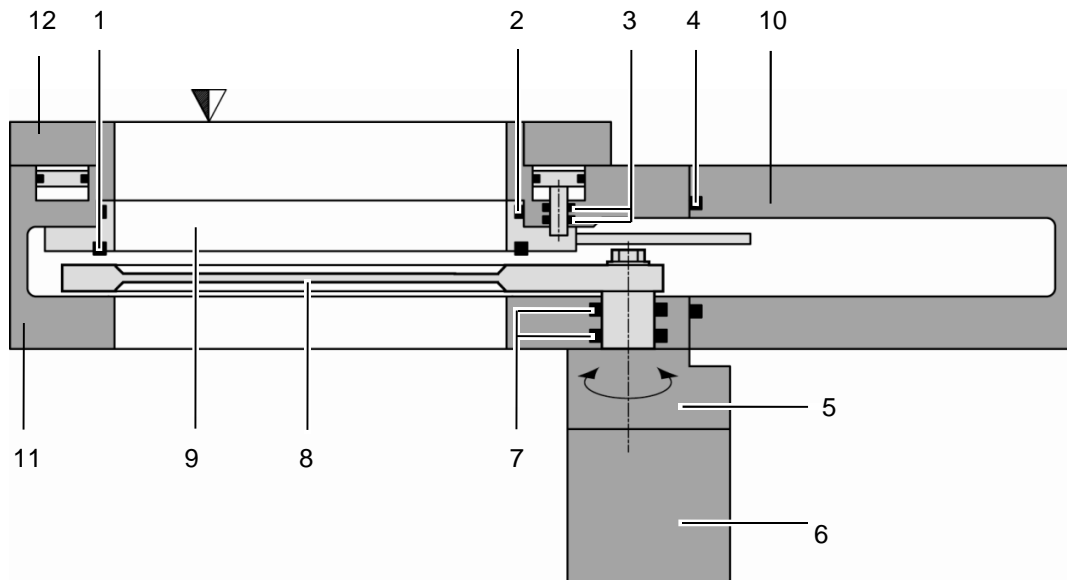

- | | | | |
|---|--------------------------|----|---------------------------|
| 1 | Plate seal | 7 | Rotary feed through seals |
| 2 | Body seal | 8 | Pendulum plate |
| 3 | Shaft feed through seals | 9 | Sealing ring |
| 4 | Bonnet seal | 10 | Bonnet |
| 5 | Actuator | 11 | Body |
| 6 | Integrated controller | 12 | Body Flange |

3.2 Function

The valve plate acts, due to its pendulum motion, as a throttling element and varies the conductance of the valve opening. The integrated controller calculates the required plate position to achieve the set point pressure. Actuation is performed by a stepper motor. An encoder monitors the position. This principle ensures fast and accurate process pressure control.

For opening or control the “sealing ring” is lifted pneumatically by “compressed air”, afterwards the “pendulum plate” moves to open or do pressure control. For leak tight closing, the “sealing ring” moves downwards and press the pendulum plate to valve body for “isolation”. Closing is performed by “springs”.

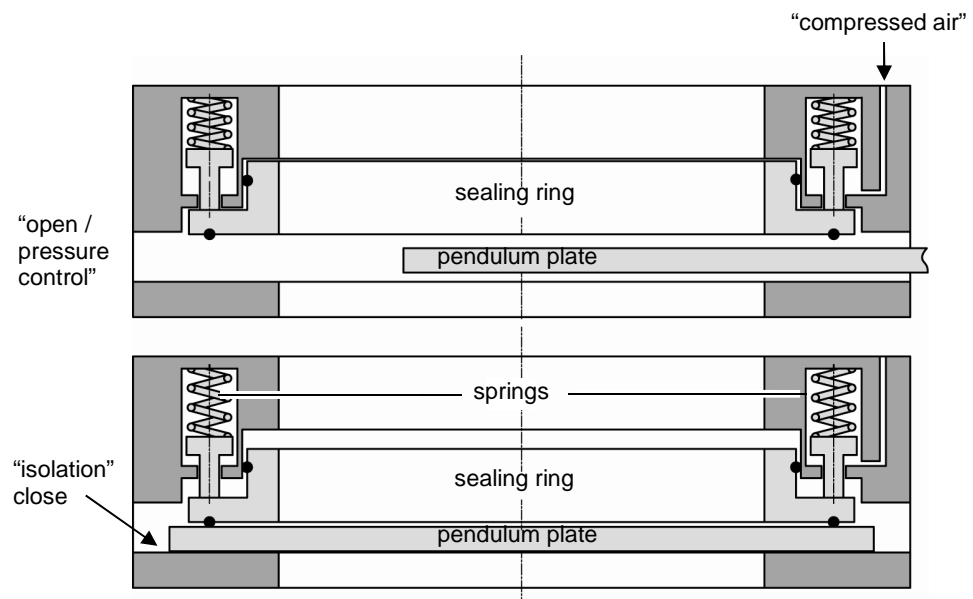

3.2.1 Pressure control system overview and function

Vacuum pressures are always absolute pressures unless explicitly specified as pressure differences.

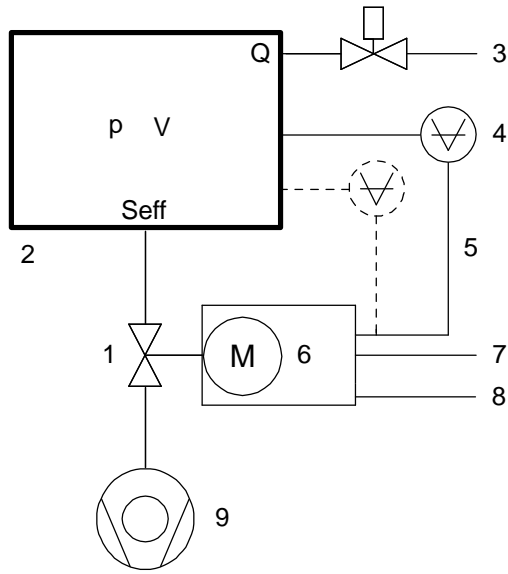

- 1 Valve
- 2 Process chamber
- 3 Gas inlet
- 4 Pressure sensor(s)
- 5 Sensor cable
- 6 Controller and actuator
- 7 Cable to remote control unit
- 8 Cable to power supply
- 9 HV Pump

$S_{eff} = Q / p$
 S_{eff} effective pump speed ($l s^{-1}$)
 Q Gas flow ($mbar l s^{-1}$)
 p Pressure ($mbar$)

or units used in USA
 $S_{eff} = 12.7 \cdot Q / p$
 S_{eff} effective pump speed ($l s^{-1}$)
 Q Gas flow (sccm)
 p Pressure (mTorr)
 V Volume

Example: Downstream control

3.2.1.1 Way of operation

The controller compares the actual pressure in the process chamber given by the pressure sensor with the preset pressure. The controller uses the difference between actual and set pressure to calculate the correct position of the control valve. The controller drives the control valve into the correct position and the actual pressure again equals the set pressure.

This control operation is performed continuously. Pressure changes in the process chamber due to leaks, desorption, and gas flow, reaction products, variations in pumping speed etc. are always corrected at once.

3.2.1.2 Pressure control

In a vacuum system which is pumped and into which gas is admitted at the same time, the pressure can be controlled in two ways:

1. Downstream control (standard):
The pressure is controlled by changing the conductance of a control valve between pump and process chamber. This changes the effective pumping speed at the process chamber. Pressure and gas flow can be independently controlled over a wide range.
2. Upstream control:
The pressure is controlled by changing the gas flow into the process chamber, while the pumping speed remains constant.

3.2.1.3 Adaptive controller (standard)

A controller adapting itself to changes in pressure, gas flow and pumping speed without any manual adjustments. This allows for a completely automatic operation of the system.

3.2.2 Principle of a pressure control system

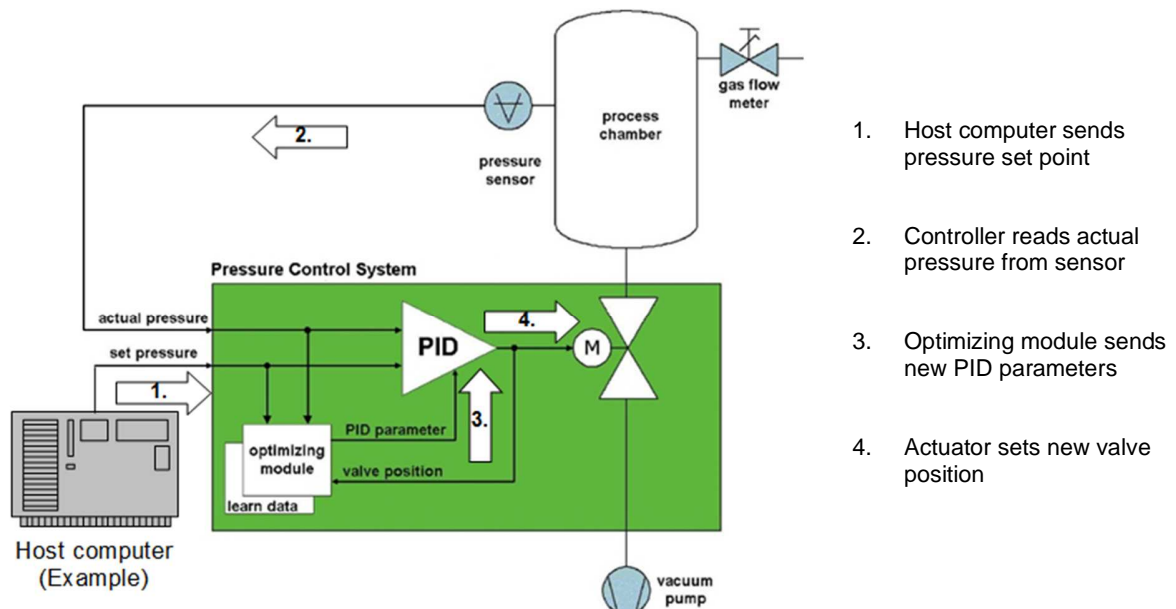

4 Installation

	WARNING
	<p>Unqualified personnel Inappropriate handling may cause serious injury or property damage. Only qualified personnel are allowed to carry out the described work.</p>

4.1 Unpacking

	NOTICE
	<p>Physical overstraining at controller Inappropriate handling with the valve may cause in damage of controller. Do not place the valve on the controller.</p>

	CAUTION
	<p>Valve is a heavy component Physical overstraining. Use a crane to lift valves DN 200 (8") and larger.</p>









- Make sure that the supplied products are in accordance with your order.
- Inspect the quality of the supplied products visually. If it does not meet your requirements, please contact VAT immediately.
- Store the original packaging material. It may be useful if products must be returned to VAT.

1. Open the transport case and remove inside packing material as far as necessary.
2. Attach lifting device for valves DN 200 (8") and larger. For attachment refer to dimensional drawing of valve.
3. Lift the valve carefully and place it on a clean place.



Do not remove protective foils from valve opening

4.2 Installation into the system

	<p style="text-align: center;">⚠ WARNING</p> <p>Valve opening Risk of serious injury. Human body parts must be kept out of the valve opening and away from moving parts. Do not connect the controller to power before the valve is installed complete into the system.</p>
	<p style="text-align: center;">⚠ WARNING</p> <p>Valve in open position Risk of injury when compressed air is connected to the valve. Connect compressed air only when: – valve is installed in the vacuum system – moving parts cannot be touched</p>
	<p style="text-align: center;">NOTICE</p> <p>Sealing surfaces Sealing surfaces of valve and vacuum system could be damage in case of incorrect handling. Only qualified personal are allowed to install the valve into the vacuum system.</p>
	<p style="text-align: center;">NOTICE</p> <p>Wrong connection Wrong connection may result in damage of controller or power supply. Connect all cables exactly as shown in the following descriptions and schematics.</p>
	<p style="text-align: center;">NOTICE</p> <p>Burned connector pins (spark) Connector pins or electronic parts could damage, if plugged and unplugged under power. Do not plug or unplug connectors under power.</p>
	<p style="text-align: center;">NOTICE</p> <p>Contamination Gate and other parts of the valve must be protected from contamination. Always wear clean room gloves when handling the valve.</p>



Mount valve to a clean system only.

4.2.1 Installation space condition



Install the valve with integrated controller with space for dismantling and air circulation as shown in figure below.

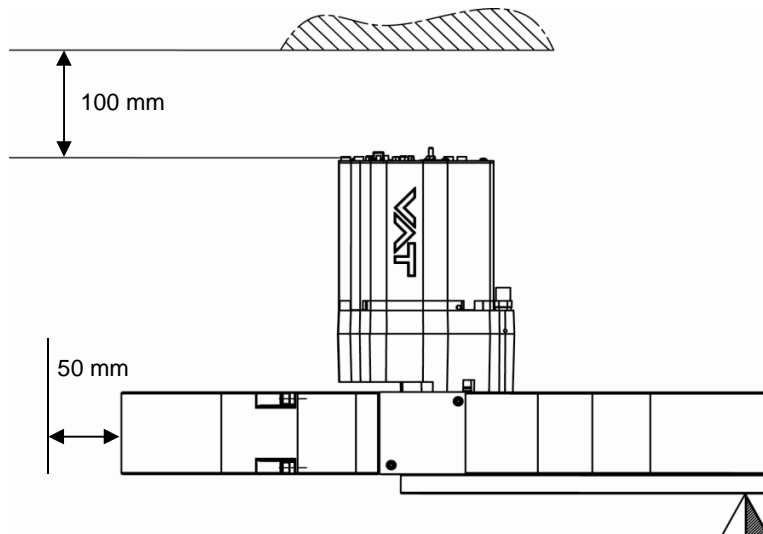

4.2.2 Connection overview

System:

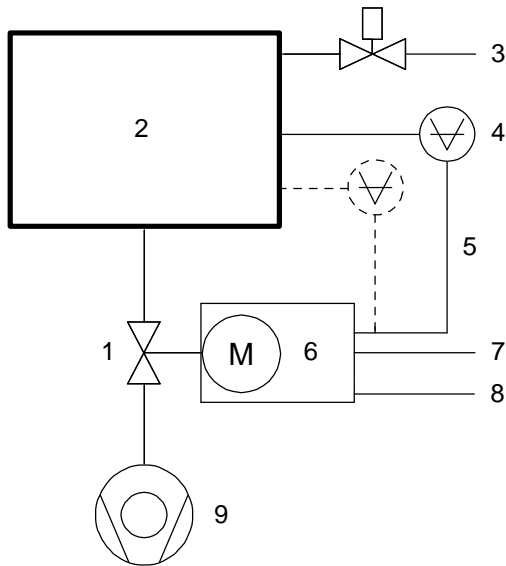

- 1 Valve
- 2 Process chamber
- 3 Gas inlet
- 4 Pressure sensor(s)
- 5 Sensor cable(s)
- 6 Controller and actuator
- 7 Cable to remote control unit
- 8 Cable to power supply
- 9 Pump

Controller:

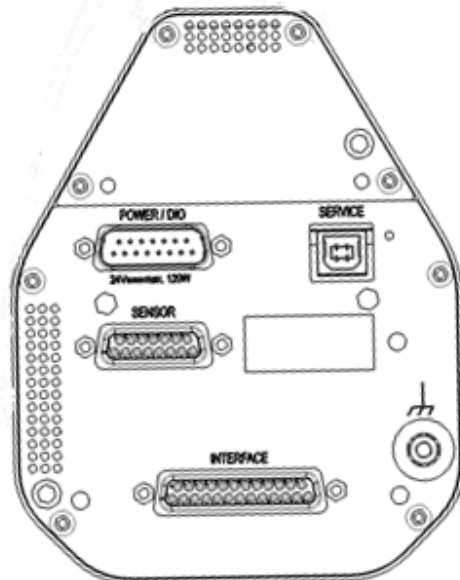

4.2.3 Installation procedure

1. Install valve [1] into the vacuum system. Valve seat side should face process chamber. The valve seat side is indicated by the symbol "▽" on the valve flange.



- Do not tighten the flange screws stronger than indicated under «Tightening torque».
- Do not admit higher forces to the valve than indicated under «Admissible forces».
- Make sure that enough space is kept free to do preventive maintenance work. The required space is indicated on the dimensional drawing.

2. Connect compressed air supply to connection labeled '**IN**' located at actuator, see Figure 1 below. Connect compressed air return line connection labeled '**OUT**' located at actuator, see Figure 1 below.



- Compressed air pressure must be in the range of: **4 - 7 bar / 55 - 100 psi (above ATM)**.
- Use only clean, dry or slightly oiled air. IN / OUT connections are 1/8" ISO/NPT internal threads.

3. Install the ground connection cable at controller. Refer to «Electrical connection»
4. Install pressure sensor(s) [2] according to the recommendations of the sensor manufacturer and directives given under «Requirements to sensor connection».
5. Connect sensor cable [3] to sensor(s) and then to valve (connector: SENSOR). Refer to chapter «Electrical connection» for correct wiring.
6. Connect valve to RS232 [4] (connector: INTERFACE). Refer to «Function and Wiring» for correct wiring.
7. Connect power supply [5] to valve (connector: POWER). Refer to chapter «Electrical connection» for correct wiring.



To provide power to the valve motor pins 4 and 11 must be bridged, otherwise motor interlock is active and the valve enters the safety mode and is not operative. Refer also to «Safety mode».

8. This valve has a double sealed rotary feedthrough and optionally an intermediate pumping port for the actuator shaft. This port (1/8" ISO/NPT) could be connected to the vacuum line, see Figure 3 below.
9. This valve may optionally be equipped with a heating device. Connect VAT heating device according to manual of respective heating device.
10. Perform «Setup procedure» to prepare valve for operation.



Without performing the setup procedure the valve will not be able to do pressure control.

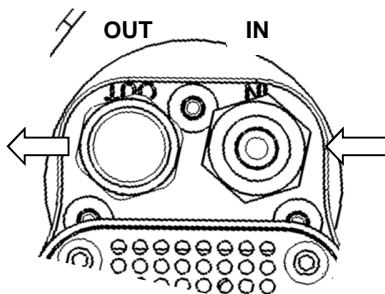

Fig. 1



Fig. 2

4.2.4 Tightening torque



The torque values below are dependent on many factors, such as materials involved, surface quality, surface treatment, and lubrication.

The torques below are valid if immersion depth of the mounting screws is at least once the thread diameter (min. 1d), and the friction coefficient of the screw-flange connection ($\mu_{total} = (\mu_{screw\ thread-helicoil} + \mu_{under\ screw\ head})/2$) is bigger than 0.12. Lower friction coefficients may damage the valve, as the resulting preload force gets too high. Therefore for other friction coefficients the torque needs to be adapted. Please review design guidelines for Helicoil-Screw connections and make sure that screws in use are capable to withstand applied torques, are appropriate for the application and are not too long. Too long screws may damage the valve, the immersion depth should not exceed (hole depth – 1 mm).

Tighten mounting screws of the flanges uniformly in crosswise order. Observe the maximum torque levels in the following tables.

4.2.5 Mounting with centering rings

Valve size	ISO-F	ISO-F
	max. tightening torque (Nm)	max. tightening torque (lbs . ft)
DN100 / 4" (65340 - -)	8-10	6-8
DN160 / 6" (65344 - -)	13-15	9-11
DN200 / 8" (65346 - -)	13-15	9-11
DN250 / 10" (65348 - -)	17-20	13-15
	hole depth (mm)	hole depth (inch)
DN100 / 4" (65340 - -)	12	0.47
DN160 / 6" (65344 - -)	14	0.55
DN200 / 8" (65346 - -)	15	0.59
DN250 / 10" (65348 - -)	16	0.63

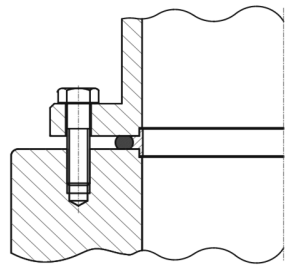



Refer to «Spare parts / Accessories» for centering rings ordering numbers.

4.2.6 Mounting with O-ring in grooves

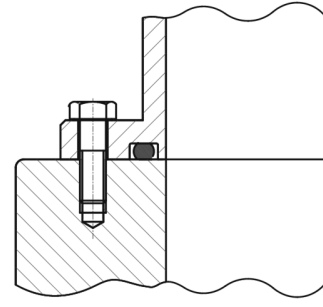
Valve size	ISO-F	JIS	ASA-LP	ISO-F	JIS	ASA-LP
	max. tightening torque (Nm)			max. tightening torque (lbs . ft)		
DN100 / 4" (65340 -)	20-23	35-40	35-40	15-17	26-30	26-30
DN160 / 6" (65344 -)	35-40	35-40	35-40	26-30	26-30	26-30
DN200 / 8" (65346 -)	35-40	35-40	80-90	26-30	26-30	59-67
DN250 / 10" (65348 -)	35-41	65-70	80-90	26-30	48-52	59-67
	hole depth (mm)			hole depth (inch)		
DN100 / 4" (65340 -)	12	12	12	0.47	0.47	0.47
DN160 / 6" (65344 -)	14	14	14	0.55	0.55	0.55
DN200 / 8" (65346 -)	15	15	14	0.59	0.59	0.59
DN250 / 10" (65348 -)	16	16	16	0.63	0.63	0.63



4.2.7 Admissible forces

 NOTICE
<p>Force at valve body</p> <p>Forces from evacuating the system, from the weight of other components, and from baking can lead to deformation and malfunctioning of the valve.</p> <p>Do not higher force the valve body as specified.</p>



The following forces are admissible.

Valve size	Axial tensile or compressive force «F _A »		Bending moment «M»	
	N	lb.	Nm	lbf.
DN100 / 4" (65340 - -)	1000	220	40	30
DN160 / 6" (65344 - -)	2000	440	80	60
DN200 / 8" (65346 - -)	2000	440	80	60
DN250 / 10" (65348 - -)	2500	550	100	75
<p>For a combination of both forces (F_A and M) the values are invalid. Verify that the depth of the mounting screws is min. 1 x thread diameter. Please contact VAT for more information.</p>				

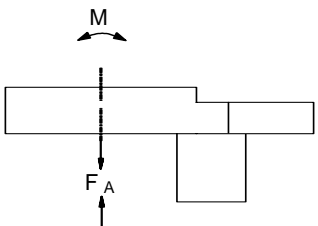

4.2.8 Requirements to sensor connection

To achieve fast and accurate pressure control a fast sensor response is required. Sensor response time: < 50ms. The sensor is normally connected to the chamber by a pipe. To maintain that the response time is not degraded by this connection it needs to meet the following requirements:

- Inner diameter of connection pipe: **> = 10 mm**
- Length of connection pipe: **< = 300 mm**

These conductance guidelines must include all valves and limiting orifices that may also be present. Make also sure that there is no obstruction in front of sensor connection port inside the chamber. The sensor should also be mounted free of mechanical shock and vibration. Dynamic stray magnetic fields may introduce noise to sensor output and should be avoided or shielded.

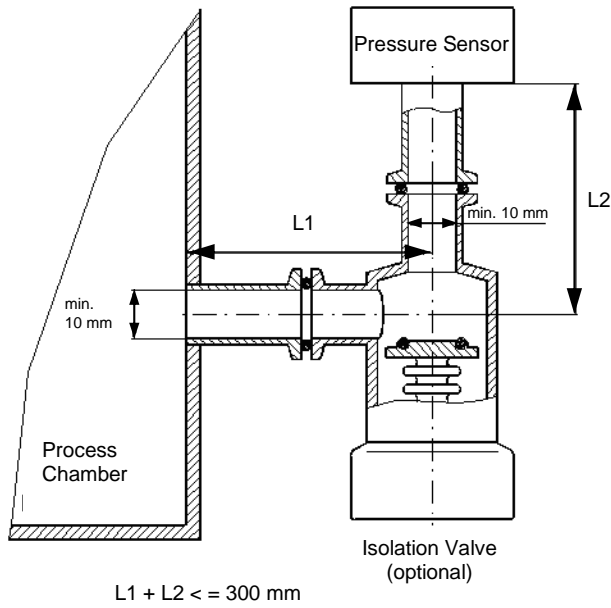

4.3 Electrical connection

	<p style="text-align: right;">NOTICE</p> <p>Wrong connection Wrong connection may result in damage of controller or power supply. Connect all cables exactly as shown in the following descriptions and schematics.</p>
	<p style="text-align: right;">NOTICE</p> <p>Burned connector pins (spark) Connector pins or electronic parts could damage, if plugged and unplugged under power. Do not plug or unplug connectors under power.</p>

4.3.1 Ground connection

Recommendation for ground strap between controller and system chassis.

Material	L (Length max.)	B1 (min.)	B2 (min.)	d1 (Ø)	d2 (Ø)
copper tinned	200 mm	25 mm	25 mm	4.5 mm	customized

Recommended torque: 1,3...1,7Nm

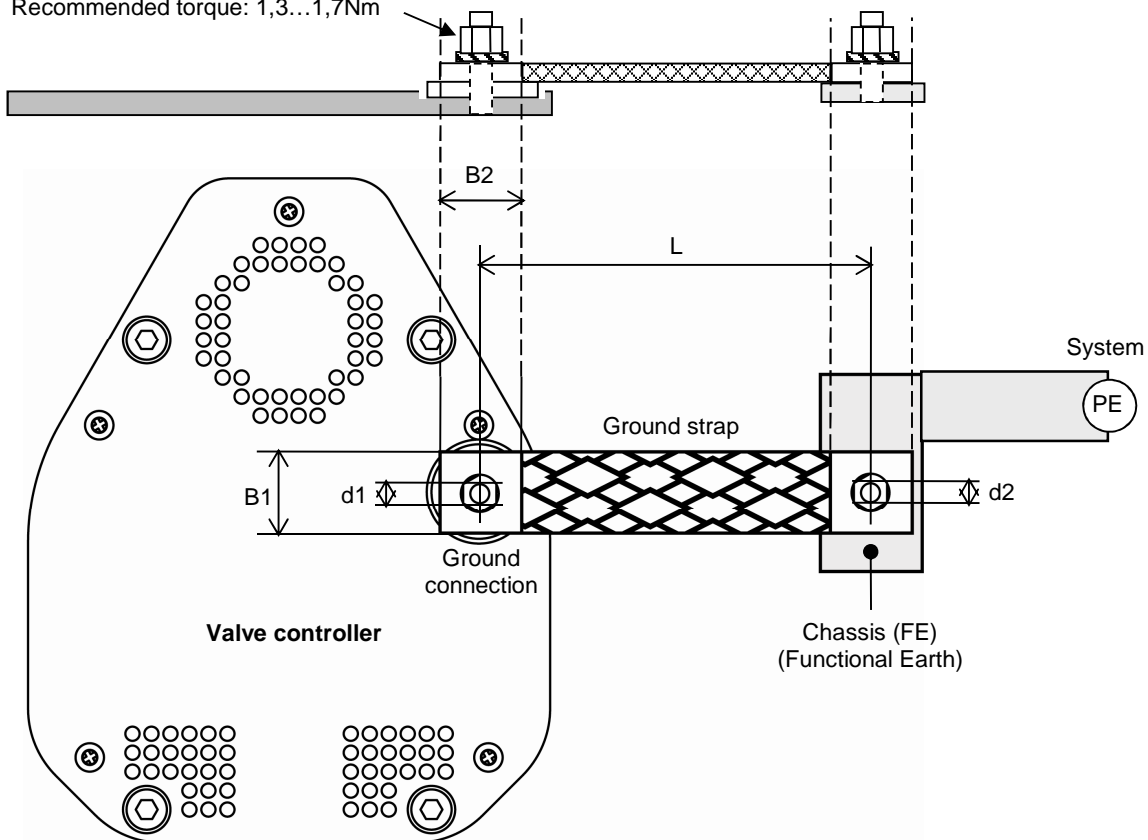

sample picture



Connection plates of ground strap must be total plane for a good electrical contact!

The connection point at chassis (FE) must be blank metal (not coated).
It is also possible to connect the ground strap at system chamber if it is well connected to PE.

Avoid low chassis cross section to the system PE connection. (min. same cross section as ground strap)

4.3.2 Power and Sensor supply concepts

This valve offers 3 alternative concepts to supply the sensor(s) with power. This depends on the sensor type and valve version that is used. This valve is available with an optional sensor power supply module (SPS) that converts ± 15 VDC from the 24 VDC.

Concepts:

- External +24 VDC supplied to POWER connector is feedthrough to SENSOR connector to supply 24 VDC sensors. Refer to chapter «Power and sensor connection (+24 VDC sensors)» for schematic and correct wiring.
- External ± 15 VDC supplied to POWER connector is feedthrough to SENSOR connector to supply ± 15 VDC sensors. Refer to chapter «Power and sensor connection (± 15 VDC sensors) without optional SPS module» for schematic and correct wiring.
- External +24 VDC supplied to POWER connector is converted into ± 15 VDC by the valve internal SPS and supplied to SENSOR connector to supply ± 15 VDC sensors. Refer to chapter «Power and sensor connection (± 15 VDC sensors) with optional SPS module» for schematic and correct wiring.



This concept is only possible when SPS retrofit is installed.

Valve versions:

- 653 **G** and 653 **H** SPS module not included
- 653 **A** and 653 **C** SPS module included



The SPS module can be retrofitted. Refer to chapter «Retrofit / replacement procedure» for instruction.

4.3.2.1 Power and sensor connection (+24 VDC sensors) via controller

[653 G / 653 H versions recommended]

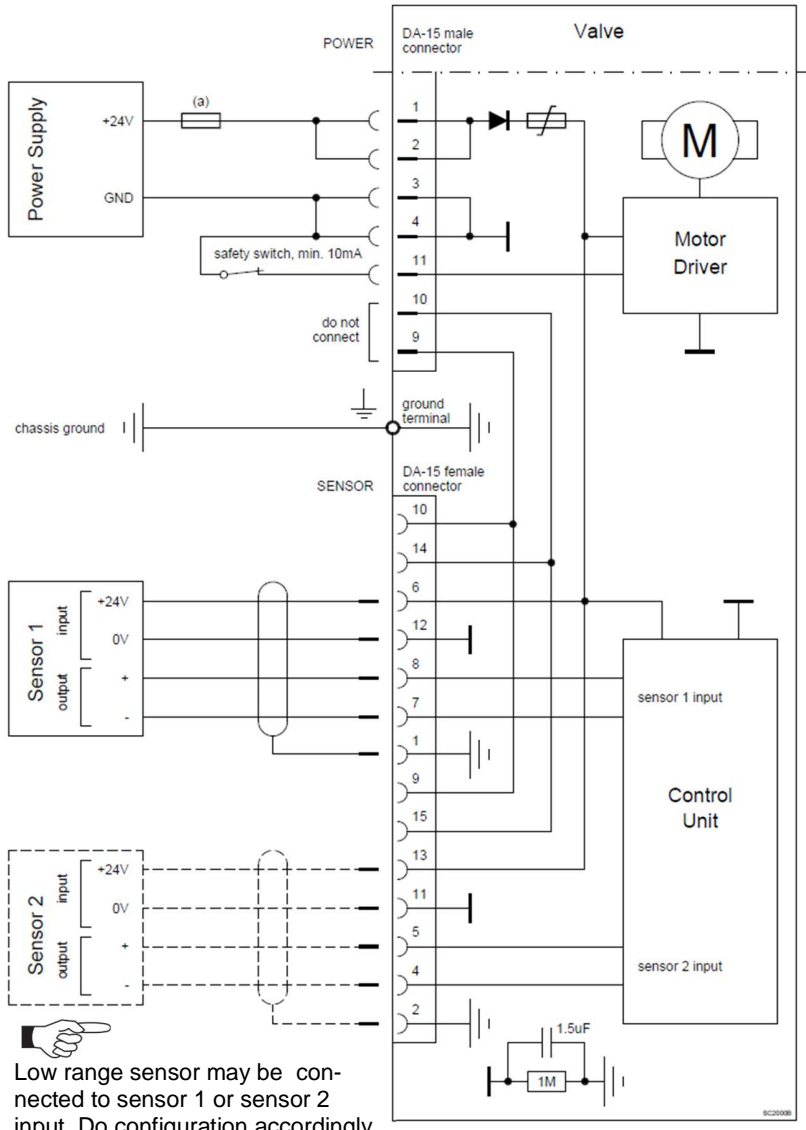

Pins 4 and 11 must be bridged for operation. An optional switch would allow for motor interlock to prevent valve from moving.

Low range sensor may be connected to sensor 1 or sensor 2 input. Do configuration accordingly



- **VAT fuse recommendation: (a) 7 AF**
- Use shielded sensor cable(s). Keep cable as short as possible, but locate it away from noise sources.
- Connect Power supply (+24 / GND) at DA-15 male power connector and Sensors (+24V / 0V / + / -) at DA-15 female sensor connector exactly as shown in the drawing above!
- Connector: Use only screws with 4-40 UNC thread for fastening the connectors!

4.3.2.2 Power and sensor connection (+24 VDC sensors) external

[653 G / 653 H versions recommended]

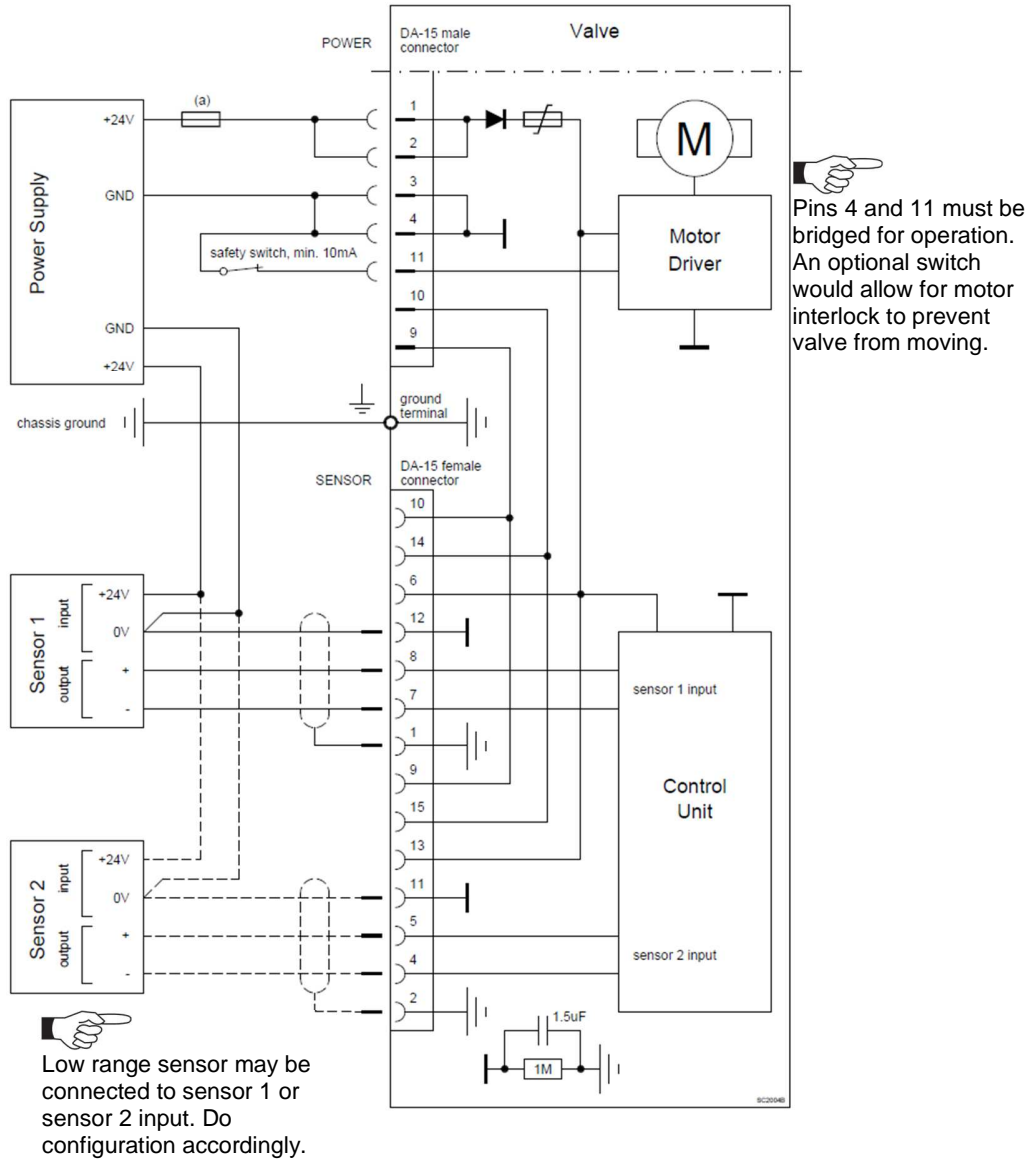

- **VAT fuse recommendation: (a) 5 AF**
- Use shielded sensor cable(s). Keep cable as short as possible, but locate it away from noise sources.
- Connect Power supply (+24 / GND) at DA-15 male power connector and Sensors (0V / + / -) at DA-15 female sensor connector exactly as shown in the drawing above!
- Connector: Use only screws with 4-40 UNC thread for fastening the connectors!

4.3.2.4 Power and sensor connection (± 15 VDC sensors) without opt. SPS module external

[653 G / 653 H versions recommended]

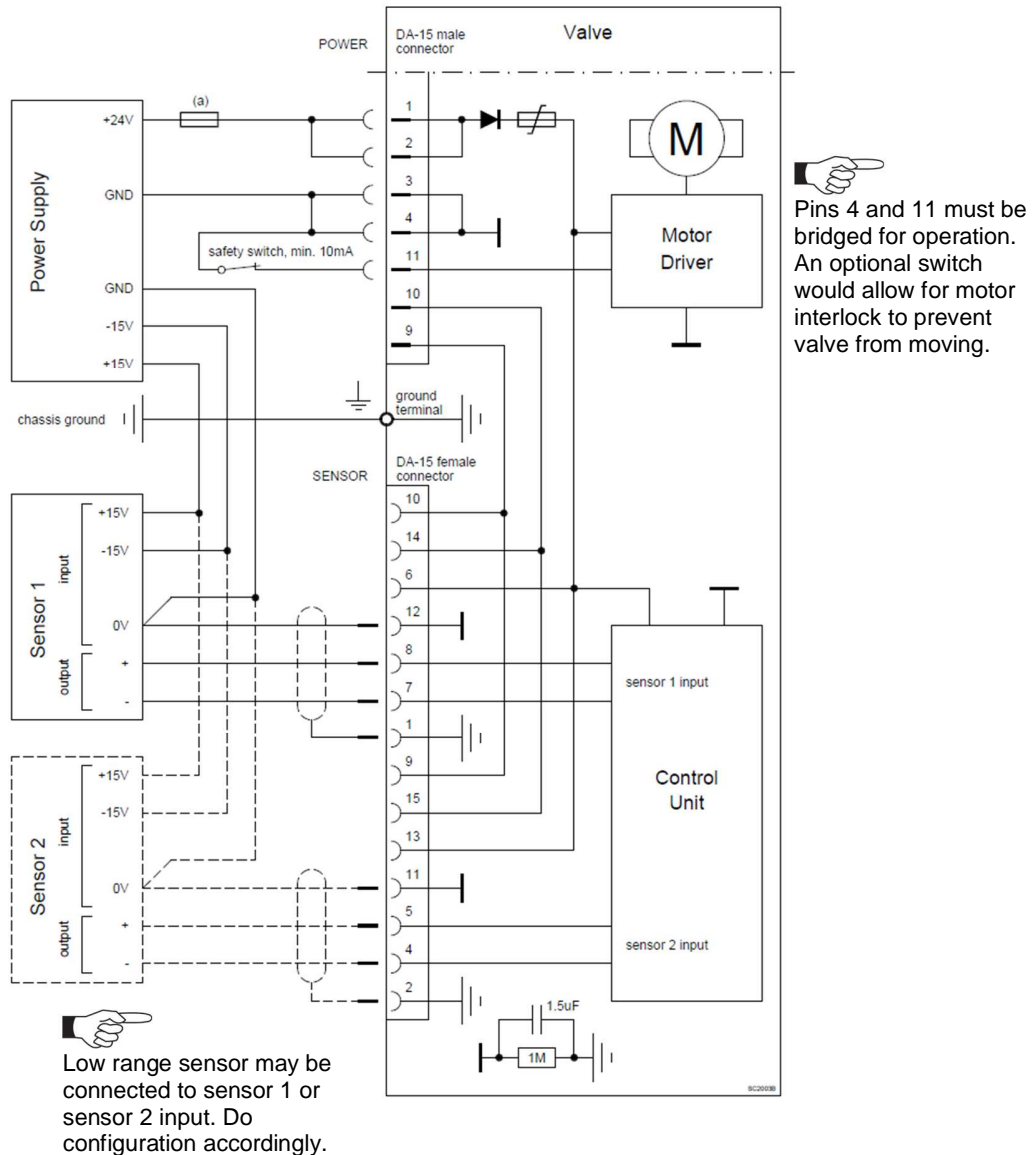

- **VAT fuse recommendation: (a) 5 AF**
- Use shielded sensor cable(s). Keep cable as short as possible, but locate it away from noise sources.
- Connect Power supply (+24 / GND) at DA-15 male power connector and Sensors (0V / + / -) at DA-15 female sensor connector exactly as shown in the drawing above!
- Connector: Use only screws with 4-40 UNC thread for fastening the connectors!

4.3.2.5 Power and sensor connection (± 15 VDC sensors) with optional SPS module

[653 A / 653 C versions only]

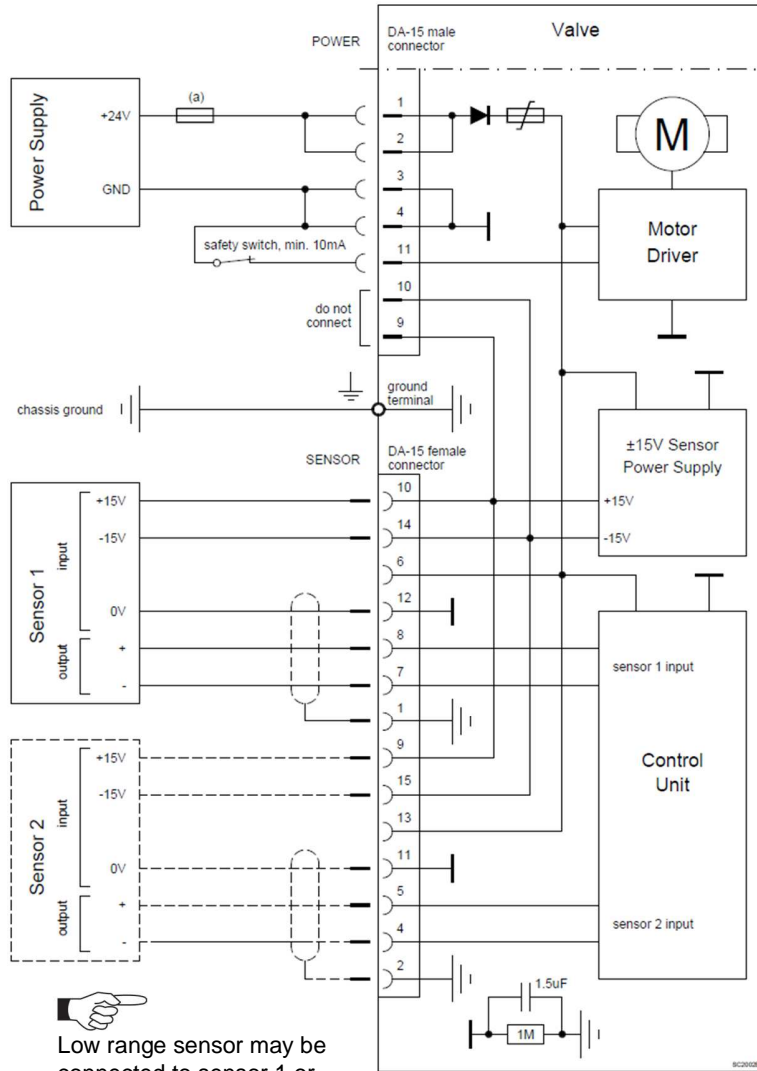

Pins 4 and 11 must be bridged for operation. An optional switch would allow for motor interlock to prevent valve from moving.

Low range sensor may be connected to sensor 1 or sensor 2 input. Do configuration accordingly.



- **VAT fuse recommendation: (a) 7 AF**
- Use shielded sensor cable(s). Keep cable as short as possible, but locate it away from noise sources.
- Connect Power supply (+24 / GND) at DA-15 male power connector and Sensors (+15V / -15V / 0V / + / -) at DA-15 female sensor connector exactly as shown in the drawing above!
- Connector: Use only screws with 4-40 UNC thread for fastening the connectors!

4.3.3 Digital Input/Output and analogue output connections

This interface allows for remote operation by means of a command set based on the RS232 protocol. In addition there are 2 digital inputs and 2 digital outputs. Digital inputs may be operated either by switches or by voltage sources.



Digital inputs on the **POWER and INTERFACE connector** have the **same priority**.



Active **digital inputs** have **higher priority than RS232** commands.



Do not connect other pins than indicated in the schematics above!
Use only screws with 4-40UNC thread for fastening the DA-15 / DB-25 connector!

4.3.3.1 Power connector: Configuration with switches for digital inputs “Interlock”

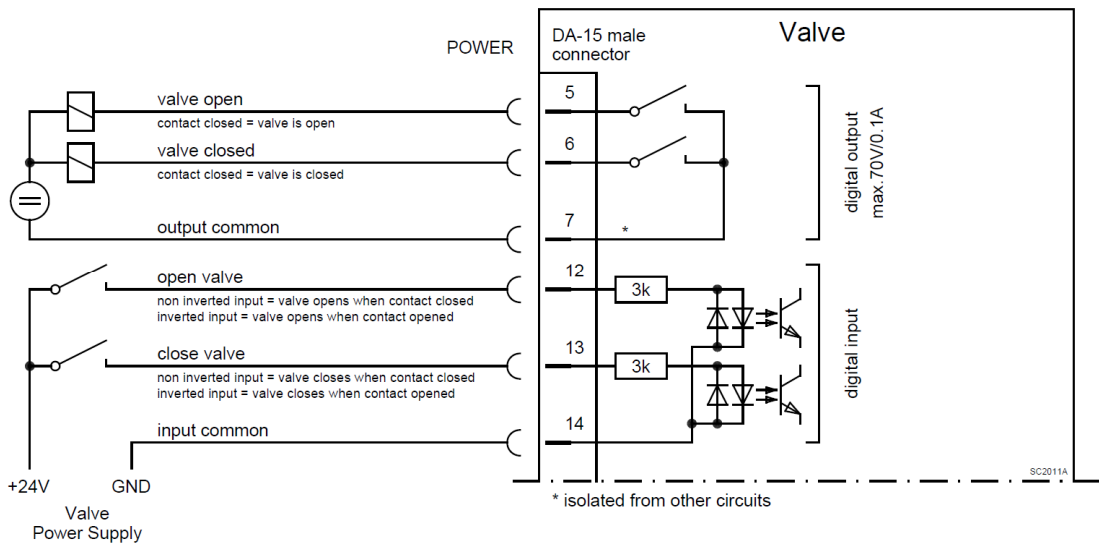

4.3.3.2 Power connector: Configuration with voltage source for digital inputs “Interlock”

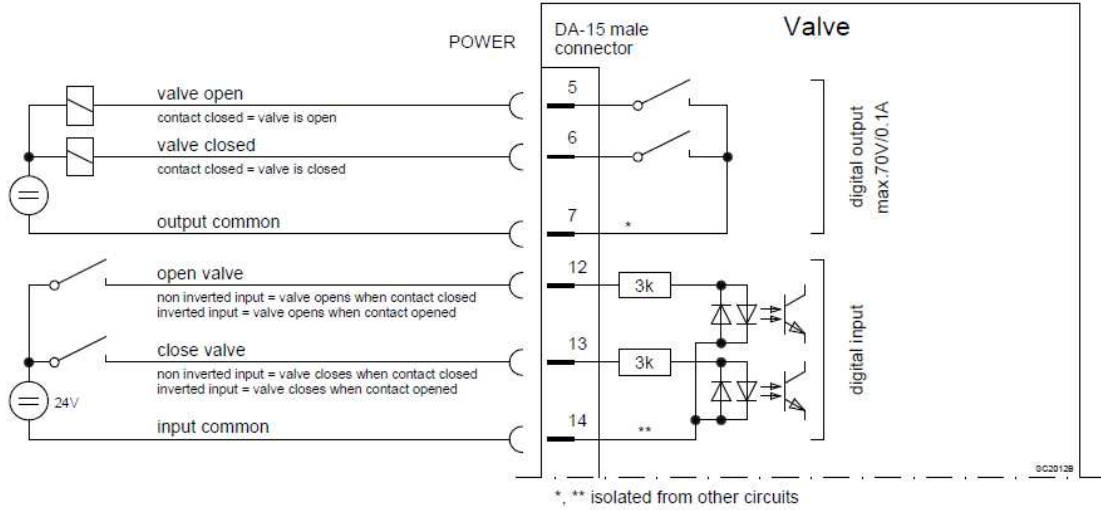

4.3.3.3 Interface Connector: Configuration with switches for digital inputs

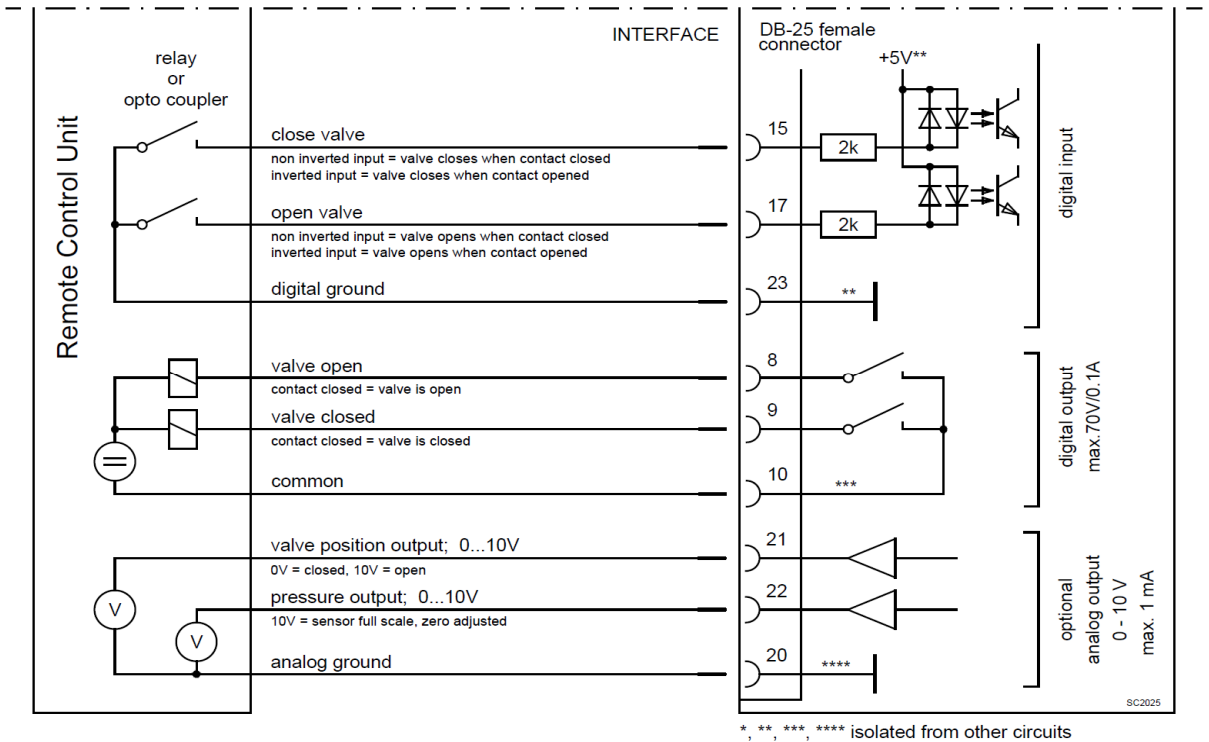

4.3.3.4 Interface Connector: Configuration with voltage source for digital inputs

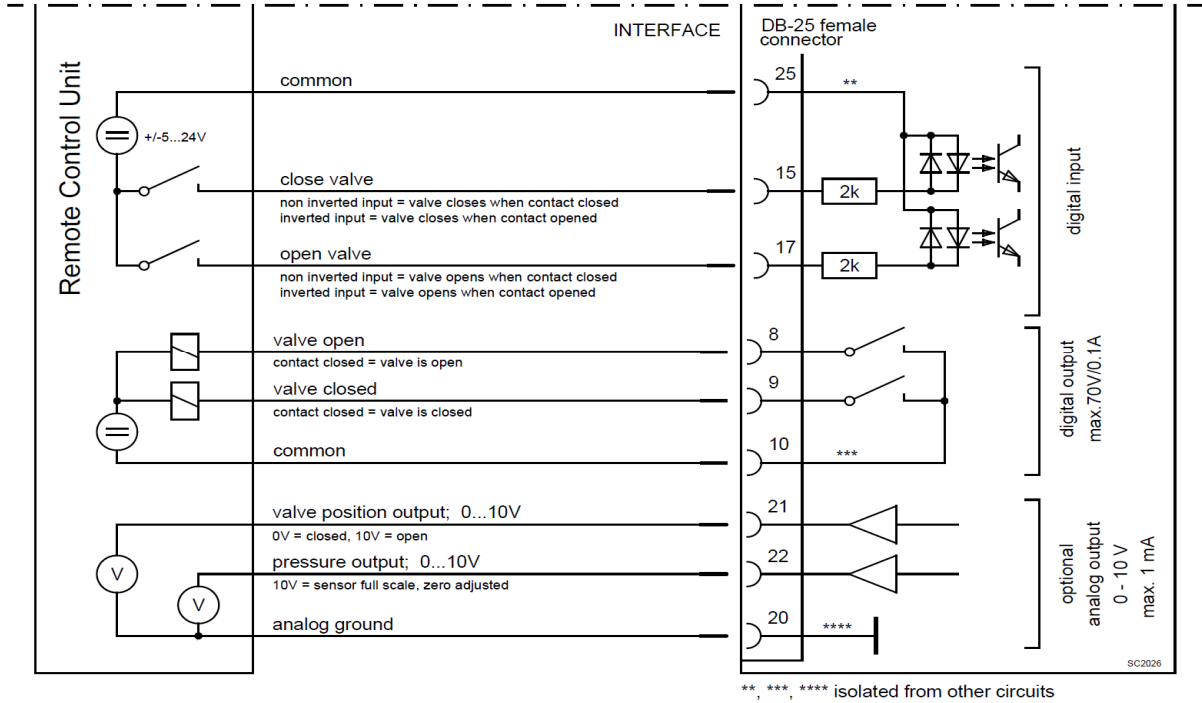

** , *** , **** isolated from other circuits

4.3.3.5 Digital inputs (Interface connector)

Pin	Function	Signal type	Description	Priority
15	CLOSE VALVE	Digital input ¹⁾	<p>This function will close the valve. Valve will be in interlock mode as long as function is activated. After deactivation of function it will remain effective until</p> <ul style="list-style-type: none"> - OPEN valve digital input is active - converse RS232 control command have been received <p>The function is activated when optocoupler is 'on' in non inverted configuration.</p> <p>The function is activated when optocoupler is 'off' in inverted configuration.</p> <p>Configuration can be done in local operation via service port or in remote operation.</p>	1 ²⁾
17	OPEN VALVE	Digital input ¹⁾	<p>This function will open the valve. Valve will be in interlock mode as long as function is activated. After deactivation of function it will remain effective until converse RS232 control command have been received.</p> <p>The function is activated when optocoupler is 'on' in non inverted configuration.</p> <p>The function is activated when optocoupler is 'off' in inverted configuration.</p> <p>Configuration can be done in local operation via service port or in remote operation.</p>	2 ²⁾
23	DIGITAL GROUND	Digital ground	<p>Ground for all digital inputs. Ground is used when digital inputs are operated by switches. Connect switches to ground. See also in chapter «Schematics» configuration a).</p>	
25	DIGITAL COMMON	Digital common	<p>Common for all digital inputs. Common is used when digital inputs are driven by voltage sources. Connect + or – terminal of source with common (optocoupler inputs are capable of bidirectional operation). See also « Function and Wiring» configuration b).</p>	



The **digital inputs** on the **POWER and INTERFACE connector** have the **same priority**.

- 1) Highest priority is 1. Functions with lower priorities will not be effective as long as higher priority functions are active. These digital inputs have higher priority than all RS232 commands. RS232 commands will not be accepted while digital inputs are active.

4.3.3.6 Digital output

Pin	Function	Signal type	Description
9	VALVE CLOSED	Digital output	This function will indicate that the valve is closed. If the function "ON" is configured the output is continuous on. Configuration can be done in local operation via service port or in remote operation.
8	VALVE OPENED	Digital output	This function will indicate that the valve is open. If the function "ON" is configured the output is continuous on. Configuration can be done in local operation via service port or in remote operation.
7	DIGITAL GROUND	Digital common	Common for all digital output. Connect + or – terminal of source with common

4.3.3.7 Analogue output

Pin	Function	Signal type	Description
22	PRESSURE	Analog output	This output indicates the current pressure as 0-10V. The output voltage is in linear relation to the pressure. Depending on the selected SETPOINT RANGE 10V means either sensor full scale or 10% of sensor full scale. In case of 2 sensor operation sensor full scale relates to sensor 1 (high range).
21	POSITION	Analog output	This output indicates the current valve position as 0-10V voltage range. The voltage is in linear relation to the valve position. 0V is closed but not isolation function and 10V is open position. (Use digital output for isolation function)
20	ANALOG GROUND	Analog common	Common for analog outputs.

4.3.4 RS232 interface connection

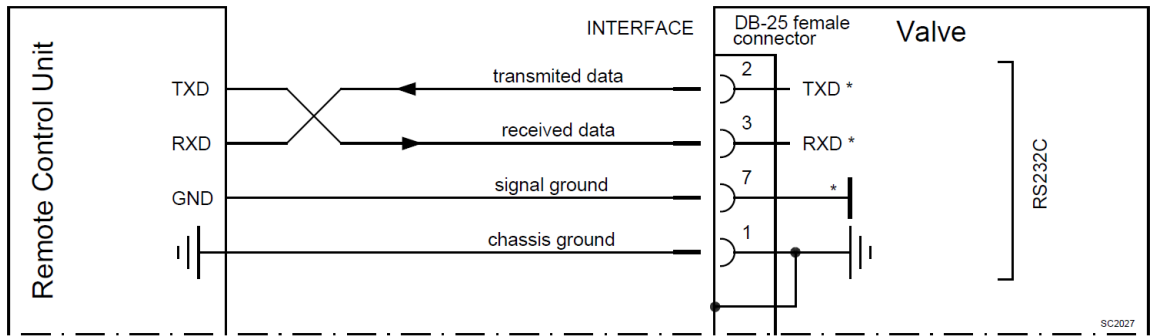

Do not connect other pins than indicated in the schematics above!
Use only screws with 4-40UNC thread for fastening the DB-25 connector!

4.3.5 Service port connection

The service port (connector: SERVICE, USB - B) allows to connect the valve to a USB - A port of a computer. This requires a USB A-B cable male-male. The 'Service port is used for 'Local operation'.

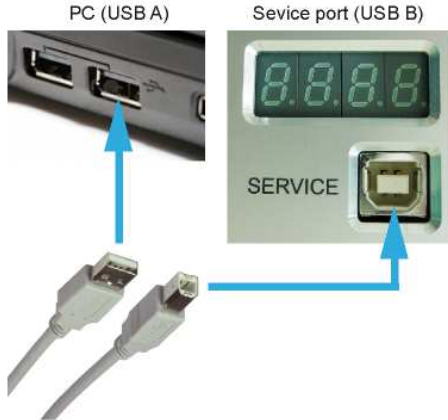

You can use our Software 'Control Performance Analyzer' 4.0 for Local operation, which is integrated in the IC2 controller. Refer to chapter: 'Local operation' for detail information.

4.4 Initial operation



To enable the valve cluster for **pressure control** setup **steps 1 to 7 must be performed**. In case position control is required only it's sufficient to perform steps 1 to 4.

Setup step		Description
1	Power up	Turn on external + 24VDC power supply (and external ± 15 VDC for sensor power supply if required).
2	Scaling of Pressure and Position Values	Refer to chapter «Scaling of Pressure and Position Values» for details.
3	Valve configuration	Refer to chapter «Valve configuration» for details.
4	Interface configuration	Refer to chapter «RS232 interface configuration» for details.
5	Sensor configuration	Basic configurations of the valve must be adapted according to application needs. Refer to chapter «Sensor configuration» for details.
6	Zero Adjust	Compensation of the sensor offset voltage. Refer to chapter «Sensor configuration» for details.
7a	Learn	<i>For adaptive pressure controller only.</i> Determination of the vacuum system characteristic to accommodate the PID controller. Refer to chapter «LEARN adaptive» for details.
7b	Pressure Control Configuration	Adaption of pressure controller to the vacuum system characteristic. Refer to chapter: «Pressure Control» for details.



Without «LEARN» or «PRESSURE CONTROL COFIGURATION» the valve is not able to run pressure control.

4.5 Scaling of Pressure and Position Values

The scaling for pressure and position values can be configured.

- The position scaler defines the unit/range of all position values: Target Position, Actual Position, ...
- The pressure scaler defines the unit/range of all pressure values: Target Pressure, Actual Pressure, ...

Overall there are six individual scalers:

RS232	Position Scaler
	Pressure Scaler
	Position Scaler
	Pressure Scaler

Service (CPA over USB)

Parameter location RS232 scaler

CPA	RS232
Interface RS->Scaling	Refer to RS232-setup command for detail

Parameter location Service (CPA over USB) scaler

	<p>EtherCAT -(no access)</p>
--	---

4.6 Valve configuration

Basic valve configuration must be adapted according to application needs.
 Definition of valve plate position in case of:

- **After power up**, default is 'close'.
- **Power failure**, default is 'not defined'. Only for versions that have Power Fail Option equipped [653 . . . C or 653 H].
- **Network failure**, for default settings refer to individual product data sheet.

Local operation: (‘Control View’, ‘Control Performance Analyzer’)	Remote operation: (Refer to chapter «Setup commands» for details)
With CPA: <ul style="list-style-type: none"> • Do valve configuration in menu ‘Valve / Setup’. 	1. Send VALVE CONFIGURATION

4.6.1 Homing Start Option

Homing start option defines when the valve performs the homing procedure.

Parameter	Description
Start Condition	Homing start option defines when the valve performs the homing procedure. Standard Do homing after restart if valve is not in sealed state Open Command Do homing on an open command Move Command Do homing on any move command At Startup Do homing after restart Homing Command Do homing on homing command Move Command/Standard Settings from move commands, without homing in close position by close command
End Control Mode	This control mode is set after a successful homing.
End Position	In case the “End Control Mode” is set to “Position”, this parameter defines which position is set after successful homing.

Parameter location:

CPA	RS232
Valve->Homing	Refer to RS232-setup command for detail

4.6.2 Power Failure Option

These settings define what the valve is doing in case the power fails.

Parameter	Description
Enable	‘True’ enables the power fail reaction, in case of ‘False’ there is no reaction on a power fail
State	Current power fail state
Functionality	Defines the functionality in case of power fails. This can be “open” or

	“close”.
Delay	After this delay the power failure reaction starts after the power failed

Parameter location:

CPA	RS232
Power Fail Option	Refer to RS232-setup command for detail

4.6.3 Digital I/O

On the power connector there are two digital inputs and two digital outputs available. See chapter «Power and sensor connection» to get more information about the pinning.

Each of the four IO (2 inputs and 2 outputs) has following parameters:

Parameter	Description
Enable	‘True’ enables the input or output
State	Current state of the input or output
Functionality	Defines the functionality of the input or output
Inverted	‘True’ inverts the input or output. In case of an input, an inversion means that a ‘0’ activate (State gets 1) the functionality and a ‘1’ means not activated (State gets 0)

Parameter location:

CPA	RS232
Power Connector IO	Refer to RS232-setup command for detail

4.7 RS232 Interface configuration

4.7.1 RS232 interface configuration

The factory default configuration of the RS232 interface might be changed to fit the application by using the CPA4.0 SW.

Baud rate	Data bits	Stop bits	Parity
115200	8	1	non

<p>Local operation: with 'Control Performance Analyzer' 4.0, refer to chapter: «Local operation»</p> <ol style="list-style-type: none"> 1. Open the CPA 4.0 2. Click [Local] 3. Click [Valve] > [Parameters] 4. Click [Interface RS232/RS485] 5. Select the 'Operation Mode' 6. Do the 'COM Settings' 7. Do the 'Input/Output' settings 8. For saving the settings Click [Save] 	<p>Remote operation:</p> <p>Refer to "RS232 setup commands" for details.</p>
---	---

4.8 Sensor configuration

4.8.1 Sensor configuration

It's important to do proper sensor configuration. The valve internally calculates in absolute values, so the valve has to know what sensors are connected.

Parameter	Description
Available	Set to 'True' if a sensor is connected
Enable	Set to 'True' if the sensor signal is used for pressure control
Range.Data Unit	Set the pressure data unit of the gauge
Range.Upper Limit Data Value Range.Lower Limit Data Value	Set the upper limit and lower limit of the gauge in the unit of "Range.Data Unit" Example for a 250mTorr linear sensor: Upper Limit = 250.0 Lower Limit = 0.0
Range.Upper Limit Voltage Value Range.Lower Limit Voltage Value	These parameters are only used for gauges with analog voltage interface. The values corresponds to Range.Upper Limit Data Value and Range Lower Limit Data Value Example: Upper Limit: 10.0V → 250mTorr Range Upper Limit Data Value Lower Limit: 0.0V → 0.0mTorr Range Lower Limit Data Value
Range.Scale	Select if a 'Linear' or a 'Logarithmic' type of gauge is used. Most gauges are linear type gauges.
Input Source	Select 'Analog' if a gauge with analog voltage interface is used. Select 'Digital' if an RS232 gauge is used.

“Sensor Crossover” defines the behavior when the actual pressure is around the upper limit of the low range sensor and define what sensor signal is used for building the Actual Pressure.

Parameter	Description
Crossover Mode	<p>Execution method of the transient area from one sensor to the other:</p> <p>0: Soft Switch Actual Pressure is a summation of the pressure value of sensor 1 and sensor 2.</p> <p>1: Hard Switch Actual Pressure is the value of sensor 1 or sensor 2</p> <p>2: Target Pressure During pressure control: If Target Pressure falls into low range sensor, the low sensor is used for Actual Pressure. In other case the high range sensor is used. During position control: ‘Soft Switch’ is used.</p>
Threshold High [SFS low sensor] Threshold Low [SFS low sensor]	<p>Defines the crossover area in Crossover Mode ‘Soft Switch’ and ‘Hard Switch’.</p> <p>Example: Threshold High = 1.0 [SFS of low sensor] Threshold Low = 0.9 [SFS of low sensor]</p> <p><u>Soft switch:</u> At pressure $\leq 0.9 \cdot \text{SFS low sensor}$: Actual Pressure = Sensor low pressure At pressure $0.95 \cdot \text{SFS low sensor}$: Actual Pressure = 50% * Sensor low pressure + 50% sensor high pressure At pressure $\geq 1.0 \cdot \text{SFS low sensor}$: Actual Pressure = Sensor high pressure</p> <p><u>Hard switch:</u> At pressure increase over $1.0 \cdot \text{SFS low sensor}$: Actual Pressure = Sensor high pressure after Delay At pressure decrease under $0.9 \cdot \text{SFS low sensor}$: Actual Pressure = Sensor low pressure after Delay</p>
Delay	Switch over delay in Crossover Mode ‘Hard Switch’, see example above.

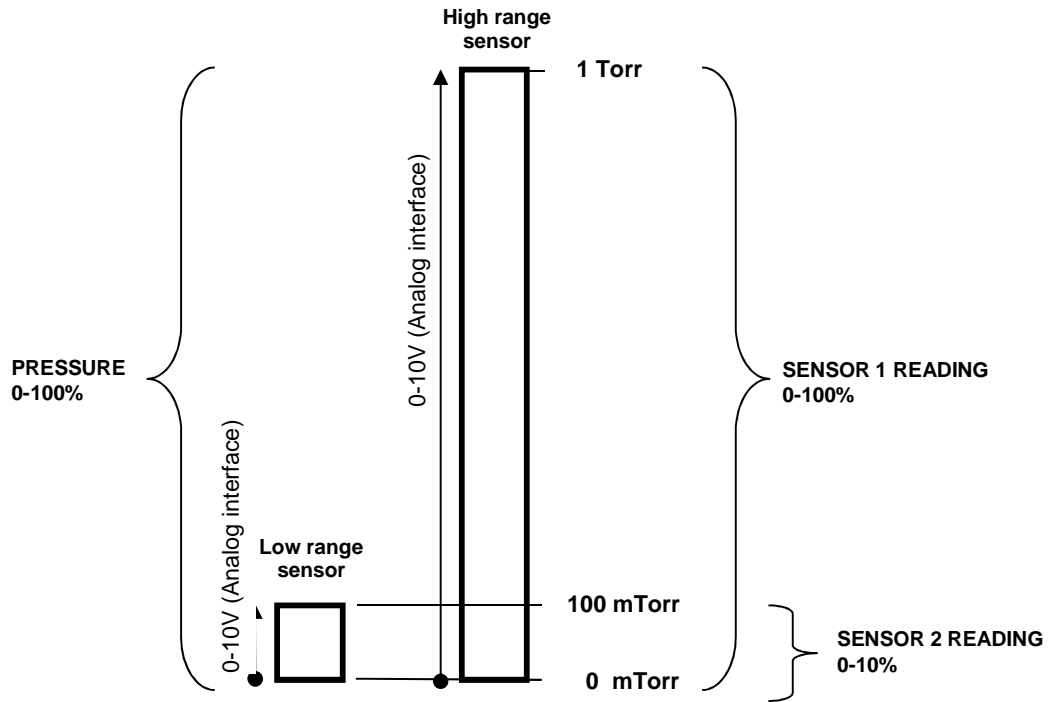

Analog sensors:

<p> Sensor 1.Available = 1 Sensor 1.Enable = 1 Sensor 1.Range.Data Unit = Torr Sensor 1.Range.Upper Limit Data Value = 1.0 Sensor 1.Range.Lower Limit Data Value = 0.0 Sensor 1.Range.Upper Limit Voltage Value = 10.0 Sensor 1.Range.Lower Limit Voltage Value = 0.0 Sensor 1.Range.Scale = Linear Sensor 1.Input Source = Analog </p>	<p> Sensor 2.Available = 1 Sensor 2.Enable = 1 Sensor 2.Range.Data Unit = mTorr Sensor 2.Range.Upper Limit Data Value = 100.0 Sensor 2.Range.Lower Limit Data Value = 0.0 Sensor 2.Range.Upper Limit Voltage Value = 10.0 Sensor 2.Range.Lower Limit Voltage Value = 0.0 Sensor 2.Range.Scale = Linear Sensor 2.Input Source = Analog </p>
--	---

4.8.2 Zero Adjust

Zero Adjust allows for the compensation of the sensor offset voltage.

When Zero Adjust is performed the current value at the sensor input is equated to Zero.Adjust Target Pressure.

In case of a 2 sensor system both sensor inputs will be adjusted.

Note: A maximum offset voltage of +/- 1.4 V can be compensated.

To execute a zero adjust, the zero adjust have to be enabled (see chapter above).

Parameter	Description
Zero Adjust.Sensor Selection	Select the sensor for the zero adjust: <ul style="list-style-type: none"> • Sensor 1 + 2 • Sensor 1 • Sensor 2
Zero Adjust.Target Pressure	Normally this parameter is set to 0 in case the process chamber is fully evacuated (which means pressure value is nearly 0). If not you can align the sensor value to a known pressure. In this case set Target Pressure to the current pressure. Note: Target Pressure is in the unit of pressure, see chapter «Scaling of Pressure and Position Values»
Zero Adjust.Execute	Start the zero adjust by set Execute to 1 At this moment offset value will be calculated and Sensor x.Value = Target Pressure. The resulting offset value can be read on parameter Sensor x.Offset Value [SFS] Clear the offset values by setting Execute to 2 The result of clearing the zero adjust: Sensor x.Offset Value [SFS] = 0.0
Sensor 1.Enable Sensor 2.Enable	0: It's not possible to execute a zero adjust. A present offset value is ignored. 1: It's possible to execute a zero adjust. A present offset value is respected.
Sensor 1.Offset Value [SFS] Sensor 2.Offset Value [SFS]	Value which will be subtracted from measured sensor value The value is related to sensor full scale (0.1 means 10% of sensor full scale)

Parameter location:

CPA	RS232
Pressure Sensor->Zero Adjust Pressure Sensor->Sensor 1->Zero Adjust Pressure Sensor->Sensor 2->Zero Adjust Pressure Sensor->Sensor 1->Zero Adjust Pressure Sensor->Sensor 2->Zero Adjust	Refer to "RS232 setup commands" for details.

Performing a zero adjust:

1. Wait until process chamber is evacuated and sensor signal is not shifting anymore. Do not perform Zero Adjust as long as pressure gauge voltage is shifting otherwise incorrect pressure reading is the result. Refer to manual of sensor manufacturer for warm up time.
2. Set parameter Sensor Selection
3. Set parameter Target Pressure (Zero Adjust->Target Pressure, not the Target Pressure for pressure control)
4. Set parameter Execute = 1
5. Check parameter Actual Pressure if the pressure is shifted as expected

For RS232 it's also possible to execute the zero adjust with the object «GENERAL CONTROL SETPOINT» of the PDO communication. In both case (perform the zero adjust **with Sensor Selection, Execute and Execute or GENERAL CONTROL SETPOINT**) the result is the same:

1. Wait until process chamber is evacuated and sensor signal is not shifting anymore. Do not perform Zero Adjust as long as pressure gauge voltage is shifting otherwise incorrect pressure reading is the result. Refer to manual of sensor manufacturer for warm up time.
2. In «OUTPUT Buffer» > «GENERAL CONTROL SETPOINT» set Bit 0 (rising etch).
3. Wait until Bit1 of «GENERAL STATUS» is set (see INPUT Buffer).



Do not perform Zero Adjust, if the base pressure of your vacuum system is higher than 1‰ of sensor full scale. We recommend disabling Zero Adjust function or using of Zero Adjust.Target Pressure other than 0.0 in this case. Otherwise incorrect pressure reading is the result.

4.9 Learn (adaptive control algorithm)

LEARN adapts the PID controller of the valve to the vacuum system and its operating conditions. LEARN must be executed only once during system setup. The LEARN routine determines the characteristic of the vacuum system. Based on this, the PID controller is able to run fast and accurate pressure control cycles. This characteristic depends on various parameters such as chamber volume, conductance and flow regime. Therefore it must be performed with a specific gas flow according to instruction below. The result of LEARN is a pressure versus valve position data table. This table is used to adapt the PID parameters. The data table is stored in the device memory which is power fail save. The data table can be up-/downloaded via 'Control Performance Analyzer' software or remote interface. Due to encoding the data may not be interpreted directly. By an OPEN VALVE, CLOSE VALVE, POSITION CONTROL or PRESSURE CONTROL command the routine will be interrupted.

Parameter	Description
Bank Selection	Select one of four learn bank to place the result of the learn procedure. Important: It's important that after the learn pressure controller select this learn bank!
Pressure Limit [SFS]	Set learn limit pressure (to which pressure the learn shall be executed). The value is related to the sensor full scale of high sensor. 1.0 means the whole pressure range of the sensors
Open Speed	Define the speed for opening the valve during the learn procedure. 1.0 means full speed
Status	State of the current learn 0: Not Started 1: In Progress 2: Completed Successfully 3: Aborted 4: Failed
Warning Info	Warning of current learn procedure: Bit 0: Learn is running Bit 1: Checksum error (learn data corrupt) Bit 2: Learn procedure terminated by user Bit 3: Pressure at position open > 50% of pressure limit Bit 4: Pressure at minimal conductance position < 10 % of pressure limit Bit 5: Pressure falls while move valve in direction of close Bit 6: Pressure at open position does not match pressure of previous open Bit 7: Learn procedure terminated by program Bit 8: Pressure <= 0 at open position (no gas flow set?)

Parameter location:

CPA	RS232
Pressure Control->Adaptive Learn	Refer to "RS232 setup commands" for details.

Execute a learn procedure:

1. Set specific gas flow according to calculation below and wait until flow is stable. Learn does not need to be performed with the process gas. Instead N₂ or Ar may be used.
2. Set parameter **Bank Selection**, if only one learn is used take Bank 1. Be sure that the pressure controller also selects this learn bank!
3. Set parameter **Open Speed**. If it's critical for the chamber, if the pressure falls rapidly while opening the valve, reduce the open speed.
4. Set parameter **Controller Mode = LEARN**.
5. Wait till **Controller Mode** leave to **LEARN** state → Learn procedure is finished
6. Check if the learn was successful by checking if **Status** shows value 2 (=Completed Successfully). In best case **Warning Info** shows no warning.



Sensor signal must not shift during LEARN. Wait until sensor signal is stable before LEARN is performed. Learn may take several minutes. Do not interrupt the routine as a single full run is required to ensure fast and accurate pressure control. The PID controller covers 5% to 5000% of the gas flow which was used for learn.

Gasflow calculation for LEARN:



Do not apply a different gasflow for learn than determined below. Otherwise pressure control performance may be insufficient.

Required pressure / flow regime must be known to calculate the most suitable learn gas flow for a specific application.

- At first it is necessary to find out about the required control range respectively its conductance values. Each working point (pressure / flow) must be calculated with one following formulas. Choose the applicable formula depending on units you are familiar with.

$$C_{WP} = \frac{1000 \cdot q_{WP}}{p_{WP}}$$

C_{WP} required conductance of working point [l/s]
 q_{WP} **gasflow** of working point [Pa m³/s]
 p_{WP} **pressure** of working point [Pa]

$$C_{WP} = \frac{q_{WP}}{p_{WP}}$$

C_{WP} required conductance of working point [l/s]
 q_{WP} **gasflow** of working point [mbar l/s]
 p_{WP} **pressure** of working point [mbar]

$$C_{WP} = \frac{q_{WP}}{78.7 \cdot p_{WP}}$$

C_{WP} required conductance of working point [l/s]
 q_{WP} **gasflow** of working point [sccm]
 p_{WP} **pressure** of working point [Torr]

- Out of these calculated conductance values choose the lowest.

$$C_R = \min(C_{WP1}, C_{WP2}, \dots, C_{WPn})$$

C_R required lower conductance [l/s]
 C_{WPx} required conductance of working points [l/s]



To make sure that the valve is capable to control the most extreme working point verify that $C_R \geq C_{min}$ of the valve (refer to «Technical data»).

- Calculate gasflow for learn. Choose the applicable formula depending on units you are familiar with.

$$q_L = \frac{p_{SFS} \cdot C_{min}}{1100}$$

q_L gasflow for learn [Pa m³/s]
 p_{SFS} sensor full scale pressure [Pa]
 C_{min} min. controllable conductance of valve [l/s], (refer to «Technical data»)

$$q_L = \frac{p_{SFS} \cdot C_{min}}{1.1}$$

q_L gasflow for learn [mbar l/s]
 p_{SFS} sensor full scale pressure [mbar]
 C_{min} min. controllable conductance of valve [l/s], (refer to «Technical data»)

$$q_L = 71 \cdot p_{SFS} \cdot C_{min}$$

q_L gasflow for learn [sccm]
 p_{SFS} sensor full scale pressure [Torr]
 C_{min} min. controllable conductance of valve [l/s], (refer to «Technical data»)

4.10 Pressure Control

The valve has four identical pressure controller units. **Controller Selector** defines which unit is used for the pressure control.

Most applications do not need more than one controller units. But if the result of the pressure control does not meet the expectations, the different controller units can be an option for optimization: With the four controller units it's possible to use an own controller unit for a specific pressure working point. This controller unit can be parametrized optimally for this specific working point.

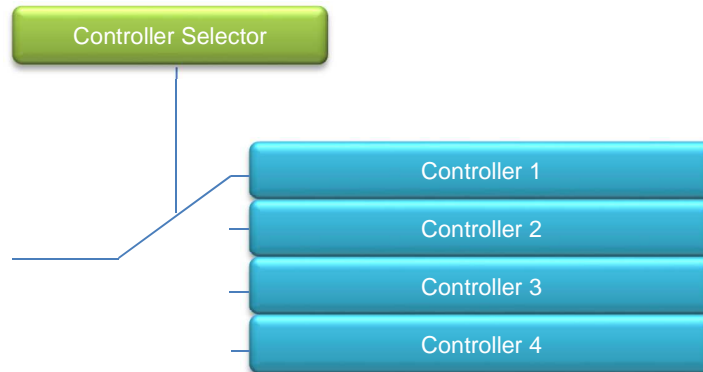

Figure 1: The Controller Selector selects the controller.

4.10.1 Pressure control operation with 2 sensors

If 2 sensor operation is enabled, changeover between the sensors is done automatically during pressure control. For configuration refer to chapter «Setup procedure». We recommend a ratio of 10:1 between the pressure gauges. Max. ratio is 100:1. High range respectively low range pressure gauge may be either connected to sensor 1 or sensor 2 input. It's required to do correct sensor configuration.

Between 90 and 100% of the low range sensor full scale, the low range sensor is phased out while high range sensor is phased in during pressure rise. During pressure decrease the high range sensor is phased out while low range sensor is phased in. This maintains a functional response behavior in case of small calibration errors between the two sensors. The PRESSURE output in this range is a blend between both sensors.

For monitoring purpose each sensor signal may be read out individually. Refer to «inquiry commands SENSOR 1 READING and SENSOR 2 READING»



Make sure that both sensors are calibrated. Do not close optional gauge isolation valves during the transition phase between the sensors.

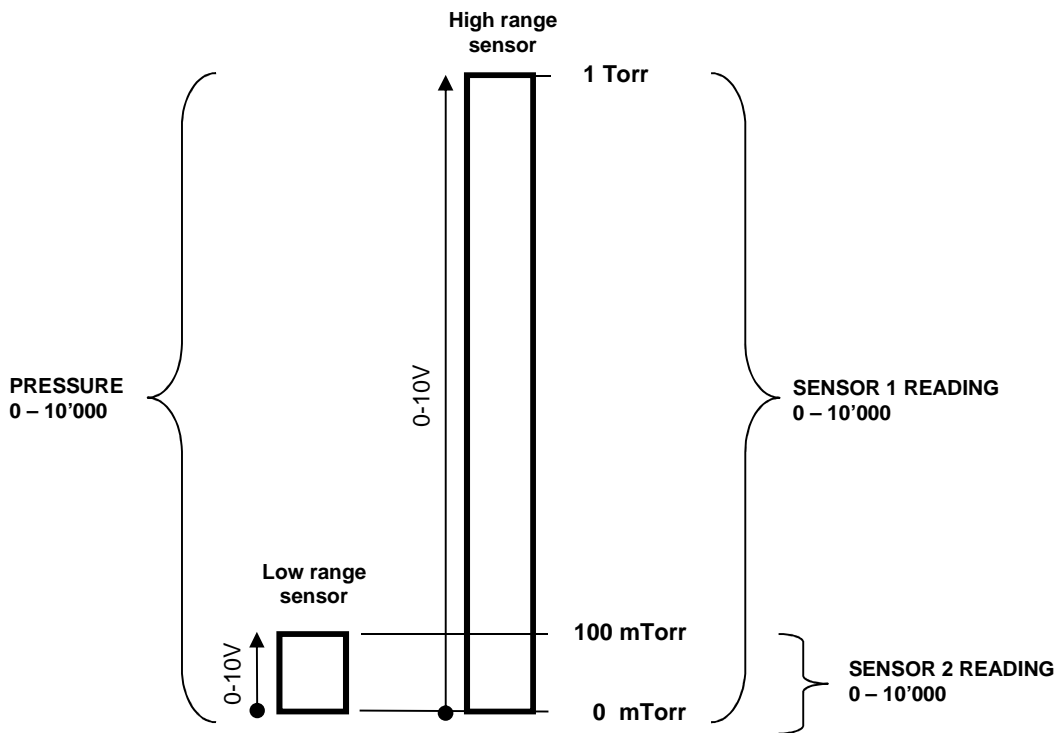

4.10.2 Control parameters

This chapter describes the functionality of Controller 1 to Controller 4.

4.10.2.1 Control algorithm

Parameter location:

CPA	RS232
Pressure Control Pressure Control->Pressure Controller 1 Pressure Control->Pressure Controller 2 Pressure Control->Pressure Controller 3 Pressure Control->Pressure Controller 4	See command list - s:02

The main parameter of a controller unit is its **Control Algorithm**. There are different control algorithms implemented in the firmware of the valve. The user can select the control algorithm which fits his demands.

Control Algorithm	Description
<i>Adaptive</i>	This is the most dynamic control algorithm. Before using adaptive control algorithm, a special procedure called "learn" must be executed first (see chapter x). The valve will observe the behavior of the vacuum system by moving the valve to different positions. During the learn procedure the valve performs an internal parameter estimation correspondent to the vacuum system. Note: The adaptive pressure control work at its best if the conditions (mainly gas flow) are close the conditions at the learn procedure.
<i>PI</i>	This is a solid algorithm for pressure control. The performance will be behind the adaptive control algorithm. But if the condition varies a lot, it's possible that the adaptive control algorithm does not work properly so the PI algorithm provides the best result.
<i>Soft Pump</i>	Is a modified PI control algorithm to pump down from atmospheric pressure. This control algorithm has been optimized to prevent that the pressure in the chamber is falling too fast (reduce occurrence of undershoots).

4.10.2.2 Control parameter

Depending on the Control Algorithm setting there are different parameters available to adjust the algorithm:

	Parameter	Description
Adaptive	Gain Factor	<i>The Gain Factor is a control parameter to adapt the performance of the pressure control algorithm. A higher gain results in a faster response, higher over- / undershoots of pressure. A lower gain results in slower response, lower over- / undershoot of pressure.</i>
	Sensor Delay	<i>The Sensor Delay is a control parameter to compensate delays during the pressure detection. Pipes and orifices for sensor attachment can cause delays in response time and could impact badly the pressure control stability. By adapting this parameter to the approximate delay time stability problems can be reduced. But control response time will be slowed down by this measure.</i>
	Learn Data Selection	<i>There are up to 4 different learn data sets available. Select which Learn Data set the adaptive controller shall use for pressure control.</i>
PI	P-Gain	<i>The P-Gain is the proportional factor of the fixed control algorithm. A higher P-Gain results in faster response, higher over- / undershoot of pressure.</i>
	I-Gain	<i>The I-Gain is the integral factor. The I-Gain helps to reach the target pressure exactly.</i>
	Direction	<i>The Control Direction defines the type of application, if the valve is mounted in downstream or upstream. Downstream means the valve is after the chamber and before the pump. Upstream, valve is mounted before chamber and pump.</i>
Soft Pump	P-Gain	<i>The P-Gain is the proportional factor of the fixed control algorithm. A higher P-Gain results in faster response, higher over- / undershoots of pressure.</i>
	I-Gain	<i>The I-Gain is the integral factor. The I-Gain helps to reach the target pressure exactly.</i>

4.10.2.3 Pressure ramp

Basically, the pressure ramp is used to limit the rate of pressure change. It can also be used to minimize over- / undershoot of pressure.

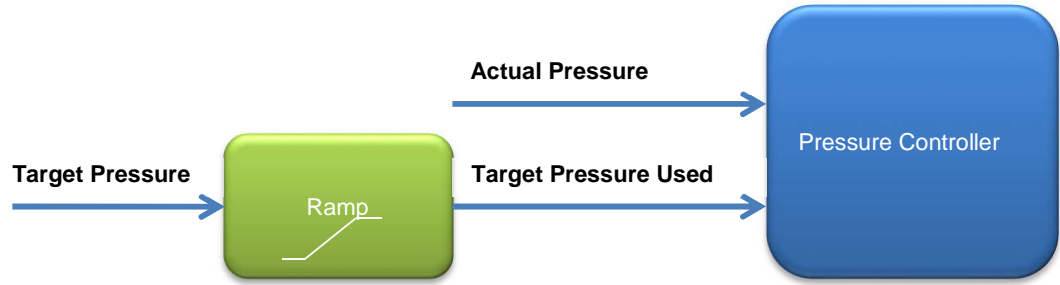

New Target Pressure without pressure ramp

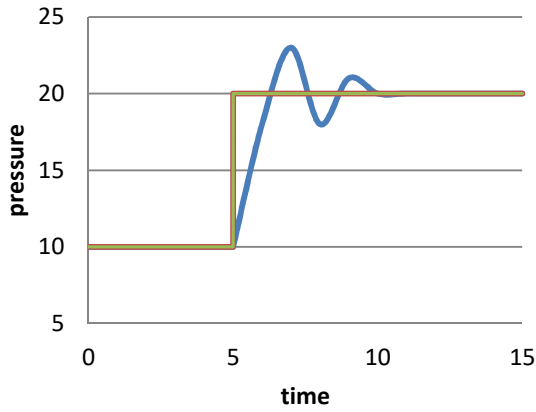

- Actual Pressure
- Target Pressure
- Target Pressure Used (ramp)

New Target Pressure with pressure ramp

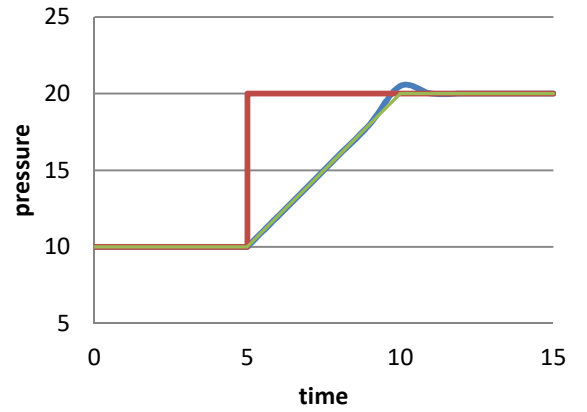

- Actual Pressure
- Target Pressure
- Target Pressure Used (ramp)

4.10.2.4 Pressure ramp configuration

Time Mode (Ramp Mode = Time)

The time within **Target Pressure Used** (ramp) reaches a new **Target Pressure** is defined in parameter value **Ramp Time**. **Ramp Time** is a value in the unit [seconds].

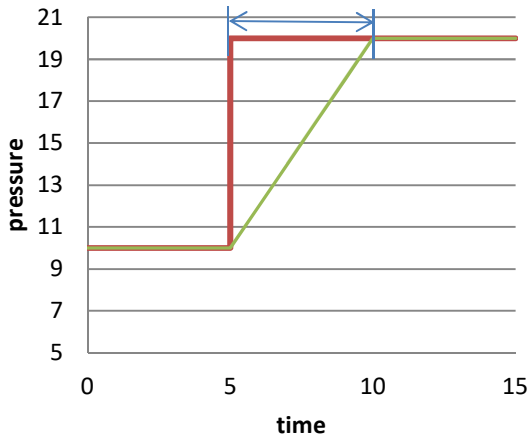

— Target Pressure
— Target Pressure Used (ramp)

Slope Mode (Ramp Mode = Slope)

After setting a new **Target Pressure**, **Target Pressure Used** will converge the **Target Pressure** in the slope defines in parameter **Ramp Slope**. **Ramp Slope** is a value in the unit [pressure / seconds]

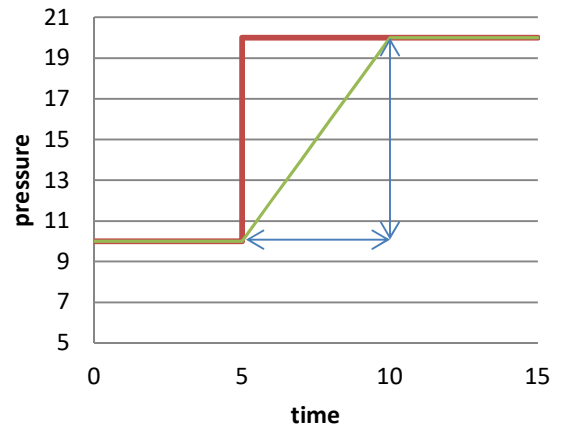

— Target Pressure
— Target Pressure Used (ramp)

4.10.3 Choose correct control algorithm

Select the configuration what your application needs.

System Configuration	Constant gas flow available		Constant gas flow not available
	Tv* <= 500 sec	Tv* > 500 sec	
<p>Downstream</p>	<p>Adaptive pressure controller</p>	<p>Fixed pressure controller</p>	
<p>Upstream</p>	<p>Fixed pressure controller</p>		
<p>Soft Pump</p>	<p>Soft Pump</p>		



Use the formula below to define the applicable pressure control algorithm.

$$T_v = \frac{p_{SFS} \cdot CV}{q_L}$$

- q_L** gasflow for learn [mbar/s]
- p_{SFS}** sensor full scale pressure [mbar]
- T_v*** Vacuum time constant [sec]
- CV** Chamber Volume [l]

4.10.4 Tuning of control performance

- Tuning of pressure control performance with adaptive control, refer to chapter: Tuning of control performance with adaptive pressure controller
- Tuning of pressure control performance with PI control, refer to chapter: Tuning of control performance with fixed PI pressure controller
- Tuning of control pressure performance with Soft pump , refer to chapter: Tuning of control performance with soft pump pressure controller

4.10.4.1 Tuning of control performance with adaptive pressure controller

Normally the default settings will result in good pressure control performance. For some applications tuning may be required to improve performance. The tuning procedures for each parameter (grey boxes) and its default values are described separately below. Strictly keep the procedure order.

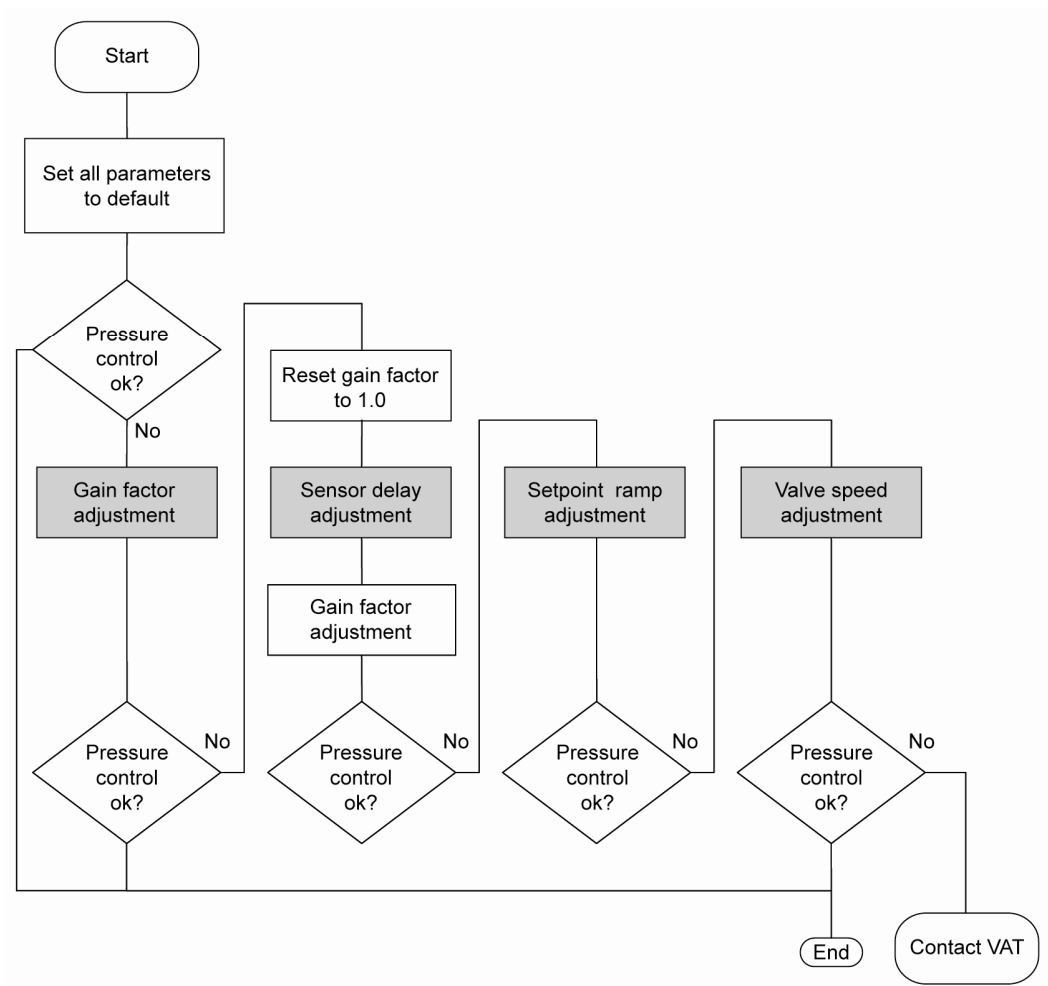

Gain factor adjustment

The gain factor effects: **Stability, Response time**

Adjustment range is from 0.0001 to 7.5.

- Higher gain results in: faster response / higher over- / undershoot of pressure
- Lower gain results in: slower response/ lower over- / undershoot of pressure

Adjustment procedure:

1. Start with gain factor 1.0
2. Open valve.
3. Control a typical pressure / flow situation.
4. Repeat from step 2 with lower (higher) gain factors until optimal pressure response is achieved and stability is ok.



Normally adjustments down to gain factors of 0.42 should lead to good results. Otherwise you may need to improve sensor connection. Refer to «Requirements to sensor connection».

Sensor delay adjustment

Sensor delay adjustment effects: **Stability**

Adjustment range is from 0 to 1.0s.

Pipes and orifices for sensor attachment delay response time and so badly impact pressure control stability.

By adapting this parameter to the approximate delay time stability problems can be reduced. But control response time will be slowed down by this measure.



Whenever possible sensors should be attached to the chamber according to «Requirements to sensor connection». This is the most effective measure against stability issues. If your gauge attachment fulfills these criteria do not use this parameter.

Adjustment procedure:

1. Start with gain factor 1.0 and sensor delay 0s.
2. Open valve.
3. Control a typical pressure / flow situation.
4. Repeat from step 2 with higher sensor delays until best possible stability is achieved.
5. Adjustment gain factor again. Refer to «Gain factor adjustment».

Setpoint ramp adjustment

Setpoint ramp effects: **Undershoot of pressure, Response time**

Adjustment range for Setpoint Ramp is from 0 to 10 s.

This parameter defines the time that is used to decrease / raise pressure between 2 setpoints. Especially in pressure decrease situations at low flows pressure response can be improved much by adapting setpoint ramp time.

Pressure chart

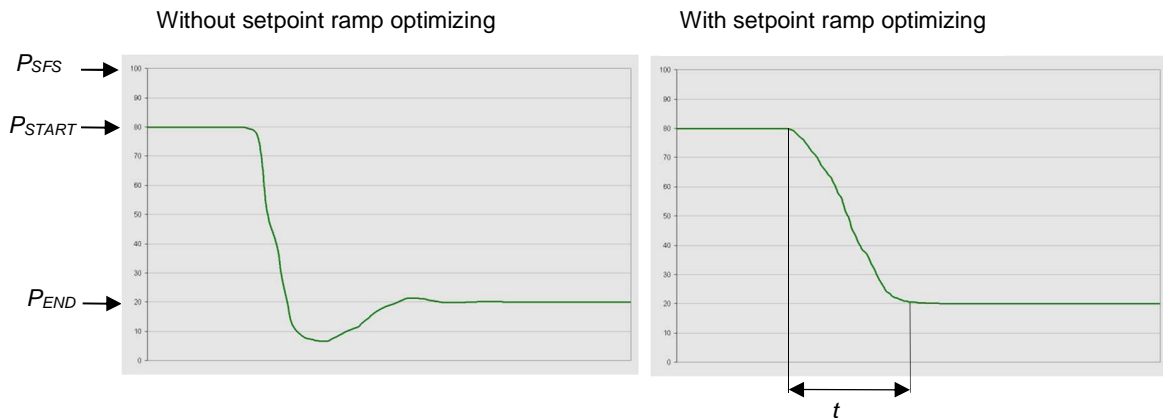

Choose the applicable formula depending on units you are familiar with.

$$t = \text{Setpoint Ramp}$$

Adjustment procedure:

1. Start with optimal gain factor and sensor delay time according to preceding tuning steps.
2. Control a typical pressure / flow situation.
3. Control a lower pressure.
4. Repeat from step 2 with longer setpoint ramps until best response is achieved.
5. Verify pressure control response for a setpoint raise situation.



In case a long ramp time is required to get optimal performance for pressure decrease situations it may be of advantage to apply different settings for decrease / raise control situations.

Valve speed adjustment

Valve speed effects: **Response time**

Default value is 1.0. Adjustment range is from 0.01 to 1.0.

This parameter effects valve plate actuating speed.
Speed adjustment is effective for PRESSURE CONTROL and POSITION CONTROL.



Normally best pressure control response is achieved with max. valve speed. In particular applications it may be of advantage to have a slower valve response. OPEN and CLOSE are always done with maximum speed.

Adjustment procedure:

1. Use optimal gain factor, sensor delay time and setpoint ramp according to preceding tuning steps.
2. Open valve.
3. Control a typical pressure / flow situation.
4. Repeat from step 2 with slower valve speed until required response is achieved.

Required information for support:

- Go to 'Tools / Create Diagnostic File' in 'Control Performance Analyzer' and save file
- Pressure / flow / gas conditions to be controlled
- Chamber volume
- Pumping speed (l/s) and pump type (e.g. turbo pump)
- System description
- Problem description

Send diagnostic file with and all required information to tuning-support@vat.ch

4.10.4.2 Tuning of control performance with fixed PI pressure controller

Optimizing P gain and I gain

This valve may be used for downstream or upstream pressure control depending on configuration. The PI parameters of the pressure controller require correct adjustment. These parameters must be set once during system setup and are stored in the device memory which is power fail save. Based on the PI controller configuration, the valve is able to run fast and accurate pressure control cycles. The PI parameters can be evaluated using below instruction.



- In downstream control mode valve will move towards open when current pressure is higher than set point.
- In upstream control mode valve will move towards close when current pressure is higher than set point.

Introduction

PI controller mode is used if for any reason (e.g. too long system time constant) the adaptive control mode does not provide satisfying control performance. In PI controller mode the parameters P gain and I gain have to be set according to the systems characteristics. The best set of parameters can be found by using the empiric method below.

1. Optimizing P gain and I gain

1.1 Pressure and gas flow for optimization

A PI controller delivers the best results for a certain working point (pressure/gas flow). If there is only one working point, this pressure and gas flow has to be used for optimizing P and I gain. If there are several working points that have to be covered, the pressure for optimizing is the medium pressure between highest and lowest pressure to be controlled, the gas flow for optimizing is the highest flow out of all working points.

Two different pressure set points are necessary for optimization. Set point 1 (SP1) is the pressure for optimizing as determined above. Set point 2 (SP2) is about 10 - 20% lower than SP1.

Example: pressure range: 4 – 10 Torr
Flow range: 2 – 4 slm

Pressure set points and gas flow for optimization:
SP1 = 7 Torr
SP2 = 6 Torr
Gas flow = 4 slm

1.2 Optimizing P gain

While optimizing P gain, the gas flow determined above has to be constant all the time.

Start optimization with P gain set to 1.0 and I gain set to 0.0.

Set chamber pressure to SP2, wait until the pressure is stable. Set pressure to SP1. If the transition from SP2 to SP1 results in a significant pressure over shoot or even does not stabilize at all, the P gain is too high. If there is no over shoot and the pressure reaches SP1 asymptotically and very slow, P gain is too low.

The optimal P gain value is found if the transition from SP2 to SP1 results in a slight pressure over shoot. It does not matter if there is still a deviation between SP1 and actual pressure.

Example:

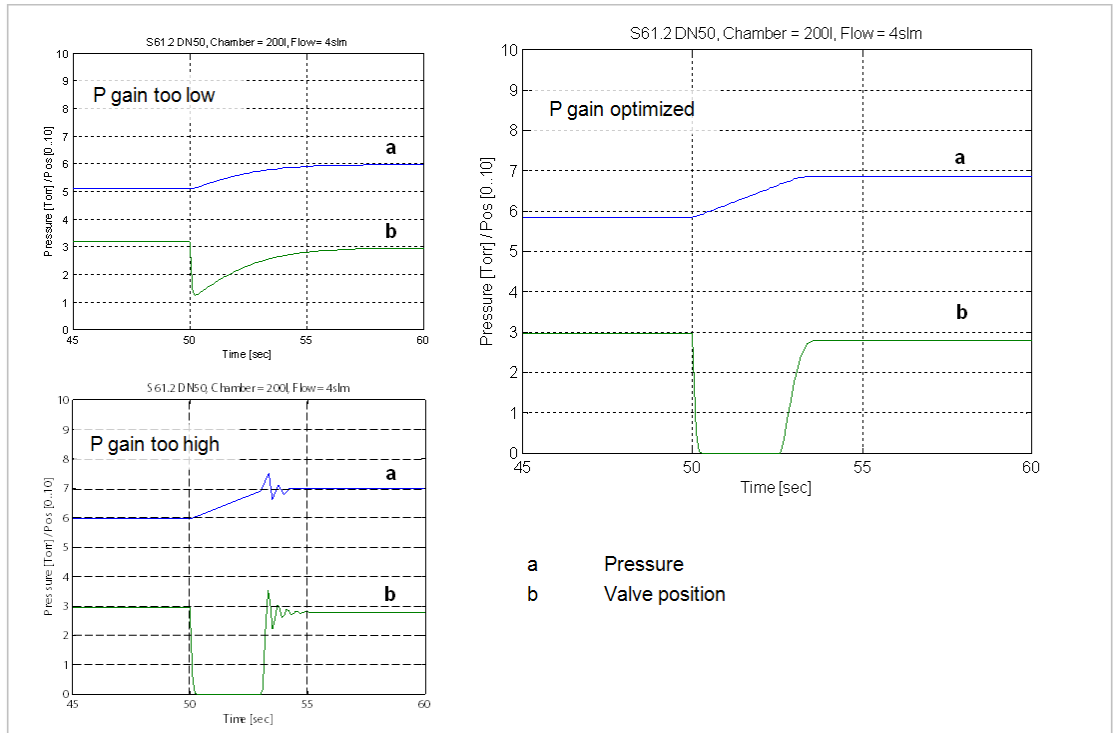

1.3 Optimizing I gain

While optimizing I gain, the gas flow determined above has to be constant all the time.

Start with P gain set to half of the value found when optimizing P gain and set I gain to 1.0. Keep the P gain constant.

Set chamber pressure to SP2, wait until the pressure is stable. Set pressure to SP1. If the transition from SP2 to SP1 results in a significant pressure over shoot or if the valve position does not stabilize, I gain is too high. If the transition results in a slow asymptotical pressure rise and there is still a constant deviation to SP2, the I gain is too low.

The optimal value for I gain is found if the transition from SP2 to SP1 result in just a slight pressure over shoot, a stable valve position and the actual pressure matches SP2 exactly.

Example:

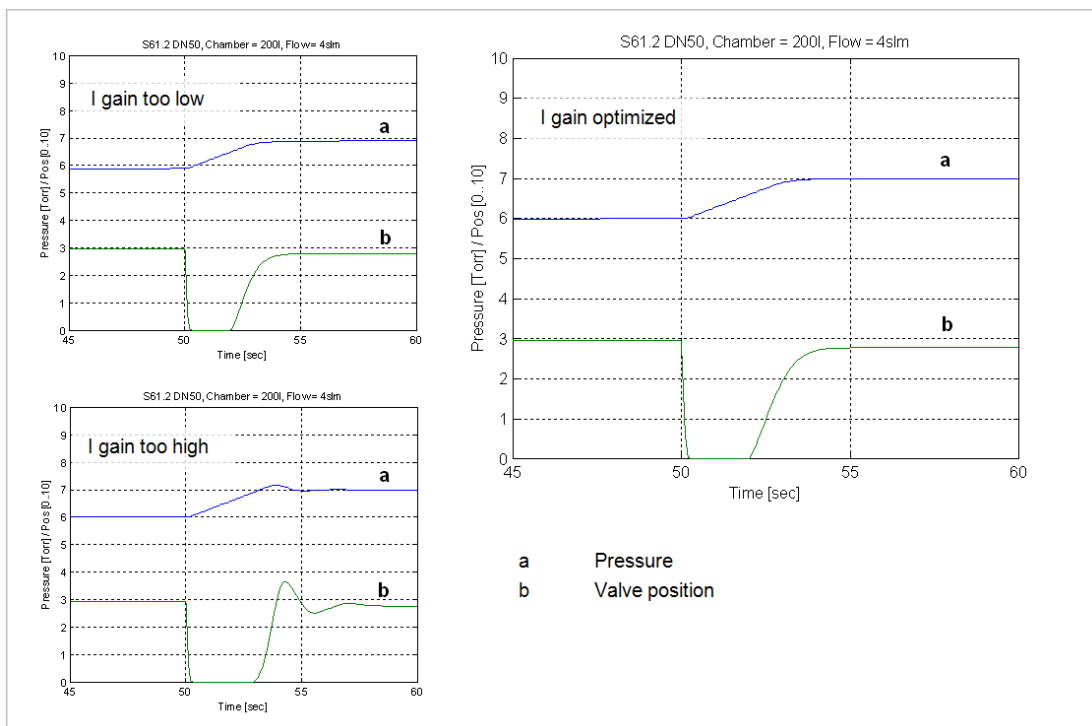

Check control performance over the whole control range with parameters above.

Required information for support:

- Go to 'Tools / Create Diagnostic File' in 'Control Performance Analyzer' and save file
- Pressure / flow / gas conditions to be controlled
- Chamber volume
- Pumping speed (l/s) and pump type (e.g. turbo pump)
- System description
- Problem description

Send diagnostic file with and all required information to tuning-support@vat.ch

4.10.4.3 Tuning of control performance with soft pump pressure controller

Optimizing P gain

This valve may be used to control pressure ramps during pump down. The P parameter of the pressure controller requires correct adjustment. This parameter must be set once during system setup and is stored in the device memory which is power fail save. Based on the soft pump controller configuration, the valve is able to run fast and accurate pressure control cycles. The P parameter can be evaluated using below instruction.

Introduction

Pump down control mode allows a completely user-defined pressure profile, usually from atmosphere down to some process pressure

1. Optimizing P gain

The P gain value evaluated for soft pump control mode might be different than the P gain value evaluated for PI controller mode. When switching to pump down control mode the P gain value evaluated for the PI controller has to be send to the valve controller. When switching back into PI controller mode the respective P gain value has to be send again. Adaptive pressure control mode ignores any P gain value.

1.1 Basic settings

The pump down characteristic is determined by start pressure, end pressure and pump down time. This straight line from start pressure to end pressure.

The VAT soft pump controller requires a pump down time shorter than 10 sec. for good control results. If the required pump down time is longer than 10 sec., the pump down curve has to be partitioned into sections shorter than 10 sec. with corresponding end pressure.

Example:

Start pressure:	760 Torr
End pressure:	10 Torr
Pump down time:	30 sec.

Here the pump down time and the corresponding pressure is being divided into three sections. The host sends a new pressure set point every 10 sec.:

Time	Set point
0 sec.	760 Torr
10 sec.	510 Torr
20 sec.	260 Torr
30 sec.	10 Torr

1.2 Optimizing P gain

WE start by setting the P gain to 1.0 as a trial value and adjust according to the response. The pump down routine has to be controlled as follows:

Move control valve into close position

Start pump down by opening the pump isolation valve or starting the pump and sending the first pressure set point to the valve controller. With the example above, the first pressure set point is 510 Torr.

At each new interval (exceeding 10 sec) send the new pressure set point.

Repeat until process pressure is achieved.

While pumping down chamber pressure and valve position should be data logged to compare the actual pump down curve with the ideal straight pump down line.

If the pressure follows the ideal pump down line with significant delay, the P gain is too low.

If the pressure oscillates around the ideal pump down line or if the valve position oscillates, P gain is too high.

P gain is optimized if the pressure follows the ideal pump down line closely and the valve position is not oscillating at all.

Example:

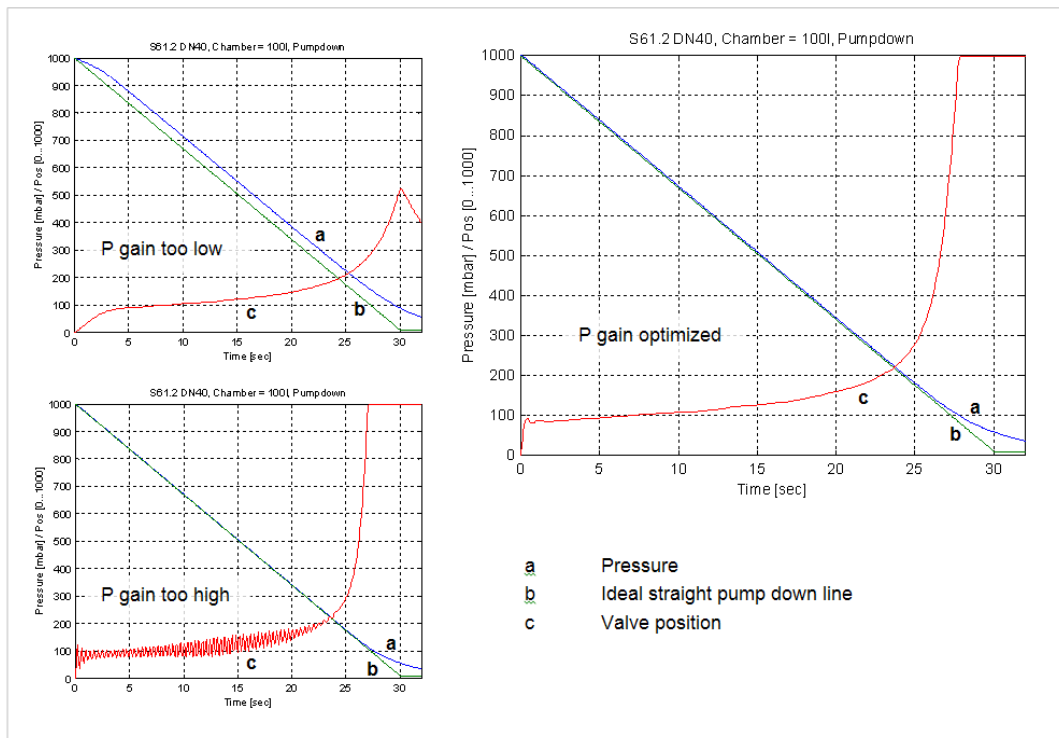

Required information for support:

- Go to 'Tools / Create Diagnostic File' in 'Control Performance Analyzer' and save file
- Pressure / flow / gas conditions to be controlled
- Chamber volume
- Pumping speed (l/s) and pump type (e.g. turbo pump)
- System description
- Problem description

Send diagnostic file with and all required information to tuning-support@vat.ch

4.11 RS232 interface commands (IC protocol)

4.11.1 RS232 command syntax

- Commands and values are case sensitive.
- Acknowledgement within 10ms after reception of command.
- Wait for acknowledgement before sending a new command.
- Command termination of each command is CR and LF.
CR = Carriage Return (0D hexadecimal), LF = Linefeed (0A hexadecimal)

4.11.2 Control commands

Control function	Command		Acknowledgement
	Description		
CLOSE VALVE	Set	C:	C:
	Valve will close.		
OPEN VALVE	Set	O:	O:
	Valve will open.		
HOLD	Set	H:	H:
	This function stops the valve at the current position. It is effective in PRESSURE CONTROL and POSITION CONTROL. The function can be revoked by a POSITION CONTROL, PRESSURE CONTROL, OPEN VALVE or CLOSE VALVE command.		
POSITION CONTROL	Set	R:aaaaaa	R:
	Get	i:38	i:38aaaaaaaa
	data length for Set 6 characters, for Get 8 characters aaaaaa position SETPOINT, value depends on configuration, refer to «Setup commands, COMMUNICATION RANGE» for details Change to POSITION CONTROL mode and transfer of position SETPOINT value resp. reading of position SETPOINT. Remark: Reading returns position setpoint only in case pressure control is not selected.		
PRESSURE CONTROL	Set	S:aaaaaaaa	S:
	Get	i:38	i:38aaaaaaaa
	data length 8 characters aaaaaaaaa pressure SETPOINT, value depends on configuration, refer to «Setup commands, COMMUNICATION RANGE» for details Change to PRESSURE CONTROL mode and transfer of pressure SETPOINT resp. reading of pressure SETPOINT. Remark: Reading returns pressure setpoint only in case pressure control is selected, otherwise position setpoint is returned.		

4.11.3 Inquiry commands

Inquiry function	Command		Acknowledgement
	Description		
POSITION	Get	A:	A:aaaaaa
	data length 6 characters aaaaaa position, return value depends on configuration, refer to «Setup commands, COMMUNICATION RANGE» for details This function returns the current valve position. Remark: 999'999 is returned when the position is unknown, for example after power up during synchronization		
PRESSURE	Get	P:	P:saaaaaaa
	data length 8 characters s sign, 0 for positive readings, - for negative readings aaaaaaa pressure, return value depends on configuration, refer to «Setup commands, COMMUNICATION RANGE» for details This function returns the actual pressure.		
SENSOR 1 OFFSET	Get	i:60	i:60aaaaaaaa
	data length 8 characters aaaaaaa sensor 1 offset (-140000 ... 0140000 = -1.4V ... +1.4V) This function returns the sensor 1 offset voltage (adjusted by ZERO).		
SENSOR 2 OFFSET	Get	i:61	i:61aaaaaaaa
	data length: 8 characters aaaaaaa sensor 2 offset (-140000 ... 0140000 = -1.4V ... +1.4V) This function returns the sensor 2 offset voltage (adjusted by ZERO).		
SENSOR 1 READING	Get	i:64	i:64saaaaaaa
	data length 8 characters s sign, 0 for positive readings, - for negative readings aaaaaaa sensor 1 reading, return value depends on configuration, refer to «Setup commands, COMMUNICATION RANGE» for details This function returns direct reading from sensor 1 input.		
SENSOR 2 READING	Get	i:65	i:65saaaaaaa
	data length 8 characters s sign, 0 for positive readings, - for negative readings aaaaaaa sensor 2 reading, return value depends on configuration, refer to «Setup commands, COMMUNICATION RANGE» for details This function returns direct reading from sensor 2 input.		

Inquiry function	Command		Acknowledgement
	Description		
DEVICE STATUS	Get	i:30	i:30 abcdefgh
	data length 8 characters		
	a	Access Mode	0 = local operation 1 = remote operation 2 = locked remote operation
	b	Control Mode	1 = synchronization 2 = POSITION CONTROL 3 = CLOSED 4 = OPEN 5 = PRESSURE CONTROL 6 = HOLD 7 = LEARN 8 = INTERLOCK OPEN (by digital input) 9 = INTERLOCK CLOSED (by digital input) C = power failure D = safety mode E = error (read «ERROR STATUS» for details)
	c	Power Failure Option	0 = disabled 1 = enabled
	d	Warning	0 = no warnings 1 = warnings (read «WARNINGS» and «ERROR STATUS» for details)
	efg	Reserved	
	h	Simulation	0 = normal operation 1 = system simulation running
	This function returns status information about the valve.		
	Remark: In simulation mode the valve can demonstrate pressure control capability independent of other equipment such as vacuum chamber, flow controller and gauge. Normal operation is not possible when simulation is running.		

Control function	Command		Acknowledgement
	Description		
LEARN STATUS (adaptive pressure controller)	Get	i:32	i:32 abcdefgh
	data length 8 characters a Running 0 = No 1 = Yes b Data set present 0 = Ok 1 = No (Learn necessary) c Abortion 0 = Ok, Learn completed 1 = Abort by user 2 = Abort by control unit d Open pressure 0 = Ok 1 = > 50% learn pressure limit (gas flow too high) 2 = < 0 (no gas flow or zero done with gas flow) e Close pressure 0 = OK 1 = < 10% learn pressure limit (gas flow too low) f Pressure raising 0 = Ok 1 = pressure not raising during LEARN (gasflow missing) g Pressure stability 0 = OK 1 = sensor unstable during LEARN h Reserved do not use This function checks the status of LEARN and indicates if the conditions during LEARN were ok.		
LEARN PRESSURE LIMIT (adaptive pressure controller)	Get	i:34	i:34 aaaaaaaa
	data length 8 characters aaaaaaaaa pressure limit for LEARN, return value depends on configuration, refer to «setup commands, COMMUNICATION RANGE» for details This function returns the pressure limit applied for LEARN.		
ERROR STATUS	Get	i:50	i:50 abc
	data length 3 characters abc error code See in chapter «Trouble shooting» for details. This function returns an error code in case of any malfunction of the device.		

Inquiry function	Command		Acknowledgement
	Description		
WARNINGS	Get	i:51	i:51 abcdefgh
	<p>data length 8 characters</p> <p>a 0 = no service required 1 = service request, it is indicated when the control unit detects that motor steps are apparently not effective. This may happen when the valve is heavily contaminated or the gate seal is heavily sticking. These 'lost' steps are recognized and will be repeated to attempt target position in the short term. But in the medium term the valve requires cleaning or inspection.</p> <p>b 0 = LEARN data set present, 1 = LEARN data set not present</p> <p>c 0 = power failure battery ready 1 = power failure battery not ready</p> <p>d 0 = compressed air supply ok 1 = compressed air supply not ok</p> <p>efgh reserved, do not use</p> <p>This function returns warning information about the valve. If a warning is present countermeasure should be taken. Use RESET command to delete service request bit. Remark: Without LEARN the valve is not able to run pressure control</p>		
THROTTLE CYCLE COUNTER	Get	i:70	i:70 aaaaaaaaaa
	<p>data length 10 characters</p> <p>aaa...aaa number of throttle cycles</p> <p>This function returns the number of throttle cycles. A movement from max. throttle position to open back to max. throttle position counts as one cycle. Partial movements will be added up until equivalent movement is achieved.</p>		
ISOLATION CYCLE COUNTER	Get	i:71	i:71 aaaaaaaaaa
	<p>data length 10 characters</p> <p>aaa...aaa number of isolation cycles</p> <p>This function returns the number of isolation cycles. Each closing of the sealing ring counts as one cycle.</p>		
POWER UP COUNTER	Get	i:72	i:72 aaaaaaaaaa
	<p>data length 10 characters</p> <p>aaa...aaa number of power ups</p> <p>This function returns the number of control unit power ups.</p>		

Inquiry function	Command		Acknowledgement
	Description		
ASSEMBLY	Get	i:76	i:76 xxxxxsyyyyyyabc
	data length	17 characters	
	xxxxxx	position, return value depends on configuration, refer to «Setup commands, COMMUNICATION RANGE» for details	
	s	sign, 0 for positive pressure readings, - for negative pressure readings	
	yyyyyy	pressure, return value depends on configuration, refer to «Setup commands, COMMUNICATION RANGE» for details	
	a	0 = local operation 1 = remote operation 2 = locked remote operation	
	b	0 = Initialization (refer to chapter: «Behavior during power up») 1 = synchronization 2 = POSITION CONTROL 3 = CLOSE 4 = OPEN 5 = PRESSURE CONTROL 6 = HOLD 7 = LEARN 8 = INTERLOCK OPEN (by digital input) 9 = INTERLOCK CLOSE (by digital input) C = power failure D = safety mode E = error (read «ERROR STATUS» for details)	
	c	0 = no warning 1 = warning present (read «WARNINGS» and «ERROR STATUS» for details)	
	This function returns an assembly consisting of POSITION, PRESSURE and main status information for the valve.		
HARDWARE CONFIGURATION	Get	i:80	i:80 abcdefgh
	data length	8 characters	
	a	0 = Power Failure Option (PFO) not equipped 1 = Power Failure Option (PFO) equipped	
	b	0 = ±15V sensor power supply (SPS) not equipped 1 = ±15V sensor power supply (SPS) equipped	
	c	2 = RS232 Interface without analog outputs 3 = RS232 Interface with analog outputs	
	d	1 = 1 sensor version, 2 = 2 sensor version	
	efgh	reserved, do not use	
	This function returns the hardware configuration of the device.		
FIRMWARE CONFIGURATION	Get	i:82	i:82 aaaaaaaa
	data length	8 characters	
	aaaaaaaa	firmware version, e.g. 600P1G0002	
	This function returns firmware version of the device.		
IDENTIFICATION	Get	i:83	i:83 aaaaaaaaaaaaaaaaaaaa
	data length	20 characters	
	aaa...aaa	identification code, e.g. /0001/, unused digits are filled up with spaces (20 hexadecimal)	
	This function returns an identification code. This code is unique for each valve and allows tracing.		

Inquiry function	Command		Acknowledgement
	Description		
FIRMWARE NUMBER	Get	i:84	i:84aaaaaa
	data length 20 characters aaaaaa Firmware number e.g. 700989 This function returns the VAT Firmware number.		

4.11.4 Setup commands

Setup function	Command		Acknowledgement
	Description		
ACCESS MODE	Set	c:01aa	c:01
	data length: 2 characters aa 00 = local operation (service port) 01 = remote operation, change to local enabled 02 = locked remote operation, change to local not possible via service port This function selects the access authorization to the valve. To read access mode use inquiry command DEVICE STATUS. Remark: If ACCESS MODE is local operation and communication to service port is interrupted the valve will automatically change to remote operation.		
VALVE CONFIGURATION	Set	s:04abcdefgh	s:04
	Get	i:04	i:04abcdefgh

	data length 8 characters	
a	Valve position after power up	0 = close 1 = open
b	Valve position after power failure	0 = close 1 = open
c	External isolation valve function	0 = no 1 = yes
d	Control stroke limitation	0 = no 1 = yes
e	Network failure end position	0 = valve will close 1 = valve will open 2 = valve stay on actual position
f	Slave offline position	0 = valve will close 1 = valve will open 2 = valve stay on actual position
g	Synchronization start	0 = standard 1 = special command 2 = open command 3 = all move commands 4 = always
h	Synchronization mode	0 = short 1 = full
	This function does the valve configuration.	
Setup function	Command	
	Acknowledgement	
Description		
SENSOR CONFIGURATION	Set	s:01abcdefgh
	Get	i:01
		s:01
		i:01abcdefgh

<p>data length 8 characters</p> <p>a</p> <p>b</p> <p>cdefgh</p>	<p>0 = no sensor</p> <p>1 = 1 sensor operation (sensor 1 input)</p> <p>2 = 2 sensor operation with automatic changeover (low range = sensor 2 input, high range = sensor 1 input)</p> <p>3 = 1 sensor operation (sensor 2 input)</p> <p>4 = 2 sensor operation with automatic changeover (low range = sensor 1 input, high range = sensor 2 input)</p> <p>Remark: Sensor operation modes 2, 3 and 4 are possible with 2 sensors (653 H - and 653 W -) only.</p> <p>Remark: For applications where the high range sensor is used for for monitoring purpose only, select sensor operation modes 1 or 3 for pressure control with low range sensor and read high range sensor from «SENSOR 2 READING» resp. «SENSOR 1 READING».</p> <p>1 = ZERO enabled, 0 = ZERO disabled</p> <p>High range / Low range sensor full scale ratio * 1'000 (1000 ... 100000). In case of a 1 sensor valve use any value within the valid range.</p> <p>This function does the sensor configuration.</p>
---	--

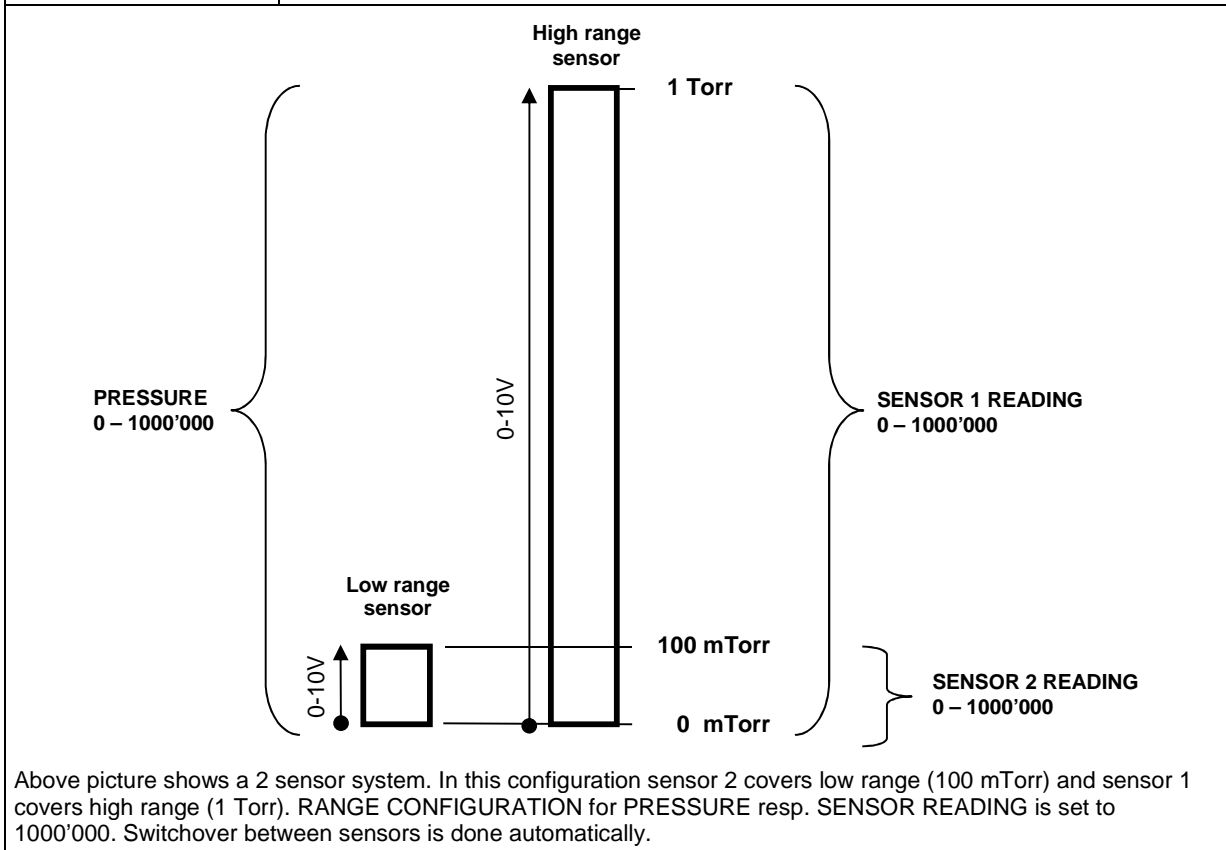

Above picture shows a 2 sensor system. In this configuration sensor 2 covers low range (100 mTorr) and sensor 1 covers high range (1 Torr). RANGE CONFIGURATION for PRESSURE resp. SENSOR READING is set to 1000'000. Switchover between sensors is done automatically.

Setup function	Command	Acknowledgement
	Description	

Setup function	Command		Acknowledgement											
	Description													
	Set	s:05 aaaaabcd	s:05											
	Get	i:05	i:05 aaaaabcd											
SENSOR SCALE	data length 8 characters													
	<table> <tr> <td>a</td> <td>Value</td> <td>00001...99999 (10000 = 1.0000)</td> </tr> <tr> <td>b</td> <td>Sign Exponent</td> <td>0 = "-", 1 = "+"</td> </tr> <tr> <td>c</td> <td>Exponent</td> <td>0...4</td> </tr> <tr> <td>d</td> <td>Pressure Unit</td> <td>0 = Pa 1 = bar 2 = mbar 3 = ubar 4 = Torr 5 = mTorr 6 = atm 7 = psi 8 = psf</td> </tr> </table> <p>Example: 10000114 = 10Torr (input from high range sensor)</p>			a	Value	00001...99999 (10000 = 1.0000)	b	Sign Exponent	0 = "-", 1 = "+"	c	Exponent	0...4	d	Pressure Unit
a	Value	00001...99999 (10000 = 1.0000)												
b	Sign Exponent	0 = "-", 1 = "+"												
c	Exponent	0...4												
d	Pressure Unit	0 = Pa 1 = bar 2 = mbar 3 = ubar 4 = Torr 5 = mTorr 6 = atm 7 = psi 8 = psf												
	Set	s:17 aaaabbbb	s:17											
	Get	i:17	i:17 aaaabbbb											
SENSOR 1 LINEARIZATION	data length 8 characters													
	<table> <tr> <td>a</td> <td>logarithmic resolution[millivolt /decade]</td> <td>0000 = linearizing off 0001 = min. value 9999 = max. value (default value: 0000 = linearizing off)</td> </tr> <tr> <td>b</td> <td>full scale [millivolt]</td> <td>0001 = min. value 9999 = max. value (default value in logarithmic mode: 5324 = 5.324V) (becomes linear full scale = 1000000)</td> </tr> </table> <p>Pressure control algorithm adaptive downstream needs a linear sensor signal, therefore a logarithmic signal must be linearized.</p> <p>Example: s:1700000000 = Linear sensor Example: s:1810007800 = Logarithmic sensor (1.0V/decade, Linear full scale at 7.8V)</p>			a	logarithmic resolution[millivolt /decade]	0000 = linearizing off 0001 = min. value 9999 = max. value (default value: 0000 = linearizing off)	b	full scale [millivolt]	0001 = min. value 9999 = max. value (default value in logarithmic mode: 5324 = 5.324V) (becomes linear full scale = 1000000)					
a	logarithmic resolution[millivolt /decade]	0000 = linearizing off 0001 = min. value 9999 = max. value (default value: 0000 = linearizing off)												
b	full scale [millivolt]	0001 = min. value 9999 = max. value (default value in logarithmic mode: 5324 = 5.324V) (becomes linear full scale = 1000000)												

Setup function	Command		Acknowledgement
	Description		
SENSOR 2 LINEARIZATION	Set	s:18 aaaabbbb	s:18
	Get	i:18	i:18 aaaabbbb
	data length 8 characters a logarithmic resolution[millivolt /decade] 0000 = linearizing off 0001 = min. value 9999 = max. value (default value: 0000 = linearizing off) b full scale [millivolt] 0001 = min. value 9999 = max. value (default value in logarithmic mode: 5324 = 5.324V) (becomes linear full scale = 1000000) Pressure control algorithm adaptive downstream needs a linear sensor signal, therefore a logarithmic signal must be linearized. Example: s:1700000000 = Linear sensor Example: s:1810007800 = Logarithmic sensor (1.0V/decade, Linear full scale at 7.8V)		
SENSOR AVERAGE	Set	s:19 abbbbbbb	s:19
	Get	i:19	i:19 abbbbbbb
	data length 8 characters a Average time 0 = 0.0 sec 1 = 0.1 sec 2 = 0.2 sec 3 = 0.3 sec 4 = 0.4 sec 5 = 0.5 sec 6 = 0.6 sec 7 = 0.7 sec 8 = 0.8 sec 9 = 0.9 sec A = 1.0 sec b Reserved set to 0000000 Remark: For pressure control averaging of sensor signal is not recommended. This function does the sensor average configuration.		

Setup function	Command		Acknowledgement
	Description		
COMMUNICATION RANGE CONFIGURATION	Set	s:21 abcdefgh	s:21
	Get	i:21	i:21 abcdefgh
	<p>data length 8 characters a range for POSITION: 0 = 0 – 1'000, 1 = 0 – 10'000, 2 = 0 – 100'000 bcdefgh upper value for PRESSURE and SENSOR READING: 1000 ... 1000000 e.g. 0010000 -> pressure range 0 – 10'000</p> <p>This function defines the communication range between the valve and the host computer for POSITION, PRESSURE and SENSOR READING. Remark: In case ZERO has been performed, gauge offset for PRESSURE and SENSOR READING is compensated. Remark: In case 2 sensor operation for pressure control is selected, PRESSURE covers high range gauge because switchover between sensors is done automatically. SENSOR 1 READING and SENSOR 2 READING always return full scale values according to selected range.</p>		

Setup function	Command		Acknowledgement)
	Description		
INTERFACE CONFIGURATION	Set	s:20 abcdefgh	s:20
	Get	i:20	i:20 abcdefgh
	data length 8 characters		
	a	baud rate: 0 = 600 1 = 1200k 2 = 2400 3 = 4800 4 = 9600 5 = 19.2k 6 = 38.4k 7 = 57.6k 8 = 115.2k	
	b	parity bit: 0 = even 1 = odd 2 = mark 3 = space 4 = no	
	c	data length: 0 = 7 bit 1 = 8 bit	
	d	number of stop bits: 0 = 1 1 = 2	
	e	0 = IC 8 = PM-V2	
	f	digital input OPEN VALVE: 0 = not inverted 1 = inverted 2 = disabled	
	g	digital input CLOSE VALVE: 0 = not inverted 1 = inverted 2 = disabled	
h	0 (reserved, do not change)		
This function does the 0interface0 and digital input configuration. Remark: Digital outputs are always enabled.			
INTERFACE CONFIGURATION 2	Set	s:22 abbbxxxx	s:22
	Get	i:22	i:22 abbbxxxx
	data length 8 characters		
	a	1 = RS485, 2 = RS485 / Point to Point	
bbb	RS485 address 0...255		
c	0 = full duplex, 1 = half duplex		
xxx	000 (reserved, do not change)		
This function defines the interface configuration for the valve.			

Setup function	Command		Acknowledgement
	Description		
ZERO	Set	Z:	Z:
	<p>This command initiates ZERO to compensate for offset of gauge(s). Remark: Refer to «ZERO» for correct zero procedure.</p>		
PRESSURE ALIGNMENT	Set	c:6002aaaaaaaa	c:60
	<p>data length: 8 characters aaaaaaaaa System base pressure, value depends on configuration, refer to «Setup commands, COMMUNICATION RANGE» for details. Alignment range is equivalent to max. +/-1.4V sensor signal. This command aligns PRESSURE to a certain value. Also SENSOR READING will be aligned accordingly. It might be used instead of ZERO in case base pressure is not low enough.</p>		
LEARN (adaptive)	Set	L:0aaaaaaaa	L:
	<p>data length 8 characters aaaaaaaaa Pressure limit for LEARN, value depends on configuration, refer to «Setup commands, COMMUNICATION RANGE» for details This command starts LEARN. By OPEN VALVE, CLOSE VALVE or POSITION CONTROL commands the routine may be interrupted. Remark: Without LEARN the PID adaptivecontroller is not able to perform pressure control. Refer to «Adaptive algorithm» for correct learn gas flow and procedure.</p>		
DOWNLOAD LEARN DATA	Set	d:pppppppppp	d:ppp
	<p>data length 3 + 8 characters ppp pointer, 000 ... 103 dpppppppp single data set This command downloads the LEARN data sets from the host computer to the valve. There are a total number of 104 data sets. Each data set consists of 8 data bytes and needs to be uploaded separately. Remark: Make sure that all 104 data sets will be downloaded.</p>		
UPLOAD LEARN DATA	Get	u:ppp	u:pppppppppp
	<p>data length 3 + 8 characters ppp pointer, 000 ... 103 dpppppppp single data set This command uploads the LEARN data sets from the valve up to the host. There are a total number of 104 data sets. Each data set consists of 8 data bytes and needs to be uploaded separately. Remark: Make sure that all 104 data sets will be uploaded.</p>		

Setup function	Command		Acknowledgement
	Description		
VALVE SPEED	Set	V:00aaaa	V:
	Get	i:68	i:680000aaaa
	data length 6 characters starting with double zero for writing 8 characters starting with quadruple zero for reading aaaa valve speed, 1 ... 1000 (1 = min. speed, 1000 = max. speed) This command allows changing the actuating speed of the valve plate. Speed selection is effective for pressure control and position control. Open valve and close valve are always done with max. speed. Remark: Refer to «Valve speed adjustment» for details.		
RESET	Set	c:82aa	c:82
	data length 2 characters aa 00 = reset service request bit from WARNINGS 01 = reset FATAL ERROR (restart control unit) This function resets warnings and errors.		
PRESSURE CONTROLLER	Set	s:02Z00a select pressure controller as active pressure controller	s:02
	Get	i:02Z00 get active pressure controller	i:02Z00a
	This command selects the pressure controller mode. a Pressure controller: 0 = Adaptive downstream 1 = Fixed 1 (downstream or upstream) 2 = Fixed 2 (downstream or upstream) 3 = Soft pump Examples: <ul style="list-style-type: none"> To set the soft pump pressure controller as active pressure controller, send s:02Z003 If the answer of the command i:02Z00 is i:02Z002, the fixed 2 pressure controller is active. 		

Setup function	Command		Acknowledgement
	Description		
PRESSURE CONTROLLER CONFIGURATION	Set	s:02abbc configure parameter: set parameter bb of pressure controller a to value c	s:02
	Get	i:02abb get value c of parameter bb of pressure controller a	i:02abbc
	<p>a Pressure controller: A = Adaptive downstream pressure controller B = Fixed 1 pressure controller (downstream or upstream) C = Fixed 2 pressure controller (downstream or upstream) D = Soft pump pressure controller</p> <p>bb Parameter number (see table below)</p> <p>c Parameter value, depends on parameter number a floating-point type or a integral type value, max length = 20 characters</p> <p>floating-point type format: x.y or x Maximum length of expression: 12 Examples: 3455.1505, 21154.0 or 318</p> <p>integer type format: x Maximum length of expression: 12 Examples: 9785, 4565, 1</p> <p>For details (commands etc.), see the next tables.</p>		

4.11.4.1 Overview pressure controller

Parameter	Parameter number (bb)	Pressure controller (a)			
		A Adaptive	B Fixed 1	C Fixed 2	D Soft pump
SENSOR DELAY	00	✓	–	–	–
RAMP TIME	01	✓	✓	✓	✓
RAMP MODE	02	✓	✓	✓	✓
CONTROL DIRECTION	03	–	✓	✓	–
P-GAIN (for A = GAIN FACTOR)	04	✓	✓	✓	✓
I-GAIN	05	–	✓	✓	–

✓ Existent for this pressure controller / – Not used for this pressure controller

Command examples:

Set GAIN FACTOR of the adaptive pressure controller to the value 1.075	s:02A041.075
GET GAIN FACTOR of adaptive pressure controller	i:02A04 → Answer is i:02A041.075 → Value = 1.075
Set RAMP TIME of soft pump pressure controller to the value 281 seconds	s:02D01281
Get RAMP TIME of soft pump pressure controller	i:02D01 → Answer is i:02D01281 → Value = 281

4.11.5 Pressure control algorithm
4.11.5.1 Adaptive control algorithm (downstream)

Parameter	Command		Request	Data Type	Values
SENSOR DELAY	Set	s:02A00c	s:02	FLOAT	c = 0.00...1.00 Default is: 0.00 s
	Get	i:02A00	i:02A00c		
RAMP TIME	Set	s:02A01c	s:02	FLOAT	c = 0.00...1'000'000.0 Default is: 0.00 s
	Get	i:02A01	i:02A01c		
RAMP MODE	Set	s:02A02c	s:02	UINT	c = 0 or 1 0 = constant time 1 = constant slope Default is: 0
	Get	i:02A02	i:02A02c		
GAIN FACTOR	Set	s:02A04c	s:02	FLOAT	c = 0.0001...7.5 Default is: 1.0
	Get	i:02A04	i:02A04c		

Explanation:
SENSOR DELAY

Sensor response time [s]

The SENSOR DELAY is a control parameter to compensate delays during the pressure detection. Pipes and orifices for sensor attachment can cause delays in response time and could impact badly the pressure control stability. By adapting this parameter to the approximate delay time stability problems can be reduced. But control response time will be slowed down by this measure.

RAMP TIME

Pressure setpoint ramp time [s]

RAMP MODE

Mode = 0 Constant Time	The RAMP TIME is dependent on the adjusted parameter ramp time and is always the same independent of the control deviation. That means the ramp time from the actual value to the setpoint value is the adjusted parameter ramp time value.
Mode = 1 Constant Slope	The RAMP TIME is dependent on the adjusted parameter ramp time and is different depending on the control deviation. The RAMP TIME is calculated corresponding to the sensor full scale value (10V). Ramp time = 10 sec.; ramp time slope is SFS (10V) in 10 Seconds.

In the adaptive pressure controller mode, the RAMP TIME parameter also can be a value to minimize over- / undershooting. The ramp could be used to harmonize the adaptive control algorithm.

GAIN FACTOR

The GAIN FACOTR is a control parameter to adapt the performance of the pressure control algorithm. A higher gain results in faster response, higher over- / undershoot of pressure. A lower gain results in slower response, lower over- / undershoot of pressure.

Example:

Set SENSOR DELAY of the adaptive pressure controller to the value 0.75

Command	Pressure controller	Parameter selection variable	Parameter value (seconds)
s:02	A (a)	00 (bb)	0.75 (c)

→ s:02A000.75



To optimize adaptive control algorithm, refer to chapter «Tuning of control performance».

4.11.5.2 Fixed 1 control algorithm

Parameter	Command		Request	Data Type	Values
RAMP TIME	Set	s:02B01 c	s:02	FLOAT	c = 0.00...1'000'000.0 Default is: 0.00
	Get	i:02B01	i:02B01 c		
RAMP MODE	Set	s:02B02 c	s:02	UINT	c = 0 or 1 0 = constant time 1 = constant slope Default is: 0
	Get	i:02B02	i:02B02 c		
CONTROL DIRECTION	Set	s:02B03 c	s:02	UINT	c = 0 or 1 0 = downstream 1 = upstream Default is: 0
	Get	i:02B03	i:02B03 c		
P-GAIN	Set	s:02B04 c	s:02	FLOAT	c = 0.001...100 Default is: 0.1
	Get	i:02B04	i:02B04 c		
I-GAIN	Set	s:02B05 c	s:02	FLOAT	c = 0...100.0 Default is: 0.1
	Get	i:02B05	i:02B05 c		

Explanation:

RAMP TIME

Pressure setpoint ramp time [s]

RAMP MODE

Mode = 0 Constant Time	The RAMP TIME is dependent on the adjusted parameter ramp time and is always the same independent of the control deviation. That means the ramp time from the actual value to the setpoint value is the adjusted parameter ramp time value.
Mode = 1 Constant Slope	The RAMP TIME is dependent on the adjusted parameter ramp time and is different depending on the control deviation. The RAMP TIME is calculated corresponding to the sensor full scale value (10V). Ramp time = 10 sec.; ramp time slope is SFS (10V) in 10 Seconds.

CONTROL DIRECTION

The CONTROL DIRECTION defines the type of application, if the valve is mounted in downstream or upstream. Downstream means the valve is after the chamber and before the pump. Upstream, valve is mounted before chamber and pump.

P-GAIN / I-GAIN

The P-GAIN is the proportional factor of the fixed control algorithm. The I-GAIN is the integral factor.

Example:

Set RAMP MODE of the Fixed 1 pressure controller to the value 0 (fixed time)

Command	Pressure controller	Parameter selection variable	Parameter value
s:02	B (a)	02 (bb)	0 (c)

→ s:02B020



To optimize Fixed 1 control algorithm, refer to chapter «Tuning of control performance».

4.11.5.3 Fixed 2 control algorithm

Parameter	Command	Request	Data Type	Values
RAMP TIME Pressure setpoint ramp time [s]	Set	s:02C01c	s:02	FLOAT c = 0.00...1'000'000.0 Default is: 0.00
	Get	i:02C01	i:02C01c	
RAMP MODE	Set	s:02C02c	s:02	UINT c = 0 or 1 0 = constant time 1 = constant slope Default is: 0
	Get	i:02C02	i:02C02c	
CONTROL DIRECTION	Set	s:02C03c	s:02	UINT c = 0 or 1 0 = downstream 1 = upstream Default is: 0
	Get	i:02C03	i:02C03c	
P-GAIN	Set	s:02C04c	s:02	FLOAT c = 0.001...100 Default is: 0.1
	Get	i:02C04	i:02C04c	
I-GAIN	Set	s:02C05c	s:02	FLOAT c = 0...100.0 Default is: 0.1
	Get	i:02C05	i:02C05c	

Explanation: Refer to: «Fixed 1 control algorithm»

4.11.5.4 Soft pump control algorithm

Parameter	Command	Request	Data Type	Values	
RAMP TIME	Set	s:02D01 c	s:02	FLOAT	c = 0.00...1'000'000.0 Default is: 0.00
	Get	i:02D01	i:02D01 c		
RAMP MODE	Set	s:02D02 c	s:02	UINT	c = 0...1 0 = constant time 1 = constant slope Default is: 0
	Get	i:02D02	i:02D02 c		
P-GAIN	Set	s:02D04 c	s:02	FLOAT	c = 0.001...100 Default is: 0.1
	Get	i:02D04	i:02D04 c		

Explanation:

RAMP TIME

Pressure setpoint ramp time [s]

RAMP MODE

Mode = 0 Constant Time	The RAMP TIME is dependent on the adjusted parameter ramp time and is always the same independent of the control deviation. That means the ramp time from the actual value to the setpoint value is the adjusted parameter ramp time value.
Mode = 1 Constant Slope	The RAMP TIME is dependent on the adjusted parameter ramp time and is different depending on the control deviation. The RAMP TIME is calculated corresponding to the sensor full scale value (10V). Ramp time = 10 sec ; ramp time slope is SFS (10V) in 10 Seconds.

P-GAIN

The P-GAIN is the proportional factor of the fixed control algorithm.



To optimize soft pump control algorithm, refer to chapter «Tuning of control performance».

4.11.6 Error messages

Description	Error message
Protocol	
Parity error	E:000001
Input buffer overflow (to many characters)	E:000002
Framing error (data length, number of stop bits)	E:000003
Overrun (Service interface: Input buffer register overflow)	E:000004
Commands	
<CR> or <LF> missing	E:000010
: missing	E:000011
Invalid number of characters (between : and)	E:000012
Invalid value	E:000023
Value out of range	E:000030
Hardware	
Pressure mode, Zero or Learn without Sensor	E:000040
Command not applicable for hardware configuration	E:000041
Setup	
ZERO disabled	E:000060
Device Status	
Command not accepted due to local operation	E:000080
Command not accepted, Service Interface locked	E:000081
Command not accepted due to synchronization, CLOSED or OPEN by digital input, safety mode or fatal error	E:000082
Not accepted calibration and test mode	E:000089

4.12 RS232 interface - commands (PM-V2 protocol)

4.12.1 Control commands (PM-V2 compatible)

Note:

Control commands are accepted only, when the PM controller is in REMOTE mode, except of all U: commands

Control commands are acknowledged by one or two acknowledgements:

1st answer: Confirmation that command has been received, within 40 ms

2nd answer: If enabled, confirmation that command has been executed (except S: command: no 2nd answer will be replied)

<CR>...Carriage Return (0D hexadecimal); <LF>...Linefeed (0A hexadecimal)

Description	Commands	Acknowledgements (2nd acknowledgement)	Examples / Explanation
Remote Operation	U:01	U:	= switch to Remote
Local Operation	U:02	U:	= switch to Local
Close valve	C:	C: (C:<CR><LF>)	= close
Open valve	O:	O: (O:<CR><LF>)	= open
Select valve position in 1/1000 of stroke (0000 = closed, 1000 = pen)	R:xxxxxx	R: (R:)	R:000428 = 428 / 1000 of stroke
Zero Sensor offset adjustment	Z:	Z:	automatic zero adjustment of both sensors and all voltage ranges
Autolearn Xxxxxx = maximum pressure to be learned, 0 - communication range (C.R.)	L:xxxxxx	L:	L:100000 = up to sensor full scale (communication range set to 100000)
Pressure setpoint Xxxxxx = setpoint value 0 - communication range (C.R.)	S:xxxxxx	S: (no 2 nd answer)	S:000119 119 = C.R./F.S. * setpoint
Hold mode Freeze valve position	H: K:	H: K:	= start hold = change to pressure mode Note: Command can be used in pressure and position mode.
Reduced positioning speed in 1/1000 of maximum speed (remains stored until next speed is given and is set to 1000 after mains is switched off) Function is active for R: commands only	V:xxxxxx	V:	V:000200 R:000428 = Actuator speed is 200* 1/1000 = 20% of maximum speed, while gate is moved to position 428* 1/1000 = 428
Disable power fail option Enable power fail option (if installed)	U:14 U:15	U: U:	After power-up PFO is always enabled (if installed)
Interlock service software window with integrated controller	U:03 U:04	U: U:	= interlock Local/Remote buttons = release Local/Remote buttons
Disable logic inputs Enable logic inputs	U:16 U:17	U: U:	= Disable logic inputs = Enable logic inputs
Only sensor 1 used	U:18	U:	= only sensor 1 used
Only sensor 2 used	U:19	U:	= only sensor 2 used
Sensor 1 and 2 used (auto switching)	U:20	U:	= sensor 1and 2 used
Plasma mode duration time Xxxxxx = 000000 – 30000 ms	k:01xxxxxx	K01:	10 ms steps possible
Plasma mode filter time Xxxxxx = 000010 – 30000 ms	k:02xxxxxx	K02:	1 ms steps possible

4.12.2 Inquiry commands (PM-V2 compatible)

<CR>...Carriage Return (0D hexadecimal); <LF>...Linefeed (0A hexadecimal)

Description	Commands	Acknowledgements	Examples / Explanation
Actual valve position in 1/1000 of stroke (0 = closed, 1000 = open)	A:	A:xxxxxx	A:000428 = 428 * 1/1000 of stroke
Actual pressure in units of 1/communication range of sensor 1 full scale	P:	P:xxxxxx	P:000119 = 119 / communication range * sensor 1 full scale pressure P:-00004 = -4 / communication range * sensor 1 full scale pressure
Actual pressure (xxxxxx) Pressure of sensor 1 (yyyyyy) Pressure of sensor 2 (zzzzzz)	X:	X:xxxxxxxxyyyyyzzzzz	sensor 1 = 250mTorr, sensor 2 = 10Torr communication range = 100000 pressure = 119.0mTorr X:001190001190001190 pressure = 1320mTorr X:013200002500013200 ranges: xxxxxx = - 00350 to 100000 yyyyyy = - 00350 to 002500 zzzzzz = -14000 to 100000
Pressure setpoint in units of 1/communication range of sensor 1 full scale	W:	W:xxxxxx	W:000119 = 119 / communication range * sensor full scale pressure
Read remote / local status	I:	I:REMOTE I:LOCAL	= remote mode = local mode
Read control mode	M:	M: POS M: PRESS	= position mode = pressure mode
Self test	T:	T: OK T:PAR-ER T:ROM-ER	= memory o.k. = parameter error = EPROM error (see section «Trouble shooting» if «PAR-ER» or «ROM-ER» appears)
Read valve cycle counter	c:	c:xxxxxxxxxx	c:0000125013 = 125'013 cycles
Reset valve cycle counter	n:	n:	= set counter to zero

Description	Commands	Acknowledgements	Examples / Explanation
Software version	i:01	i:01xxxxxxx	i:0165PM3G00 = software version 65PM.3G.00
Read current sensor setup	i:02	i:02abcdefg	Current sensor setup; for abcdefg refer to setup command s:
Read offset of sensor 1	i:08	i:08xxxxxx	i:08-00013 offset = 13 /1000 * sensor 1 full scale pressure
Read offset of sensor 2	i:07	i:07xxxxxx	i:07-00009 offset = -9 /1000 * sensor 2 full scale pressure
Position / air error	p:	p:___OK p:POS-ER p:AIR-ER	= position o.k. = plate position error = compressed air failure
Valve status	i:04	i:04V1:aV2:b	a = 1 (valve 1 active) a = 0 (valve 1 inactive) b = - (not connected)
Valve position	i:05	i:05V1:aV2:b	a = 0 (valve 1 open) a = C (valve 1 closed) a = N (valve 1 in intermediate pos.) b = - (not connected)
Plasma mode duration	l:01	l:01xxxxxx	xxxxxx = ms
Plasma mode filter time	l:02	l:02xxxxxx	xxxxxx = ms

4.12.3 Setup command (PM-V2 compatible)

The setup command can be used same with PM-6 and integrated controller, but the single values in the command can be different as mentioned in the following table.

Description	Command / Acknowledgement		Difference
Sensor Setup	s: abcdefg / s:		
a = Sensor Type	0 = Torr 1 = mbar		Ignored with integrated controller (can be set via service software)
b = Sensor 1 Full Scale Range (Torr or mbar)	0 = 0 - 0.010 1 = 0 - 0.020 2 = 0 - 0.025 3 = 0 - 0.050 4 = 0 - 0.100 5 = 0 - 0.200 6 = 0 - 0.250 7 = 0 - 0.500 8 = 0 - 1.0 9 = 0 - 2.0 A = 0 - 2.5 B = 0 - 5.0	C = 0 - 10 D = 0 - 20 E = 0 - 25 F = 0 - 50 G = 0 - 100 H = 0 - 200 I = 0 - 250 J = 0 - 500 K = 0 - 1000 L = not connected	Sensor 1 has to be the sensor with lower range Therefore sensor 1 cannot be used alone with integrated controller
c = Sensor 2 Full Scale Range (Torr or mbar)	0 = 0 - 0.010 1 = 0 - 0.020 2 = 0 - 0.025 3 = 0 - 0.050 4 = 0 - 0.100 5 = 0 - 0.200 6 = 0 - 0.250 7 = 0 - 0.500 8 = 0 - 1.0 9 = 0 - 2.0 A = 0 - 2.5 B = 0 - 5.0	C = 0 - 10 D = 0 - 20 E = 0 - 25 F = 0 - 50 G = 0 - 100 H = 0 - 200 I = 0 - 250 J = 0 - 500 K = 0 - 1000 L = not connected (only with PM-6)	Sensor 2 has to be the sensor with higher range L is not available with integrated controller because sensor 2 always has to be connected (sensor 1 cannot be used alone)
d = Display Unit	0 = mbar 1 = μ bar 2 = Torr 3 = mTorr 4 = Pa 5 = kPa 6 = position mode only		Ignored with integrated controller (can be set via service software)
e = RS232 Communication Range, CR (range represents the range of higher range sensor)	0 = 0 - 1000 1 = 0 - 2000 2 = 0 - 2500 3 = 0 - 5000	4 = 0 - 10000 5 = 0 - 20000 6 = 0 - 25000 7 = 0 - 50000 8 = 0 - 100000	
f = Gain Factor	0 = 1.00 1 = 1.33 2 = 1.78 3 = 2.37 4 = 3.16 5 = 4.22 6 = 5.62 7 = 7.50	8 = 0.10 9 = 0.13 A = 0.18 B = 0.23 C = 0.32 D = 0.42 E = 0.56 F = 0.75	
g = Zero Adjust	0 = enable 1 = disable		



4.12.4 Sensor delay command (PM-V2 compatible)



Description	Commands		Acknowledgements	Examples / Explanation
	t:abcdefg		t:	t:4000000
a = Response Time	0 = 0 ms 1 = 20 ms 2 = 40 ms 3 = 60 ms 4 = 80 ms 5 = 100 ms 6 = 150 ms 7 = 200 ms	8 = 250 ms 9 = 300 ms A = 350 ms B = 400 ms C = 500 ms D = 600 ms E = 800 ms F = 1000 ms		4 = Sensor response time 80 ms
bcdefg = Reserved	000000			Use 000000 only

4.12.5 Error messages (PM-V2 compatible)

Error messages	Description
E:000001	Parity error
E:000002	<CR> or <LF> is missing
E:000003	«:» is missing
E:000004	Wrong letter code
E:000005	Numerical value not given in 6 digits
E:000006	Numerical value larger 1000
E:000007	PRESSURE MODE, ZERO or LEARN have been selected with no sensor connected (display format set for no sensor)
E:000008	Controller is not in correct mode for the given command (e.g. L:XXXXXX given while a logic input is activated)
E:000009	Valve is not able to execute the command (e.g. the valve is in error state)
E:000200	<u>Error with ZERO</u> - valve is not in open position - PM controller is switched in control mode PRESSURE MODE - function ZERO blocked (= DISABLED)
E:000201	Sensor with the higher full scale: if zero offset is higher than +/- 1.4 V
E:000202	Sensor with the lower full scale: if zero offset is higher than +/- 1.4 V (this error message is not active when only one sensor is connected)
E:000203	<u>Sensor setup error</u> The full scale ratio Sensor 1 / Sensor 2 is either >100 or <= 1
E:000204	Commands U:19 or U:20 sent with one or no sensor connected

5 Operation

	 WARNING
	<p>Unqualified personnel Inappropriate handling may cause serious injury or property damage. Only qualified personnel are allowed to carry out the described work.</p>

	 WARNING
	<p>Valve opening Risk of serious injury. Human body parts must be kept out of the valve opening and away from moving parts. Do not connect the controller to power before the valve is installed complete into the system.</p>

5.1 Normal operation

This valve is designed for downstream pressure control in vacuum chambers. It can be employed in a pressure control mode or a position control mode. In both cases local or remote operation is possible.

5.1.1 Remote operation

This product is equipped with a RS232 interface to allow for remote operation. See section «RS232 interface» for details. 'Control Performance Analyzer' software may be used for monitoring during remote control.

'Control Performance Analyzer' 4.0 software

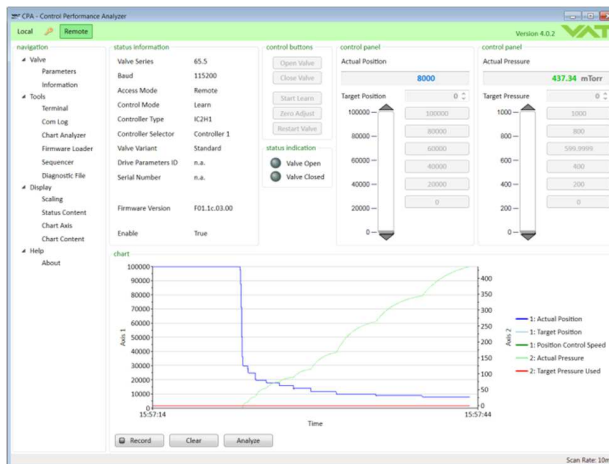

sample picture



In case 'Control Performance Analyzer' is used, make sure 'Remote' button is pushed to enable for remote operation.

5.1.2 Local operation

Local operation means that the valve is operated via the service port using a computer. You can use our software 'Control Performance Analyzer' for Local operation, which is integrated in the controller. The software is beneficial especially for setup, testing and maintenance.

How to start:

1. Connect service cable (USB A–B cable male-male) between PC and valve:

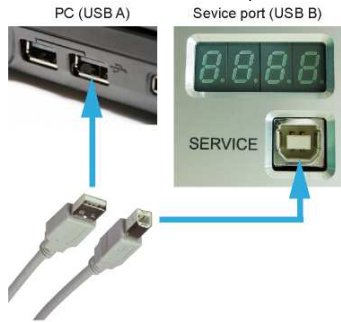

A drive opens:

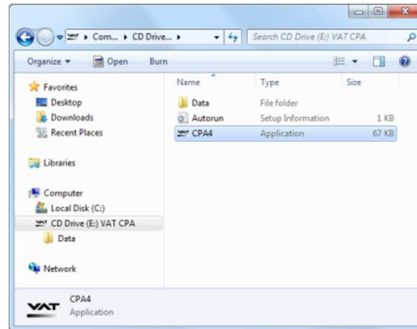

2. Double Click on 'CPA4.exe' to open the 'Control Performance Analyzer'

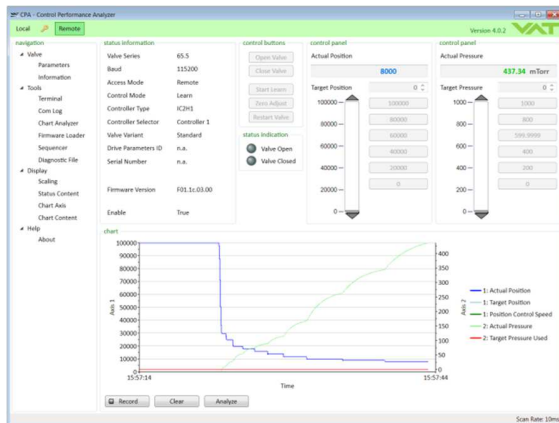

3. Click [Local] for Local operation to do configurations



When communication to service port is interrupted the valve will change to remote operation. So when service cable will be disconnected or software will be shut down, the valve returns automatically to remote operation. This may result in an immediate movement of the valve depending on remote control.

5.2 Close valve

Local operation: (‘Control Performance Analyzer’)	Remote operation: (Refer to chapter «OUTPUT Buffer» > «CONTROL MODE SETPOINT» for details)
Push CLOSE button	<ol style="list-style-type: none"> 1. «OUTPUT Buffer» > «CONTROL MODE SETPOINT» 2. Select [Close] (value = 3)

5.3 Open valve

Local operation: (‘Control Performance Analyzer’)	Remote operation: (Refer to chapter «OUTPUT Buffer» > «CONTROL MODE SETPOINT» for details)
Push OPEN button	<ol style="list-style-type: none"> 1. «OUTUT Buffer» > «CONTROL MODE SETPOINT» 2. Select [Open] (value = 4)

5.4 Position control

The valve position is directly controlled according to the position setpoint.

Local operation: (‘Control Performance Analyzer’)	Remote operation: (Refer to chapter «OUTPUT Buffer» > «POSITION SETPOINT» for details)
Select or enter position setpoint	<ol style="list-style-type: none"> 1. In «OUTPUT Buffer» > « POSITION SETPOINT» 2. Select a valid value 3. In «OUTPUT Buffer» > «CONTROL MODE SETPOINT» 4. Select [Position] (value = 2)

5.5 Pressure control



To prepare valve for PRESSURE CONTROL perform complete «Setup procedure». The valve has parameters that may be modified to tune pressure control performance. Refer to «Tuning of control performance».

The included PID controller controls the chamber pressure according to the pressure setpoint by means of the valve position. The PID controller works with an adaptive algorithm to achieve best results under altering conditions (gasflow, gas type).

Local operation: with ‘Control Performance Analyzer’ 4.0, refer to chapter: «Local operation»	Remote operation:
<ol style="list-style-type: none"> 1. Open the CPA 4.0 2. Click [Local] 3. Click [Parameters] 4. Click [Pressure Control] and do the settings 5. Click [Save] 	Refer to “RS485 control commands” for details.

5.6 Display information

There is a 4 digit display located on the controller.
It displays configuration, status and position information.
For details refer to following tables.

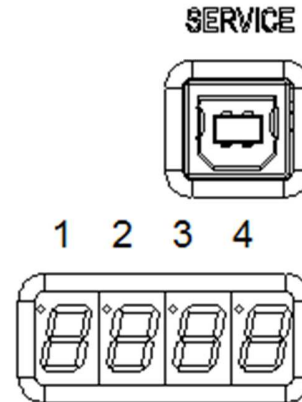

5.6.1 Power up

Description	Digit 1	Digit 2	Digit 3	Digit 4
• 1 st Power On: All dots are illuminated	#	#	#	#
• 2 nd information for about 3s Valve type [e.g.]		6	7	0
• 3 rd information for about 3s: Firmware generation and Firmware Type [e.g. 01.0C]	0	1	0	C
• 4 th information for about 3s: Firmware version and firmware revision [e.g. 07.00]	0	7	0	0
• 5 th information for about 3s: Controller configuration. [e.g. 11.00] Refer to «Safety mode» for details.	Controller Type (1=EC2)	Interface Type (1=RS232/RS485, 2=EtherCAT, 3=DeviceNet) 5=Logic	Option Type	
			0	0 (none)
			0	1 (SPS)
			0	2 (PFO)
			0	3 (Cluster)
			0	4 (SPS & PFO)
			0	5 (SPS & Cluster)
			0	6 (PFO & Cluster)
0	7 (SPS & PFO & Cluster)			

'Ho' indicates power up homing is running	H	o		
---	---	---	--	--

5.6.2 Operation

Description / Mode	Digit 1	Digit 2	Digit 3	Digit 4
Start up (init)	I	n	-	-
Start up (init) leak tight	I	n	-	C
Valve closed (leak tight)	C	-	-	C
Valve open	O	0...100 = valve position (0 = minimal conductance 100 = max. open)		
PRESSURE CONTROL mode	P			
POSITION CONTROL mode (e.g. A..0 = min. conductance)	A			
Closed / open interlock (Valve closed / open by digital input)	I			
HOLD (position frozen) activated	H			
LEARN running	L			
Safety mode established. Refer to «Safety mode» for details.	S			
Power failure	F			

5.6.3 Error

Description	Digit 1	Digit 2	Digit 3	Digit 4
Error number (xyz)	E	x	y	z
alternately (if error code exist)				
Error code	-	u	v	w



For Error number / code. Refer to «Trouble shooting» for details

5.6.4 Safety mode

By means of an external switch (see connection diagrams «Electrical connection») the motor power supply can be interrupted. In this case the valve enters the 'safety mode'. This motor interlock prevents the valve from moving (e.g. maintenance work). Data reading from the control unit remains possible. When motor interlock is active during power up the valve directly enters the 'safety mode' and is not able to do homing. Display shows 'S.XXX' (XXX = value position of valve or C..C for close). In this case homing cycle will be done when motor interlock is deactivated. Then Display shows 'Ho' (Homing) for a moment followed by 'A. 0'

When 'safety mode' is entered from operation (i.e. pressure control mode), the unit will automatically switch to position control mode and remain at current position. Once motor interlock is deactivated the unit remains in position control mode.

5.7 Operation during power up

Valve position before power up:	Reaction of valve:	
	Valve power up configuration = closed (default)	Valve power up configuration = open
Closed (isolated)	Valve remains closed. Display shows 'C C'. Homing will be done when first movement command is received.	Valve runs to maximum throttle position to detect the limit stops to do homing. Display shows configuration of product resp. 'Ho' until homing is done. Valve position after power up is 'A. 0' min. conductance.
All other than closed (not isolated)	Valve runs to max. throttle position to detect limit stop for homing. Display shows configuration of product resp. 'Ho' until homing is done, and afterwards to close position. Display shows 'C C'.	
	Valve position after power up is closed	Valve position after power up is open

Refer also to chapter: «Display information».

5.8 Behavior in case of power failure

Valve position before power failure:	Reaction of valve:	
	Without Power Failure Option (PFO)	With Power Failure Option (PFO)
	653 G	653 H
	653 A	653 C
	653 T	653 U
	653 V	653 W
Closed (isolated)	Valve remains closed.	Valve will close or open depending on valve configuration 1).
Valve open or in any intermediate position	Sealing ring moves down and blocks the pendulum plate at the current position.	Default is not defined. Display indicates F .

1) Provide that battery pack of the VAT controller is charged. Charging time after power up is 2 minutes max..



All parameters are stored in a power fail save memory.

5.9 Operation under increased temperature

	⚠ CAUTION
	<p>Hot valve</p> <p>Heated valve may result in minor or moderate injury.</p> <p>Do not touch valve and heating device during operation. Once heating is switched off (valve and system) await until the valve is cooled down complete before doing any work.</p>



This valve may be operated in the temperature range mentioned in chapter «Technical data».

5.10 Behavior In case of compressed air pressure drop

Valve position before pressure drop:	Reaction of valve:
Valve closed	Valve remains closed.
Valve open or in any intermediate position	Sealing ring moves down and blocks the pendulum plate at the current position.



Refer to chapter: «Troubleshooting» for details.

6 Trouble shooting

6.1.1 Controller Display

Description	Digit 1	Digit 2	Digit 3	Digit 4
Error number (xyz)	E	x	y	z
alternately (if error code exist)				
Error code	-	u	v	w

6.1.2 Error numbers



Error numbers are three-digit decimal numbers (**xyz**) whereas:

x = component	y = mode	z = error type
1 = All Motor Units 2 = Motor Unit 1 3 = Motor Unit 2 8 = Other	0 = Homing 2 = Operation Mode 8 = Other	0 = Position Error ¹⁾ 1 = Not running: No communication with component x 2 = Error State: component x is running but in Status Error 8 = Other

¹⁾ Only in combination with component 1, 2, 3

6.1.3 Error code

Error Code	Description			Solution	
	u	v	w		
			1	No valve connected	Connect valve controller to the valve
			2	Non volatile memory failure	Replace valve controller
			3	Analog digital converter of sensor input failure	Replace valve controller
			4	Initialization of motion controller failed	<ul style="list-style-type: none"> Wrong motion controller firmware version → Update motion controller firmware
			5	Encoder index pulse not found	<ul style="list-style-type: none"> Encoder failure O-Ring sticking 1)
			6	Initialization of interface module failed	<ul style="list-style-type: none"> Fieldbus: Valve firmware does not support interface type → Update valve firmware Wrong interface firmware version → Update interface firmware
	1		0	Closing position can't be reached	<ul style="list-style-type: none"> 1)
	1		1	Homing position can't be reached	<ul style="list-style-type: none"> 1)
	1		2	Motion controller: Internal voltage error	<ul style="list-style-type: none"> Check power supply
	1		3	Motion controller: Internal error temperature	<ul style="list-style-type: none"> Check for a heat accumulation
	1		4	Motion controller: Unexpected behavior	Contact vat support

			<ul style="list-style-type: none"> • Achsen vertauscht • Encoder nicht angeschlossen
1	5	Motion controller: Target position can't be reached	<ul style="list-style-type: none"> • 1) • Current settings
1	6	Motion controller: Position minimal conductance cannot be reached	<ul style="list-style-type: none"> • 1) • Check Plate and Seal ring • Check Parameter "Isolation Position Enter [r]"
1	7	Motion controller: Position to push back the Differential Plate cannot be reached	<ul style="list-style-type: none"> • 1) • Check Different Plate • Check Parameter "Differential Plate Push Back Position [r]"
1	8	Motion controller: Minimal isolation position cannot be reached	<ul style="list-style-type: none"> • 1) • Check Plate and Seal ring • Check Parameter "Isolation Position [r]"
2	0	Break slippery detected	Replace actuator
3	0	SFV: Motion controller failure in master-slave communication	Contact vat support
4	0	Compressed air error	Check compressed air
4	2	Power supply, low voltage detected	Check if power supply is ok and is able to deliver needed power
9	6	SFV: Position deviation axis1 to axis2 at homing procedure	<ul style="list-style-type: none"> • O-Ring sticking • 1)
9	7	SFV: Position deviation axis1 to axis2 at operating	1)
9	8	Position error during closing procedure	1)
9	9	Position error at operating	1)
2	0	0	Valve configuration error, not possible to operate the valve with these configuration
7	7	7	Do not operating mode active

1) Mechanical movement problem:

- Check for differential pressure
- Remove foreign object in movement area
- Eliminate tight movement
- Repair mechanical failure



If you need any further information, please contact one of our service centers. You will find the addresses on our website: www.vatvalve.com.

7 Maintenance

	<p style="text-align: center;">WARNING</p> <p>Unqualified personnel Inappropriate handling may cause serious injury or property damage. Only qualified personnel are allowed to carry out the described work.</p>
	<p style="text-align: center;">WARNING</p> <p>Valve opening Risk of serious injury. Human body parts must be kept out of the valve opening and away from moving parts. Disconnect power on controller before doing any work.</p>
	<p style="text-align: center;">CAUTION</p> <p>Hot valve Heated valve may result in minor or moderate injury. Do not touch valve and heating device during operation. Once heating is switched off (valve and system) await until the valve is cooled down complete before doing any work.</p>
	<p style="text-align: center;">NOTICE</p> <p>Contamination Gate and other parts of the valve must be protected from contamination. Always wear clean room gloves when handling the valve.</p>

7.1 Maintenance intervals

Under clean operating conditions, the valve does not require any maintenance during the specified cycle life. Contamination from the process may influence the function and requires more frequent maintenance.

Before carrying out any maintenance, please contact VAT. It has to be individually decided whether the maintenance can be performed by the customer or has to be carried out by VAT. Please write down the fabrication number of the valve before contact VAT. Refer to chapter «Identification of product» for fabrication number.

7.2 Maintenance procedures

Two maintenance procedures are defined for this valve. These are:

- **Replacement of isolation seals** (gate and body seal of sealing ring) **and valve cleaning**
- **Replacement of actuator shaft seals**



Required frequency of cleaning and replacement of seals is depending on process conditions.

VAT can give the following recommendations for preventive maintenance:

Replacement of	unheated ¹⁾	heated $\leq 80\text{ °C}$ ¹⁾	heated $> 80\text{ °C}$ ¹⁾
isolation seals (gate and body seal of sealing ring)	12 month but max. 200'000 cycles	6 months but max. 200'000 cycles	3 months but max. 200'000 cycles
actuator shaft seals	1'000'000 cycles	6 months	3 months



¹⁾ Those figures are reference values for clean conditions under various temperatures. These values do not include any impact of the process. Therefore preventive maintenance schedule has finally to be checked for the actual process conditions.

NOTICE	
	<p>Vacuum grease</p> <p>Vacuum grease may be distributed and contaminate the valve.</p> <p>Prevent gap between body and sealing ring from air gun cleaning. Do not clean the gap between body and sealing ring with compressed air.</p>



See figure below:



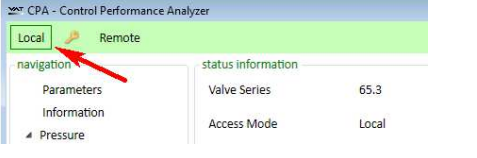
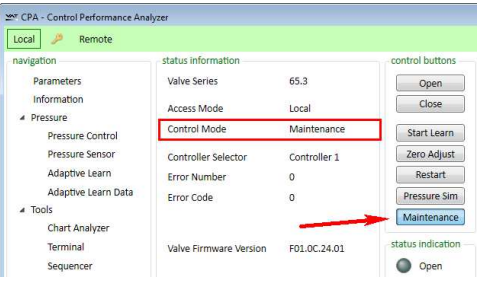
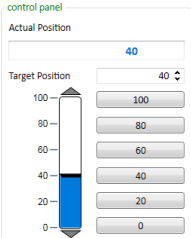

7.2.1 Replacement of isolation seals and valve cleaning

7.2.1.1 Required tools

- Allen Wrench 5mm
- Open end wrench 13mm
- Service cable USB Type A to B (PC to valve Service connector)
- Clean room wiper
- Vacuum grease (see chapter spare parts)
- O-ring removal tool (see chapter Accessories)
- Isopropyl alcohol

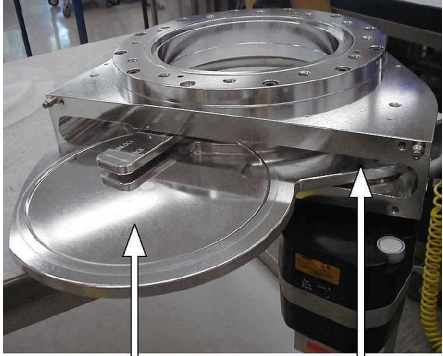
Description	Required tool
 <p>Electrical power and compressed air is required to perform steps 1 to 11 during disassembly respectively 11 to 1 during assembly.</p>	
<p>1. Set the valve to local mode</p> <p>2. Activate "Maintenance" (reduced speed)</p> <p>Now use the position buttons to move the valve plate. The valve will now move in a very low speed</p> <p>Alternatively, the remote interface can be used:</p> <p style="padding-left: 40px;">Set "Control Mode" to 'Maintenance'</p> <p style="padding-left: 40px;">Now use "Target Position" to move the valve</p>	<div style="display: flex; flex-direction: column;">    </div> <p style="text-align: right;">Service cable (PC to valve Service connector)</p>
<p>3. Vent both valve chambers.</p> <p>4. Open the 4 bonnet screws and remove valve bonnet.</p>	 <p style="text-align: right;">Allen wrench 5mm</p>

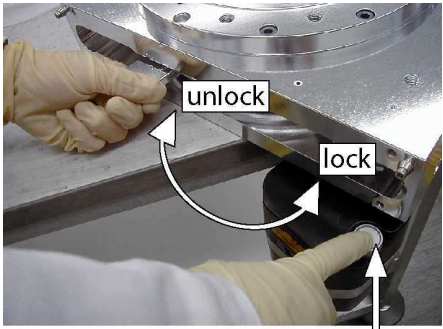
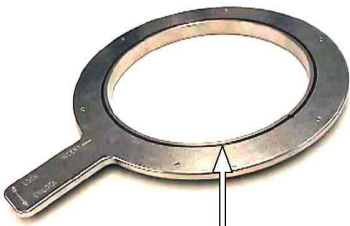

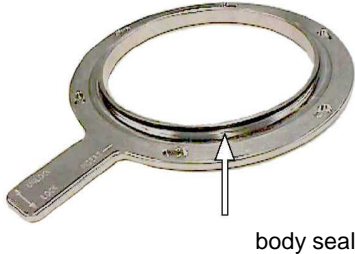
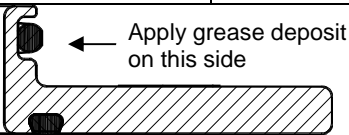
Description	Required tool
<p>5. Open valve</p> <p> Stand away from valve – pendulum plate moves out of the valve body.</p> <p>6. Unfasten mounting screw for pendulum plate.</p> <p>7. Remove pendulum plate.</p>	 <p>pendulum plate</p> <p>mounting screw for pendulum plate</p>
<p>8. With one hand press the MAINTENANCE BUTTON to lower the sealing ring, with your second hand unlock the sealing ring by pressing the handle.</p> <p>9. Release MAINTENANCE BUTTON.</p> <p>10. Remove sealing ring.</p> <p>11. To prevent the shaft and retaining pins from moving during work, switch the valve to safety mode. Refer to «Safety mode» for details.</p> <p> Retaining pins will move up.</p>	 <p>unlock</p> <p>lock</p> <p>maintenance button</p>
<p>12. Remove gate and body o-ring from sealing ring carefully with a soft tool.</p> <p>13. Remove grease residues at sealing ring with alcohol. Clean sealing ring and pendulum plate with alcohol or in an ultrasonic bath.</p> <p>14. Clean out valve body with alcohol. Use an appropriate non metal tool with a cloth to enter valve body. Do not enter valve body with hands! Then blow out valve body with clean air.</p>	 <p>gate seal</p>



Description		Required tool										
<p>Do not directly expose seals (actuator and retaining pin feedthroughs) to air stream!</p> <p>15. Clean or replace gate seal if necessary. Install gate o-ring to sealing ring without grease.</p>	 <p style="text-align: center;">body seal</p>											
<p>16. Clean or replace body seal if necessary. Lubricate body with the quantity of vacuum grease listed in the table to the right.</p>	<table border="1"> <thead> <tr> <th>Valve size</th> <th>Quantity of grease [ml]</th> </tr> </thead> <tbody> <tr> <td>DN 100</td> <td>0.1</td> </tr> <tr> <td>DN 160</td> <td>0.15</td> </tr> <tr> <td>DN 200</td> <td>0.2</td> </tr> <tr> <td>DN 250</td> <td>0.2</td> </tr> </tbody> </table>	Valve size	Quantity of grease [ml]	DN 100	0.1	DN 160	0.15	DN 200	0.2	DN 250	0.2	<p>Soft tool (o-ring remover)</p> <p>Vacuum grease</p>
	Valve size	Quantity of grease [ml]										
	DN 100	0.1										
	DN 160	0.15										
DN 200	0.2											
DN 250	0.2											
<p>17. Install body seal into sealing ring.</p>												
<p>18. Deposit vacuum grease on the bottom side of the body seal according to drawing below. Pay attention that the quantity of vacuum grease listed in the table to the right is distributed constantly over the whole circumference.</p>	<table border="1"> <thead> <tr> <th>Valve size</th> <th>Quantity of grease [ml]</th> </tr> </thead> <tbody> <tr> <td>DN 100</td> <td>0.2</td> </tr> <tr> <td>DN 160</td> <td>0.25</td> </tr> <tr> <td>DN 200</td> <td>0.3</td> </tr> <tr> <td>DN 250</td> <td>0.4</td> </tr> </tbody> </table>	Valve size	Quantity of grease [ml]	DN 100	0.2	DN 160	0.25	DN 200	0.3	DN 250	0.4	<p>Vacuum grease</p>
	Valve size	Quantity of grease [ml]										
	DN 100	0.2										
	DN 160	0.25										
DN 200	0.3											
DN 250	0.4											
		<p>Vacuum grease</p>										
<p>19. Reassembly the valve in reverse order, step 9...3.</p> <p>20. Close the valve bonnet, see steps 31...33.</p>												
<p>21. Mount valve bonnet.</p> <ul style="list-style-type: none"> Tightening torques for bonnet screws, see in table to the right. 	<p style="text-align: center;">Max. torque 6 Nm</p>	<p>Allen wrench 5mm</p>										
<p>22. To leave the maintenance mode press "Restart" button or power cycle the controller.</p> <p>23. Set the valve to remote mode</p>		<p>CPA & Service cable (PC to valve Service connector)</p>										

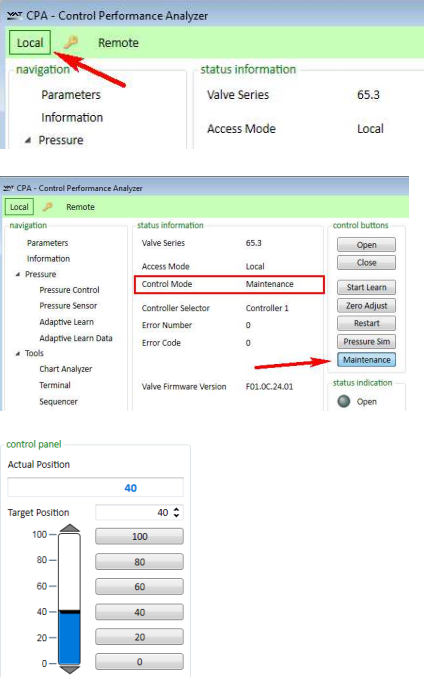

7.2.2 Replacement of actuator shaft seals

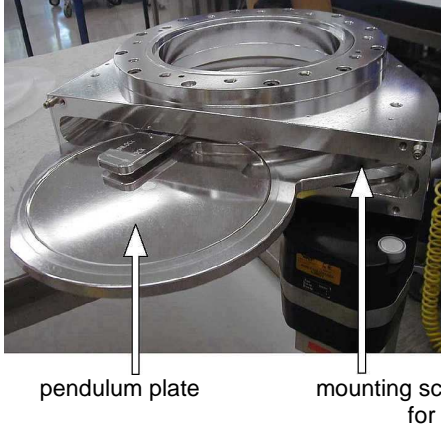

7.2.2.1 Required tools

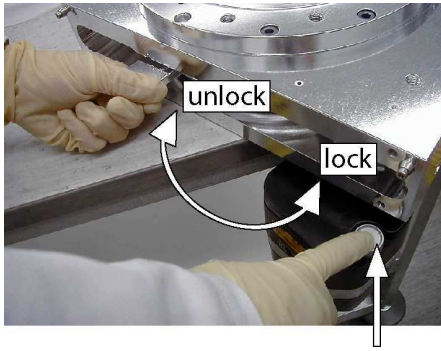

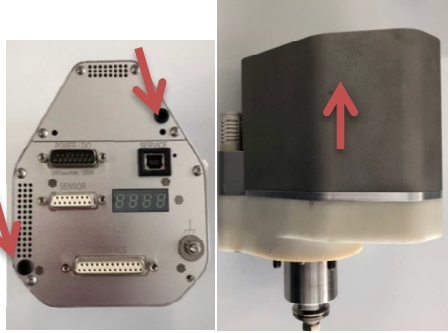
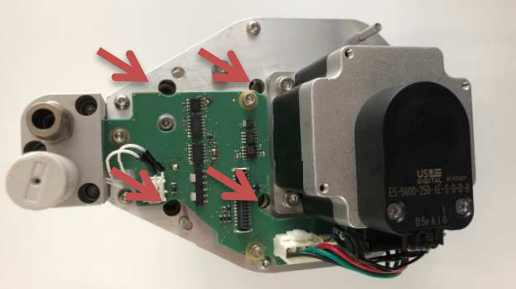

- Allen Wrench 2mm
- Allen Wrench 4mm
- Allen Wrench 5mm
- O-ring removal tool (see chapter Accessories)
- Vacuum grease (see chapter spare parts)
- Open end wrench 13mm
- Clean room wiper
- Isopropyl alcohol
- Service cable USB Type A to B (PC to valve Service connector)

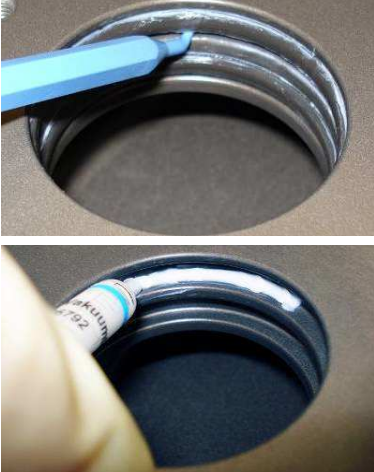
Description	Required tool
 <p>Electrical power and compressed air is required to perform steps 1 to 11 during disassembly respectively 11 to 1 during assembly.</p>	
<p>1. Set the valve to local mode</p> <p>2. Activate "Maintenance" (reduced speed)</p> <p>Now us the position buttons to move the valve plate. The valve will now move in a very low speed</p> <p>Alternatively, the remote interface can be used:</p> <p>Set "Control Mode" to 'Maintenance'</p> <p>Now use "Target Position" to move the valve</p>	 <p>CPA & Service cable (PC to valve Service connector)</p>
<p>3. Vent both valve chambers.</p> <p>4. Open the 4 bonnet screws and remove valve bonnet.</p>	 <p>Allen wrench 5mm</p>

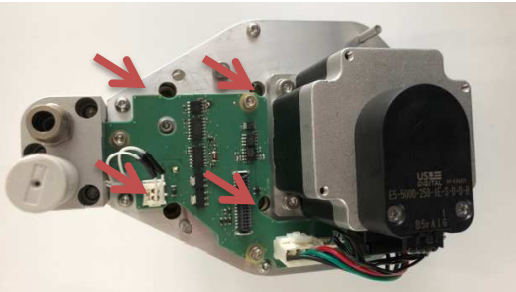
Description	Required tool
<p>5. Open valve</p> <p> Stand away from valve – pendulum plate moves out of the valve body.</p> <p>6. Unfasten mounting screw for pendulum plate.</p> <p>7. Remove pendulum plate.</p>	 <p>pendulum plate</p> <p>mounting screw for pendulum plate</p>
<p>8. With one hand press the MAINTENANCE BUTTON to lower the sealing ring, with your second hand unlock the sealing ring by pressing the handle.</p> <p>9. Release MAINTENANCE BUTTON.</p> <p>10. Remove sealing ring.</p> <p>11. To prevent the shaft and retaining pins from moving during work, switch the valve to safety mode. Refer to «Safety mode» for details.</p> <p> Retaining pins will move up.</p>	 <p>unlock</p> <p>lock</p> <p>maintenance button</p>
<p>12. Release the valve from safety mode. Refer to «Safety mode» for details</p> <p>13. Move the valve to position 50% (half opened) This is necessary, in order to dismantle the actuator. See step 15.</p> <p>14. Disable PFO option feature via 'Power Fail Status' in menu 'System' of CV or CPA software, and turn off the power</p>	<p>• CPA software</p>

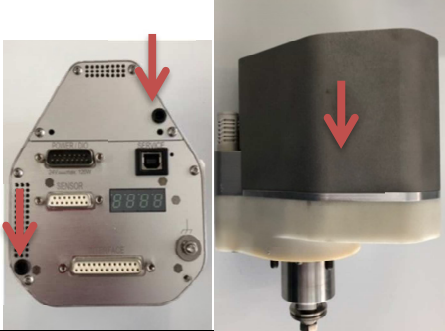
Description	Required tool
<p>15. Disconnect 24VDC power. Wait for 60s, then disconnect cables and compressed air from valve actuator.</p> <p>16. Unfasten all 2 controller screws and lift controller carefully from actuator.</p>	 <p>Allen Wrench 4 mm</p>
<p>17. Unfasten all 4 actuator screws and remove actuator.</p>	 <p>Allen Wrench 5 mm</p>
<p>18. Replace pressed air gasket</p>	 <p>927458</p>

Description	Required tool
<p>19. Remove actuator shaft seals carefully with a soft tool.</p> <p>20. Clean actuator feedthrough with alcohol.</p> <p>21. Lubricate each o-ring groove with 0.1 ml vacuum grease. Pay attention that grease is distributed constantly over the whole circumference.</p>	 <p>Soft tool (o-ring remover)</p> <p>Vacuum grease</p>
<p>22. Clean or replace seals if necessary. Lubricate each o-ring with 0.05 ml vacuum grease.</p> <p>23. Install o-rings.</p> <p>24. Deposit 0.1 ml vacuum grease on each o-ring. Pay attention that grease is distributed constantly over the whole circumference.</p>	 <p>Vacuum grease</p>
<p>25. Remove fixation kit and mounting screw for pendulum plate.</p> <p>26. Clean screw and slightly lubricate thread. Then reinstall fixation kit.</p> <p>27. Clean actuator shaft and lubricate it with 0.1 ml vacuum grease.</p>	 <p>Vacuum grease</p>
<p>28. Install actuator</p> <ul style="list-style-type: none"> • Tighten actuator screws with 10 Nm. • Remove vacuum grease from actuator shaft face after installation. 	 <p>Allen Wrench 5mm</p>

<p>29. Install controller</p> <ul style="list-style-type: none"> • Tighten the controller screws with 3 Nm. • Connect cables at controller • Connect compressed air at actuator 		<p>Allen Wrench 4mm</p>
<p>30. Turn on power of controller.</p> <p> Valve moves to close position.</p> <p>31. Open valve and install sealing ring and pendulum plate in reverse order as they had been disassembled (steps 11 to 2).</p>		<p>open end wrench 13mm</p>
<p>32. Clean the valve sealing surface</p>		<p>Lint-and dust-free towel a little soaked with isopropyl alcohol</p>
<p>33. Clean the valve bonnet o-ring</p>		<p>Lint-and dust-free towel</p>
<p>34. Mount valve bonnet.</p> <ul style="list-style-type: none"> • Tightening torques for bonnet screws, see in table to the right. 	<p>Max. torque 6 Nm</p>	<p>Allen wrench 5mm</p>
<p>35. To leave the maintenance mode press "Restart" button or power cycle the controller.</p> <p>36. Set the valve to remote mode</p>		<p>CPA & Service cable (PC to valve Service connector)</p>

7.2.3 Replacement of Option board

	NOTICE
	<p>Electrostatic discharge</p> <p>Electronic components could be damaged.</p> <p>All work on the control and actuating unit has to be done under ESD protected environment to prevent electronic components from damage.</p>

	NOTICE
	<p>Burned connector pins (spark)</p> <p>Connector pins or electronic parts could be damaged, if plugged and unplugged under power.</p> <p>Do not plug or unplug connectors under power.</p>

The option board may or may not be equipped in your valve depending on the order. Refer to page 1 of this manual to check valve version. This board includes the optional modules for the valve which are:

- ± 15 VDC sensor power supply (SPS)
- Power failure option (PFO)

It is available in 3 versions. These are:

- SPS module only
- PFO module only
- SPS and PFO module

The modules may be retrofitted or replaced easily. The battery lifetime of the PFO module depends on the ambient temperature (see below). To assure PFO function the option board must be replaced after battery life has expired. For ordering number of the modules refer to chapter «Spare parts».

7.2.3.1 Durability of power fail battery

The curves in the graph show the estimated life of Ultra Cap PFO in the worst condition (max. sensor load = 1 A, valve heating temperature = 150 °C).

If the SPS is not fully loaded (< 1 A) or heating temperature of valve body is lower than 150 °C, the corresponding life time curve will be somewhere in between the upper and the lower curve.

Therefore please determine the equivalent maintenance period for replacing the Ultra Cap battery (Option board).

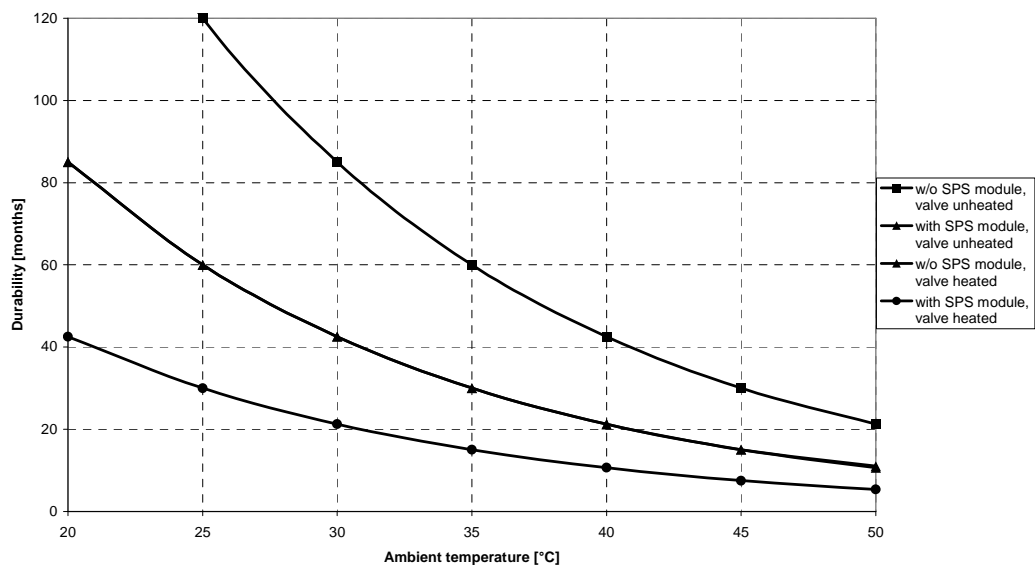

This graph shows estimated life of Ultra Cap PFO for reference and not as guaranteed value.

7.2.4 Retrofit / replacement procedure

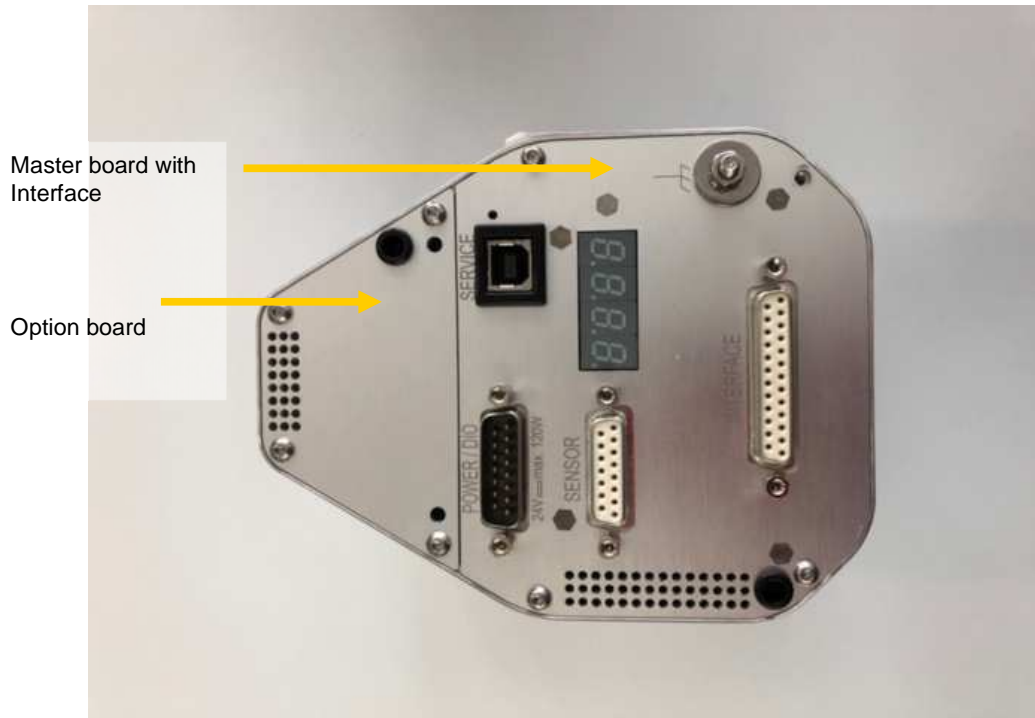

Top view on control and actuating unit with panel removed:



All boards have a fixed position into control and actuating unit. It is not possible to fit a board in other position as shown in picture above! Do not try out other positions, which maybe destroy the socket of boards!

7.2.4.1 Required tools

- Pozidriv screw driver size 1
- Open end wrench 4.5mm

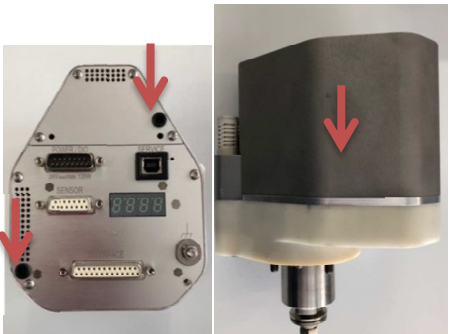
Description	Required tool
<ol style="list-style-type: none"> 1. Disconnect 24VDC power. Wait for 60s, then disconnect cables and compressed air from valve actuator. 2. Unfasten all 2 controller screws and lift controller carefully from actuator. 	
<ol style="list-style-type: none"> 3. Place Option board from behind in the controller. 4. Tighten option board with the 2 screws with 1.1Nm. 	
<ol style="list-style-type: none"> 5. 6. Fasten all 2 controller screws and lift controller carefully from actuator. 7. Connect cables and compressed air to valve actuator. 	



If you need any further information, please contact one of our service centers. You can find the addresses on our website: www.vatvalve.com.

8 Repairs

Repairs may only be carried out by the VAT service staff. In exceptional cases, the customer is allowed to carry out the repairs, but only with the prior consent of VAT.

Please contact one of our service centers. You will find the addresses on our website www.vatvalve.com.

9 Dismounting and Storage

	⚠ WARNING
	Unqualified personnel Inappropriate handling may cause serious injury or property damage. Only qualified personnel are allowed to carry out the described work.

9.1 Dismounting

	NOTICE
	Contamination Gate and other parts of the valve must be protected from contamination. Always wear clean room gloves when handling the valve.

	NOTICE
	Valve in open position Valve body may become damaged if valve gate is in open position. Move valve gate to the closed position before dismantling the valve.

1. Close the valve
2. For dismantling the valve please follow the instructions of chapter: «Installation», however in reverse order.

9.2 Storage

NOTICE	
	<p>Wrong storage</p> <p>Inappropriate temperatures and humidity may cause damage to the product.</p> <p>Valve must be stored at:</p> <ul style="list-style-type: none">– relative humidity between 10% and 70%– temperature between +10 °C and +50 °C– non-condensing environment

NOTICE	
	<p>Inappropriate packaging</p> <p>Product may get damaged if inappropriate packaging material is used.</p> <p>Always use the original packaging material and handle product with care.</p>

1. Clean / decontaminate valve.
2. Cover all valve openings with a protective foil.
3. Pack valve appropriately, by using the original packaging material.

10 Packaging and Transport

	⚠ WARNING
	<p>Unqualified personnel Inappropriate handling may cause serious injury or property damage. Only qualified personnel are allowed to carry out the described work.</p>

	⚠ WARNING
	<p>Harmful substances Risk of injury in case of contact with harmful substances. Remove harmful substances (e. g. toxic, caustic or microbiological ones) from valve before you return the valve to VAT.</p>

	NOTICE
	<p>Inappropriate packaging Product may get damaged if inappropriate packaging material is used. Always use the original packaging material and handle product with care.</p>



- When returning products to VAT, please fill out the VAT form «Declaration of Chemical Contamination of Vacuum Valves and Components» and send it to VAT in advance. The form can be downloaded from our website www.vatvalve.com (Section: Services – Aftersales).
- If products are radioactively contaminated, the VAT form «Contamination and Radiation Report» must be filled out. Please contact VAT in advance.
- If products are sent to VAT in contaminated condition, VAT will carry out the decontaminating procedure at the customer's expense.

10.1 Packaging

	NOTICE
	<p>Valve in open position Valve mechanism may get damaged if valve is in open position. Make sure that the valve is closed.</p>

1. Cover all valve openings with a protective foil.
2. Pack valve appropriately, by using the original packaging material.



VAT disclaims any liability for damages resulting from inappropriate packaging.

10.2 Transport

NOTICE	
	<p>Inappropriate packaging Product may get damaged if inappropriate packaging material is used. Always use the original packaging material and handle product with care.</p>



VAT disclaims any liability for damages resulting from inappropriate packaging.

11 Disposal



WARNING

Unqualified personnel

Inappropriate handling may cause serious injury or property damage.
Only qualified personnel are allowed to carry out the described work.

12 Spare parts



NOTICE

Non-original spare parts

Non-original spare parts may cause damage to the product.
Use original spare parts from VAT only.



- Please specify the fabrication number of the product when you place an order for spare parts; see chapter: «Identification of product». This is to ensure that the appropriate spare parts are supplied.
- VAT makes a difference between spare parts that may be replaced by the customer and those that need to be replaced by the VAT service staff.
- The following table(s) contain spare parts that may be replaced by the customer. If you need any other spare parts, please contact one of our service centers. You will find the addresses on our website www.vatvalve.com.

12.1 Drawing

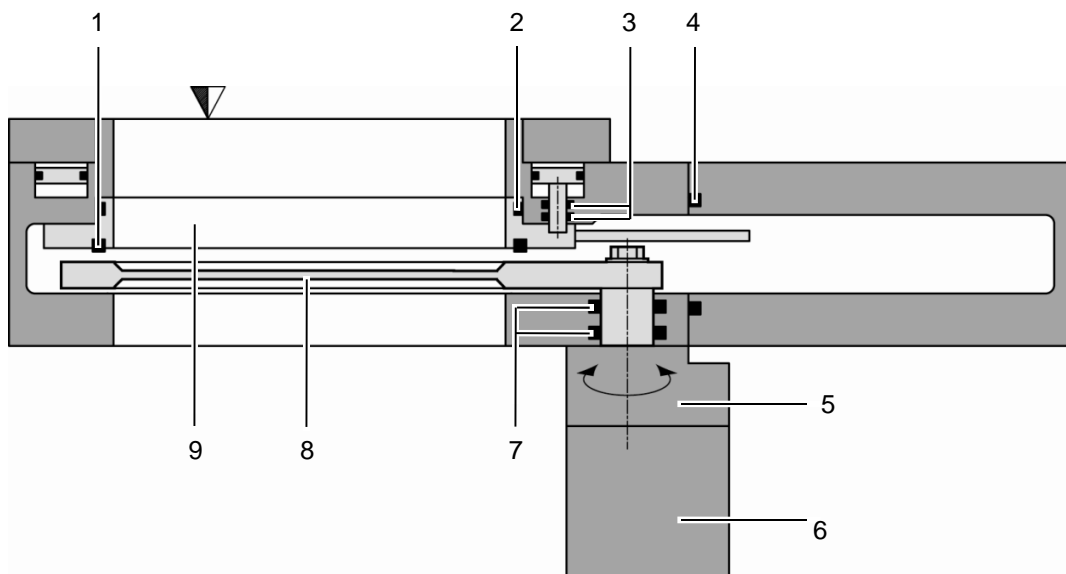

1	Plate seal	6	Integrated controller
2	Body seal	7	Rotary feedthrough seals
3	Shaft feedthrough seals	8	Pendulum plate
4	Bonnet seal	9	Sealing ring
5	Actuator		



All "Item" refer to chapter «Drawing»

12.1.1 Valve unit with seals and grease

Item	Description	DN100	DN160	DN200	DN250
	Valve size Valve part number	DN100 65340 -	DN160 65344 -	DN200 65346 -	DN250 65348 -
1	Bonnet Viton seal other materials	N-5100-259 on request	N-5100-267 on request	N-5100-272 on request	N-5100-277 on request
2	Body seal (Viton) This includes a 2ml syringe of vacuum grease	204884	206527	200468	202592
3	Gate Viton seal other materials	N-5100-155 on request	N-5100-258 on request	N-5100-266 on request	N-5100-275 on request
	Seal kit vacuum (Viton). This consists of item 2 and 3.	204883	206526	204204	203883
	Syringe of 2ml vacuum grease 5ml	206792 206793			
4	Actuator shaft seals (Viton) Actuator compressed air gasket	N-5100-326 (2 pcs required per valve) 927458			
5	Sealing ring shaft seals (Viton)	N-5111-112 (12 pcs required per valve)	N-5111-112 (12 pcs required per valve)	N-5111-112 (16 pcs required per valve)	N-5111-112 (16 pcs required per valve)
6	Pendulum plate: - Blank B1 *) - Blank B2 *) - Hardanodized B1 *) - Hardanodized B2 *) - Nickel coated B1 *) - Nickel coated B2 *)	on request on request on request on request on request on request	on request on request on request on request on request on request	on request on request on request on request on request on request	on request on request on request on request on request on request
7	Sealing ring - Blank - Hardanodized - Nickel coated	on request on request on request	on request on request on request	on request on request on request	on request on request on request
8	Actuator B1 *) B2 *)	on request on request	342943 on request		

*) Refer to figures on next page to check for actuator position options.



Use only spare parts manufactured by VAT to assure safe and reliable operation All "

Actuator position options:

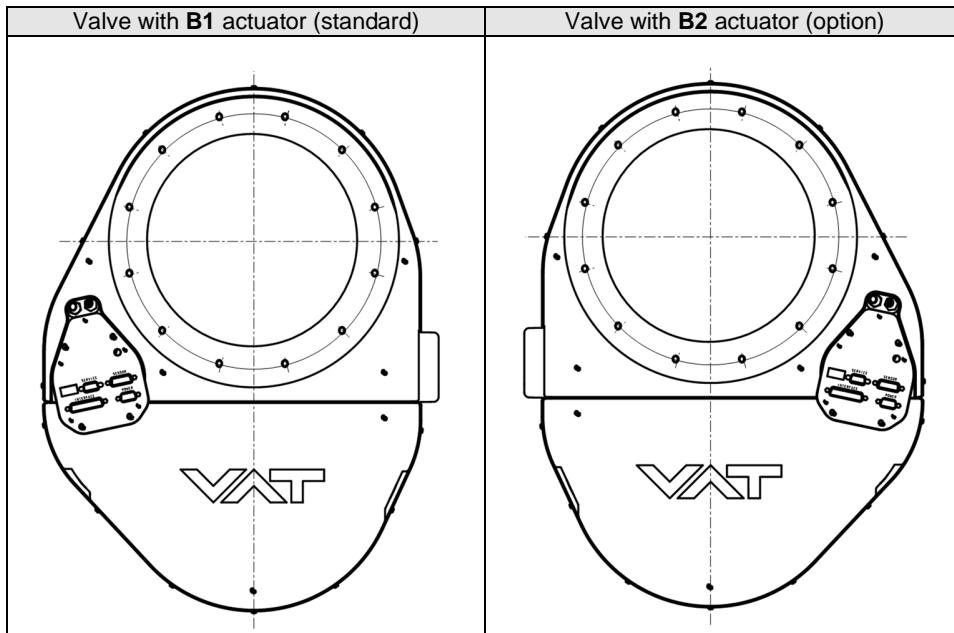

All "Item" refer to chapter «Drawing»

12.1.2 Control and actuating unit

Description	Part number
Control and actuating unit	Too many to list. Please contact VAT.
Option board with SPS module (±15 VDC Sensor Power Supply)	936205
Option board with PFO module (Power Failure Option)	936200
Option board with SPS and PFO module	936202

12.1.3 Accessories

Description	Part number
24 VDC power supply unit (input: 100 – 240 VAC)	891528
O-ring removal tool	234859
VAT valve cleaning tool	305709
Adapter cable for power supply with D-Sub9 connector	(735567) (D-Sub15 to D-Sub9)
Service cable (PC to valve Service connector)	809474 (USB A-B male-male)

12.1.3.1 Centering ring with Viton o-ring

		Description			
Valve size Product ordering number		DN 100 / 4" 65340 -	DN 160 / 6" 65344 -	DN 200 / 8" 65346 -	DN 250 / 10" 65348 -
Centering ring with Viton o-ring (for ISO-F installation only)	Aluminum	32040-QAZV	32044-QAZV	32046-QAZV	32048-QAZV
	Stainless steel	32040-QEZV	32044-QEZV	32046-QEZV	32048-QEZV

13 Appendix

No information entered on time.

This page left blank intentionally.