



RS232 / RS485 / Logic



Ether CAT



Device Net



Valve Cluster Slave  
(without interface)



CC-Link



Profibus



Ether Net

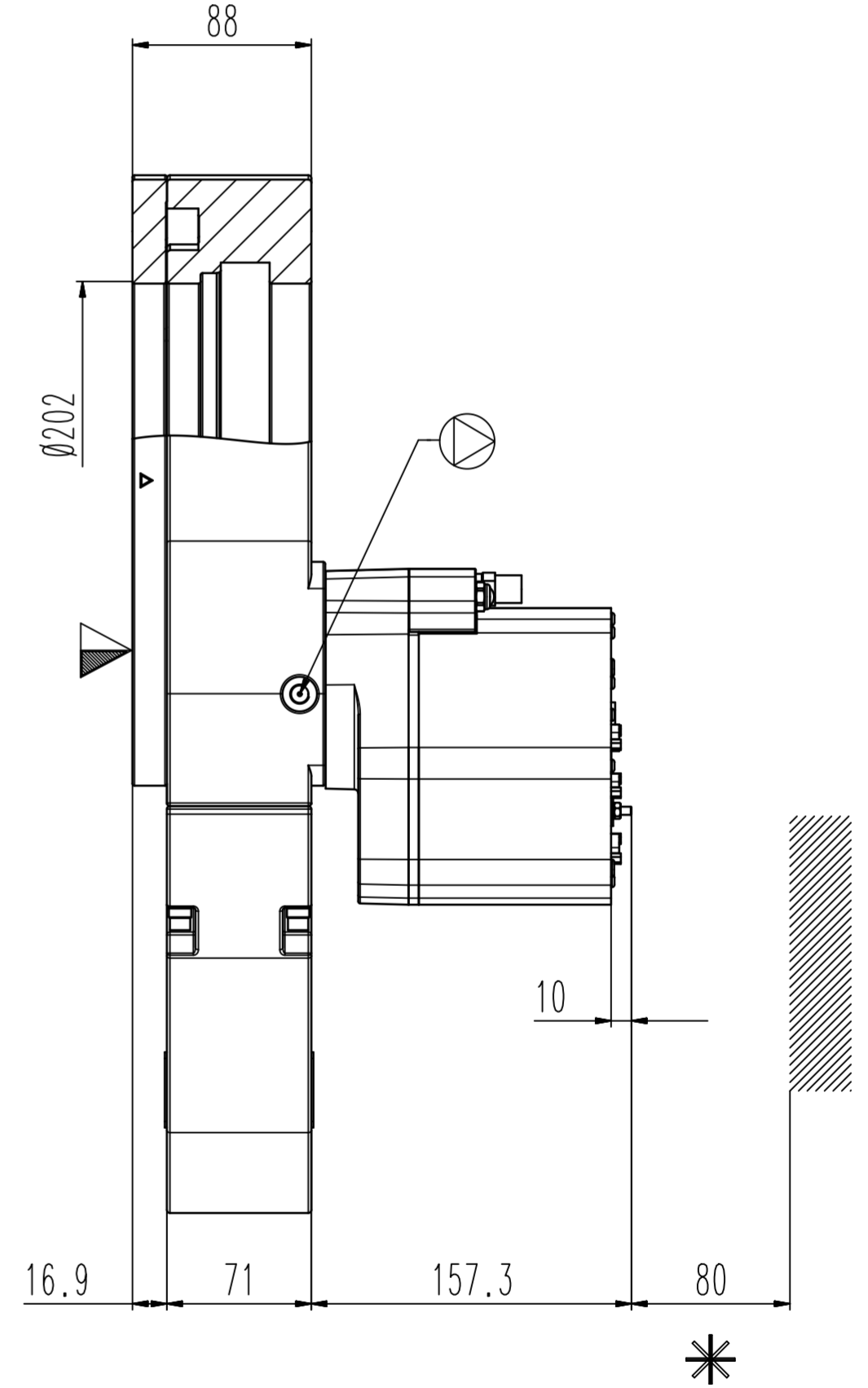
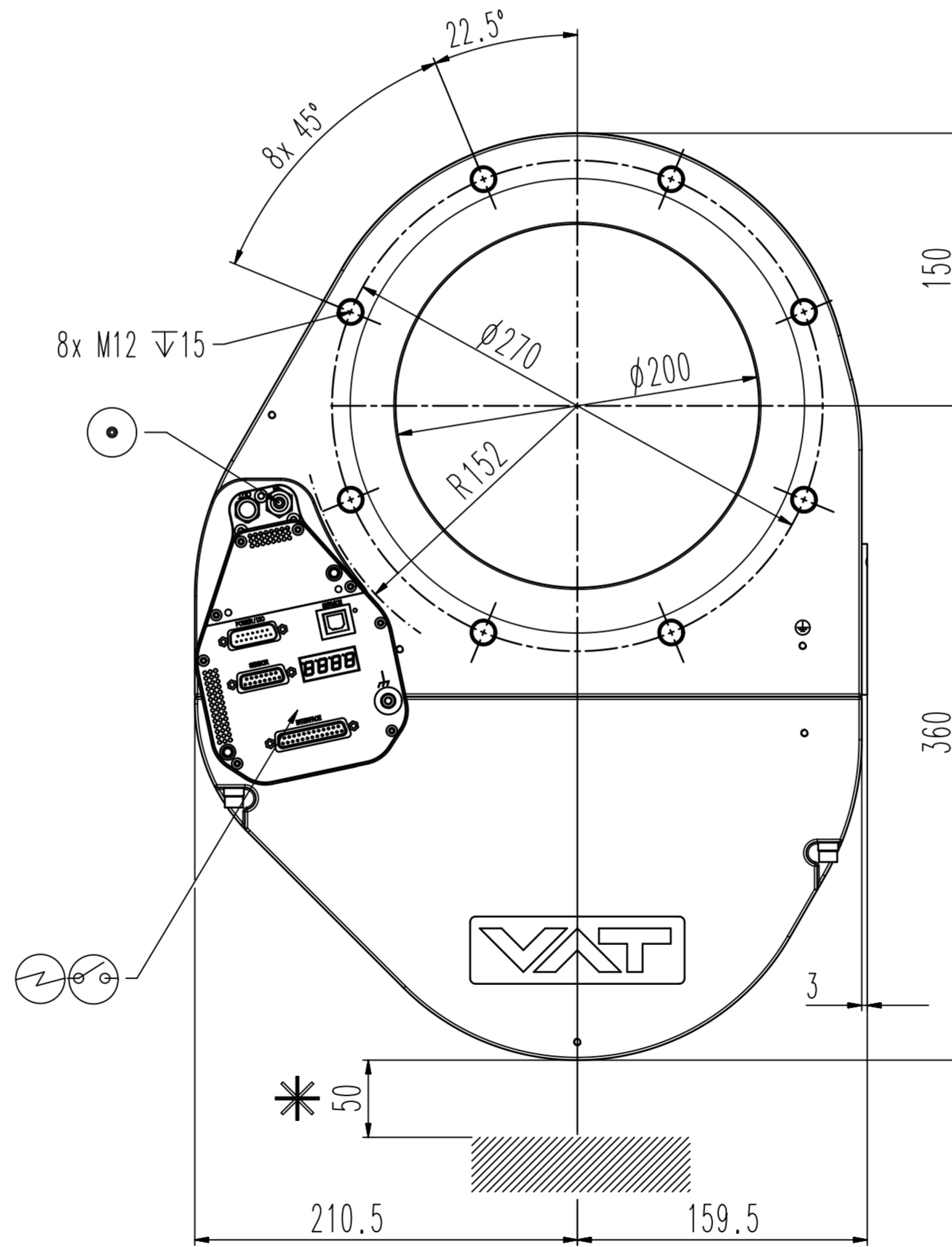
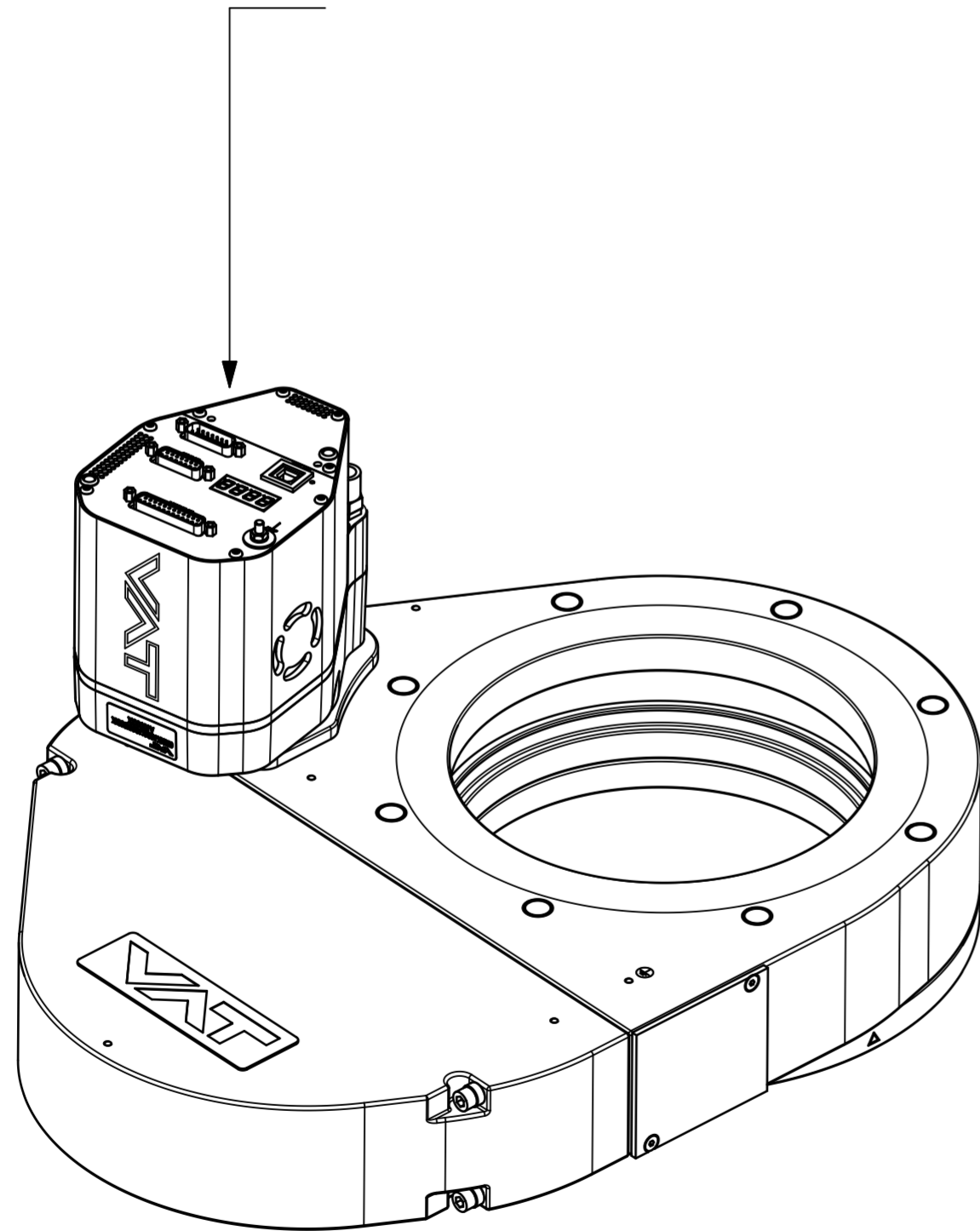

Revision

Customer number

- ▼ Seat side
- ⊙ Comp. air connection
- ⊙ Electrical connection
- ⊙ Leak detection port
- ⊙ Mech. pos. indication
- ⊙ Position indicator
- ⊙ Required for dismantling
- ⊙ Emergency actuation
- ⊙ For attachment
- ⊙ Bake-out area
- ⊙ Differential pumping port

Control pendulum valve

**VAT** VAT Vakuumventile AG  
CH-9469 Haag, Switzerland  
Tel: ++41 81 7716161 Fax: ++41 81 7714830

Rev.-Date: 26.06.24  
Visa: TANK

Series	653	Ordering No.	JIS Std
Projection E	DN	Flange	
	200		
Dimensional Drawing	1297240	Rev.	A