

Installation, Operating & Maintenance Instructions



Pendulum control & isolation valve with Logic interface

Series 653 DN 100-250 mm (I.D. 4" - 10")

This manual is valid for the valve ordering number(s):

- 653GE - (2 sensor inputs / analog outputs)
- 653AE - (2 sensor inputs / analog outputs / $\pm 15V$ SPS)
- 653HE - (2 sensor inputs / analog outputs / PFO)
- 653CE - (2 sensor inputs / analog outputs / $\pm 15V$ SPS / PFO)

SPS = Sensor Power Supply PFO = Power Failure Option

configured with firmware: F01.0C.28.xx

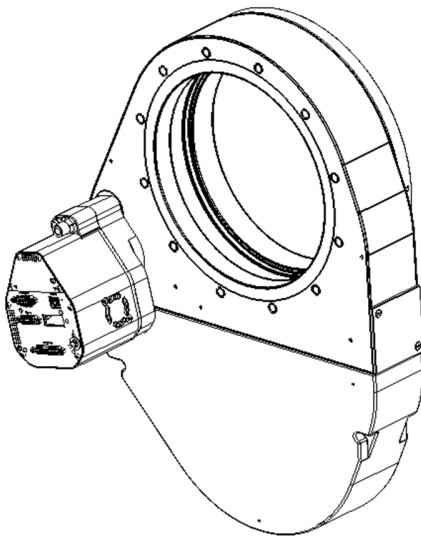

Sample picture

Imprint

Manufacturer VAT Vakuumventile AG, CH-9469 Haag, Switzerland

Website: www.vatvalve.com

Phone: +41 81 771 61 61

Fax: +41 81 771 48 30

Email: CH@vatvalve.com

Publisher VAT Vakuumventile AG, CH-9469 Haag, Switzerland

Editor VAT Vakuumventile AG, CH-9469 Haag, Switzerland

Print VAT Vakuumventile AG, CH-9469 Haag, Switzerland

Copyright © VAT Vakuumventile AG 2019

No part of these instructions may be reproduced in any way (photocopies, microfilms or any other reproduction processes) nor may it be manipulated with electronic systems, duplicated or distributed without written permission from VAT. Offenders are liable to pay damages.

The original VAT firmware and updated state of the art versions of the VAT firmware are intended for use with VAT products. The VAT firmware contains a limited, time unlimited user license. The VAT firmware may not be used for purposes other than those intended nor is it permitted to make copies of the VAT firmware. In particular, it is strictly forbidden to give copies of the VAT firmware to other people.

The use of trade names, brand names, trademarks, etc. in these Instructions does not entitle third parties to consider these names to be unprotected and to use them freely. This is in accordance with the meaning of the laws and acts covering brand names and trademarks.

Contents

1	Description of product.....	5
1.1	Identification of product	5
1.2	Use of product	5
1.3	Used abbreviations.....	5
1.4	Related documents.....	5
1.5	Important information.....	5
1.6	Technical data	6
1.6.1	Control and actuating unit	6
1.6.2	Valve unit	9
2	Safety	11
2.1	Compulsory reading material.....	11
2.2	Danger levels	11
2.3	Personnel qualifications.....	12
2.4	Safety labels.....	12
3	Design and Function.....	13
3.1	Design	13
3.2	Function.....	14
3.2.1	Pressure control system overview and function	15
3.2.2	Principle of a pressure control system	16
4	Installation	17
4.1	Unpacking	17
4.2	Installation into the system	18
4.2.1	Installation space condition	19
4.2.2	Connection overview.....	20
4.2.3	Installation procedure.....	21
4.2.4	Tightening torque	22
4.2.5	Mounting with centering rings	22
4.2.6	Mounting with O-ring in grooves	23
4.2.7	Admissible forces.....	24
4.2.8	Requirements to sensor connection.....	24
4.3	Electrical connection.....	25
4.3.1	Ground connection.....	26
4.3.2	Power and Sensor supply concepts.....	27
4.3.3	Digital Input/Output and analogue output connections.....	33
4.3.4	Connection with switches over power supply connector	33
4.3.5	Service port connection.....	34
4.3.6	Functions and Wiring	35
4.3.7	Digital inputs	37
4.3.8	Digital outputs	39
4.3.9	Analog inputs and outputs.....	40
4.4	Initial operation	41
4.5	Scaling of Pressure and Position Values.....	42
4.6	Configuration through CPA.....	43
4.6.1	Logic Interface configuration	43
4.6.1	Homing Start Option	43
4.6.2	Power Failure Option	44
4.6.3	Digital I/O	44
4.7	Sensor configuration.....	45
4.7.1	Sensor configuration	45
4.7.2	Zero Adjust.....	48
4.8	Learn (adaptive control algorithm).....	50
4.9	Pressure Control	52

4.9.1	Pressure control operation with 2 sensors	53
4.9.2	Control parameters.....	54
4.9.3	Choose correct control algorithm.....	58
4.9.4	Tuning of control performance	59
5	Operation.....	69
5.1	Normal operation	69
5.1.1	Remote operation.....	69
5.1.2	Local operation.....	70
5.2	Close valve.....	71
5.3	Open valve.....	71
5.4	Position control	71
5.5	Pressure control.....	71
5.6	Display information	72
5.6.1	Power up	72
5.6.2	Operation	73
5.6.3	Error	73
5.6.4	Safety mode	73
5.7	Operation during power up	74
5.8	Behavior in case of power failure.....	74
5.9	Operation under increased temperature	75
5.10	Behavior In case of compressed air pressure drop.....	75
6	Trouble shooting	76
6.1.1	Controller Display	76
6.1.2	Error numbers	76
6.1.3	Error code	76
7	Maintenance	78
7.1	Maintenance intervals.....	78
7.2	Maintenance procedures	79
7.2.1	Replacement of isolation seals and valve cleaning.....	80
7.2.2	Replacement of actuator shaft seals	83
7.2.3	Replacement of Option board	88
7.2.4	Retrofit / replacement procedure.....	90
8	Repairs	92
9	Dismounting and Storage	93
9.1	Dismounting.....	93
9.2	Storage	94
10	Packaging and Transport.....	95
10.1	Packaging.....	95
10.2	Transport	96
11	Disposal.....	97
12	Spare parts.....	98
12.1	Drawing	98
12.1.1	Valve unit with seals and grease.....	99
12.1.2	Control and actuating unit	100
12.1.3	Accessories.....	101
13	Appendix	102

1 Description of product

1.1 Identification of product

The fabrication number and order number are fixed on the product directly or by means of an identification plate.

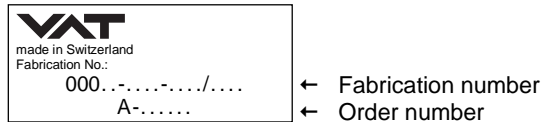

1.2 Use of product

This product is a throttling pendulum valve with isolation functionality. It is intended to use for downstream pressure control applications.

Use product for clean and dry vacuum applications only. Other applications are only allowed with the written permission of VAT.

1.3 Used abbreviations

Abbreviation	Description
CPA	Control Performance Analyzer
PFO	Power Failure Option
SFS	Sensor Full Scale
SPS	Sensor Power Supply
ADC	Analog-to-digital converter

1.4 Related documents

- Product Data Sheet
- Dimensional Drawing
- IOMI Heating device (if valve with heater)

1.5 Important information



This symbol points to a very important statement that requires particular attention.

Example:



Refer to chapter: «Technical data» for detailed information.

1.6 Technical data

1.6.1 Control and actuating unit

Description	
Power input ¹⁾ (α) [653 A / 653 H] [653 C / 653 H]	+24 VDC ($\pm 10\%$) @ 0.5 V pk-pk max. [connector: POWER] 70 W max. (operation of valve with max. load) without PFO ³⁾ with optional SPS + 40 W with optional PFO + 10 W ³⁾
Sensor power supply ²⁾ (β) [653 A / 653 C] Input Output	+24 VDC / 1500 mA max. [connector: POWER] ± 15 VDC ($\pm 5\%$) / 1200 mA max. [connector: SENSOR]
Sensor power supply ²⁾ (β) [653 G / 653 H] Input Output	+ 24 VDC resp. ± 15 VDC [connector: POWER] same as input but: [connector: SENSOR] 2.0 A max. at ± 15 VDC 1.5 A max. at + 24 VDC
Actuator type	Stepper motor with servo control
Ingress Protection	IP30

¹⁾ Internal overcurrent protection by a PTC device.

²⁾ Refer to chapter «Sensor supply concepts» for details.

³⁾ PFO = Power Failure Option. Refer to «Behavior in case of power failure» for details.



Calculation of complete power consumption:

$$P_{\text{tot}} = \alpha + \beta$$

whereas β depends on sensor supply concept and sensor power consumption.

Control and actuating unit (continuation)		
Sensor input Signal input voltage ADC resolution Sampling time	-10 ... +10 V / $R_i = 100 \text{ k}\Omega$ 0.1 mV 2 ms	[connector: SENSOR]
Digital inputs (power connector) input 1 input 2 voltage control contact control	interlock open (adjustable with CPA 4.0) interlock close (adjustable with CPA 4.0) 12 ... 24V / 4 ... 8 mA 24V / 8 mA	[connector: POWER] [connector: POWER]
Digital outputs (power connector) output 1 output 2 load	valve closed (adjustable with CPA 4.0) valve opened (adjustable with CPA 4.0) max. 70 V / 0.1 A	[connector: POWER] [connector: POWER]
Digital inputs ⁴⁾ voltage control contact control	5 ... 24V / 2 ... 10 mA 3.3V / 2 mA	[connector: INTERFACE]
Digital outputs ⁴⁾ Input voltage Input current	max. 70 V max. 0.1 A	[connector: INTERFACE]
Analog outputs ⁴⁾	0-10 VDC / 1 mA max.	[connector: INTERFACE]
PFO ⁵⁾ battery pack [653 C / 653 H] Charging time Durability	2 minutes max. up to 10 years @ 25°C ambient; refer to «Durability of power fail battery» for details	
Compressed air supply	4 - 7 bar / 55 - 100 psi (above ATM)	
Ambient temperature	0 °C to +50 °C max. (<35 °C recommended)	
Pressure control accuracy	5 mV or 0.1% of setpoint, whichever is greater	

	DN 100 4" (65340 -)	DN 160 6" (65344 -)	DN 200 8" (65346 -)	DN 250 10" (65348 -)
Position resolution / position control capability	58000 steps (full stroke)			
Closing time throttling only (full stroke)	0.7 s typ. 0.4 s typ.	0.8 s typ. 0.45 s typ.	0.9 s typ. 0.5 s typ.	0.9 s typ. 0.5 s typ.
Opening time throttling only (full stroke)	0.7 s typ. 0.4 s typ.	0.8 s typ. 0.45 s typ.	0.9 s typ. 0.5 s typ.	0.9 s typ. 0.5 s typ.
Closing time throttling & isolation (full stroke)	3 s typ.	3 s typ.	3 s typ.	3 s typ.
Opening time throttling & isolation (full stroke)	4 s typ.	4 s typ.	4 s typ.	4 s typ.

⁴⁾ Refer to chapter «Schematics» for details.

⁵⁾ PFO = Power Failure Option. Refer to chapter «Behavior in case of power failure» for details.

1.6.2 Valve unit

Description	
Pressure range at 20°C	
- Aluminum (653 A)	1 × 10E-8 mbar to 1.2 bar (abs)
- Aluminum hard anodized (653 H)	1 × 10E-6 mbar to 1.2 bar (abs)
- Aluminum nickel coated (653 I)	1 × 10E-8 mbar to 1.2 bar (abs)
Leak rate to outside at 20°C	
- Aluminum (653 A)	1 × 10E-9 mbar l/s
- Aluminum hard anodized (653 H)	1 × 10E-5 mbar l/s
- Aluminum nickel coated (653 I)	1 × 10E-9 mbar l/s
Leak rate valve seat at 20°C	
- Aluminum (653 A)	1 × 10E-9 mbar l/s
- Aluminum hard anodized (653 H)	1 × 10E-4 mbar l/s
- Aluminum nickel coated (653 I)	1 × 10E-9 mbar l/s
Cycles until first service	
- Isolation cycles (open - closed - open)	200'000 (unheated and under clean conditions)
- Throttling cycles (open - max. throttle - open)	1'000'000 (unheated and under clean conditions)
Admissible operating temperature	+10°C to +120°C
Mounting position	horizontally only
Wetted materials	
- Body (653 A)	Aluminum 3.3211 (AA6061)
- Body (653 H)	Aluminum 3.3211 (AA6061) hard anodized
- Body (653 I)	Aluminum 3.3211 (AA6061) nickel coated
- Pendulum plate (653 A)	Aluminum 3.3211 (AA6061)
- Pendulum plate (653 H)	Aluminum 3.3211 (AA6061) hard anodized
- Pendulum plate (653 I)	Aluminum 3.3211 (AA6061) nickel coated
- Sealing ring (653 A)	Aluminum 3.3211 (AA6061), 1.4306 (304L)
- Sealing ring (653 H)	Aluminum 3.3211 (AA6061) hard anodized, 1.4306 (304L)
- Sealing ring (653 I)	Aluminum 3.3211 (AA6061) nickel coated, 1.4306 (304L)
- Other parts	Stainless steel 316L (1.4404 or 1.4435), 1.4122, 1.4310 (301), 1.4303 (304), 1.4571, A2 (304)

Description				
- Seals	Viton® (standard). Other materials available. Seal materials are declared on dimensional drawing of specific valve ordering number.			
	DN 100 4" (65340 -)	DN 160 6" (65344 -)	DN 200 8" (65346 -)	DN 250 10" (65348 -)
Max. differential pressure on plate during isolation	1200 mbar in either direction	1200 mbar in either direction	1200 mbar in either direction	1200 mbar in either direction
Max. differential pressure on plate during opening and throttling	30 mbar	10 mbar	5 mbar	5 mbar
Min. controllable conductance (N ₂ molecular flow)	Typ. 2 l/s	Typ. 4 l/s	Typ. 7 l/s	Typ. 10 l/s
Dimensions	Refer to dimensional drawing of specific valve ordering number (available on request)			

2 Safety

2.1 Compulsory reading material

Read this chapter prior to performing any work with or on the product. It contains important information that is significant for your own personal safety. This chapter must have been read and understood by all persons who perform any kind of work with or on the product during any stage of its serviceable life.

	NOTICE
	<p>Lack of knowledge</p> <p>Failing to read this manual may result in property damage. Firstly, read manual.</p>





These Installation, Operating & Maintenance Instructions are an integral part of a comprehensive documentation belonging to a complete technical system. They must be stored together with the other documentation and accessible for anybody who is authorized to work with the system at any time.

2.2 Danger levels



	⚠ DANGER
	<p>High risk</p> <p>Indicates a hazardous situation which, if not avoided, will result in death or serious injury.</p>

	⚠ WARNING
	<p>Medium risk</p> <p>Indicates a hazardous situation which, if not avoided, could result in death or serious injury.</p>

	⚠ CAUTION
	<p>Low risk</p> <p>Indicates a hazardous situation which, if not avoided, may result in minor or moderate injury.</p>

	NOTICE
	<p>Command</p> <p>Indicates a hazardous situation which, if not avoided, may result in property damage.</p>

2.3 Personnel qualifications

	 WARNING
	<p>Unqualified personnel Inappropriate handling may cause serious injury or property damage. Only qualified personnel are allowed to carry out the described work.</p>

2.4 Safety labels

Label	Part No.	Location on valve
	T-9001-156	On protective foil covering of valve opening

3 Design and Function

3.1 Design

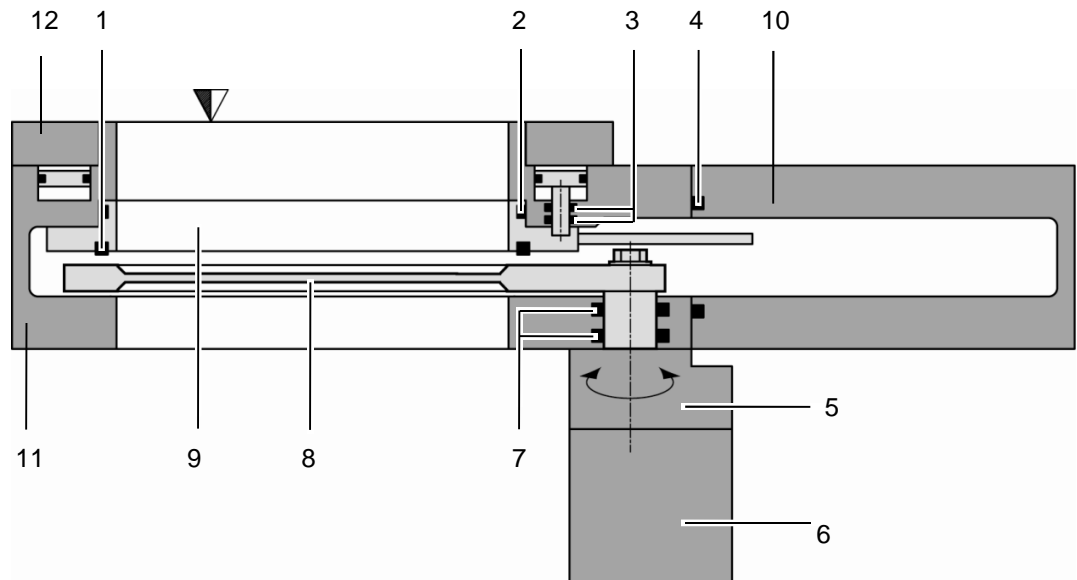

1	Plate seal	7	Rotary feed through seals
2	Body seal	8	Pendulum plate
3	Shaft feed through seals	9	Sealing ring
4	Bonnet seal	10	Bonnet
5	Actuator	11	Body
6	Integrated controller	12	Body Flange

3.2 Function

The valve plate acts, due to its pendulum motion, as a throttling element and varies the conductance of the valve opening. The integrated controller calculates the required plate position to achieve the set point pressure. Actuation is performed by a stepper motor. An encoder monitors the position. This principle ensures fast and accurate process pressure control.

For opening or control the "sealing ring" is lifted pneumatically by "compressed air", afterwards the "pendulum plate" moves to open or do pressure control. For leak tight closing, the "sealing ring" moves downwards and press the pendulum plate to valve body for "isolation". Closing is performed by "springs".

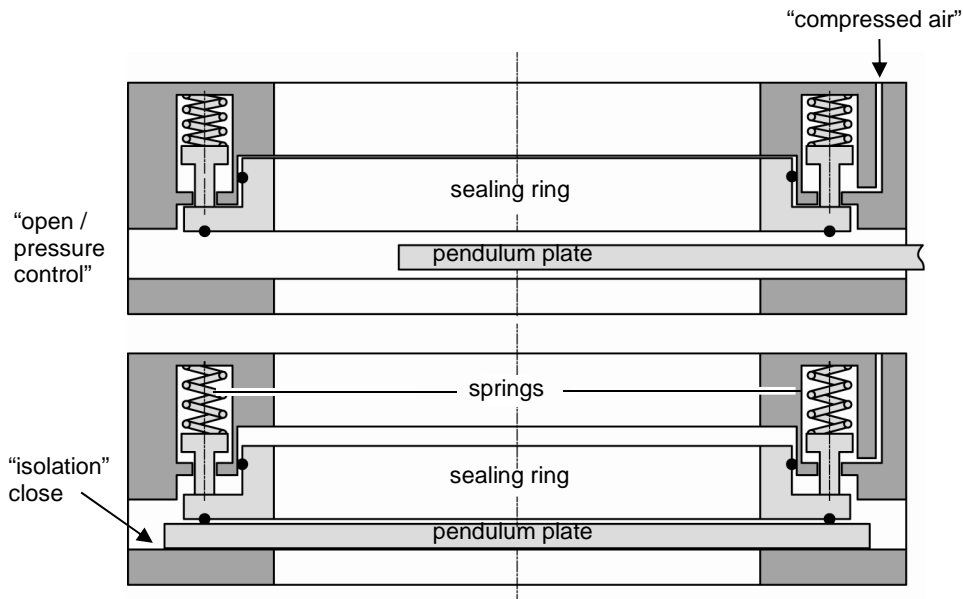

3.2.1 Pressure control system overview and function

Vacuum pressures are always absolute pressures unless explicitly specified as pressure differences.

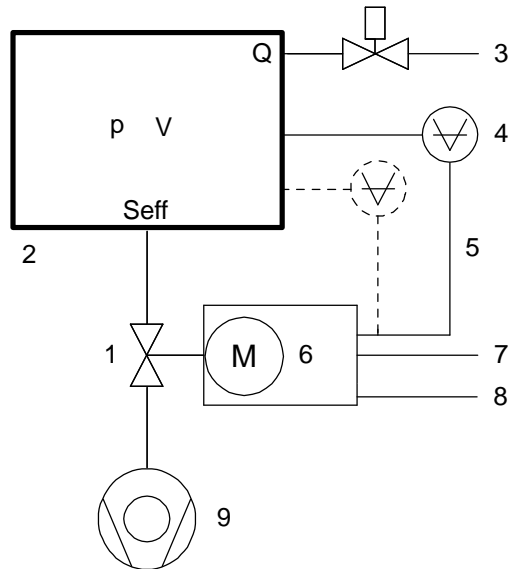

- 1 Valve
- 2 Process chamber
- 3 Gas inlet
- 4 Pressure sensor(s)
- 5 Sensor cable
- 6 Controller and actuator
- 7 Cable to remote control unit
- 8 Cable to power supply
- 9 HV Pump

$$S_{eff} = Q / p$$

S_{eff} effective pump speed ($l s^{-1}$)

Q Gas flow ($mbar l s^{-1}$)

p Pressure (mbar)

or units used in USA

$$S_{eff} = 12.7 \cdot Q / p$$

S_{eff} effective pump speed ($l s^{-1}$)

Q Gas flow (sccm)

p Pressure (mTorr)

V Volume

Example: Downstream control

3.2.1.1 Way of operation

The controller compares the actual pressure in the process chamber given by the pressure sensor with the preset pressure. The controller uses the difference between actual and set pressure to calculate the correct position of the control valve. The controller drives the control valve into the correct position and the actual pressure again equals the set pressure. This control operation is performed continuously. Pressure changes in the process chamber due to leaks, desorption, and gas flow, reaction products, variations in pumping speed etc. are always corrected at once.

3.2.1.2 Pressure control

In a vacuum system which is pumped and into which gas is admitted at the same time, the pressure can be controlled in two ways:

1. Downstream control (standard):
The pressure is controlled by changing the conductance of a control valve between pump and process chamber. This changes the effective pumping speed at the process chamber. Pressure and gas flow can be independently controlled over a wide range.
2. Upstream control:
The pressure is controlled by changing the gas flow into the process chamber, while the pumping speed remains constant.

3.2.1.3 Adaptive controller (standard)

A controller adapting itself to changes in pressure, gas flow and pumping system without any manual adjustments. This allows for a completely automatic operation of the system.

3.2.2 Principle of a pressure control system

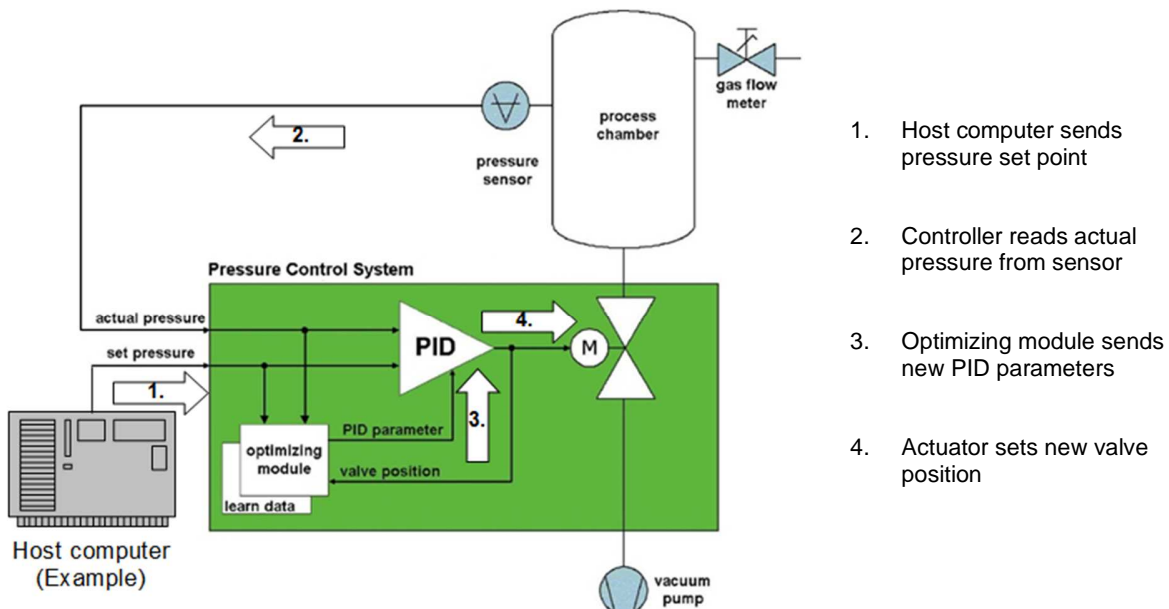

4 Installation

	⚠ WARNING
	<p>Unqualified personnel Inappropriate handling may cause serious injury or property damage. Only qualified personnel are allowed to carry out the described work.</p>

4.1 Unpacking

	NOTICE
	<p>Physical overstraining at controller Inappropriate handling with the valve may cause in damage of controller. Do not place the valve on the controller.</p>

	⚠ CAUTION
	<p>Valve is a heavy component Physical overstraining. Use a crane to lift valves DN 200 (8") and larger.</p>









- Make sure that the supplied products are in accordance with your order.
- Inspect the quality of the supplied products visually. If it does not meet your requirements, please contact VAT immediately.
- Store the original packaging material. It may be useful if products must be returned to VAT.

1. Open the transport case and remove inside packing material as far as necessary.
2. Attach lifting device for valves DN 200 (8") and larger. For attachment refer to dimensional drawing of valve.
3. Lift the valve carefully and place it on a clean place.



Do not remove protective foils from valve opening

4.2 Installation into the system

	<p style="text-align: center;">⚠ WARNING</p> <p>Valve opening Risk of serious injury. Human body parts must be kept out of the valve opening and away from moving parts. Do not connect the controller to power before the valve is installed complete into the system.</p>
	<p style="text-align: center;">⚠ WARNING</p> <p>Valve in open position Risk of injury when compressed air is connected to the valve. Connect compressed air only when: – valve is installed in the vacuum system – moving parts cannot be touched</p>
	<p style="text-align: center;">NOTICE</p> <p>Sealing surfaces Sealing surfaces of valve and vacuum system could be damage in case of incorrect handling. Only qualified personal are allowed to install the valve into the vacuum system.</p>
	<p style="text-align: center;">NOTICE</p> <p>Wrong connection Wrong connection may result in damage of controller or power supply. Connect all cables exactly as shown in the following descriptions and schematics.</p>
	<p style="text-align: center;">NOTICE</p> <p>Burned connector pins (spark) Connector pins or electronic parts could damage, if plugged and unplugged under power. Do not plug or unplug connectors under power.</p>
	<p style="text-align: center;">NOTICE</p> <p>Contamination Gate and other parts of the valve must be protected from contamination. Always wear clean room gloves when handling the valve.</p>



Mount valve to a clean system only.

4.2.1 Installation space condition



Install the valve with integrated controller with space for dismantling and air circulation as shown in figure below.

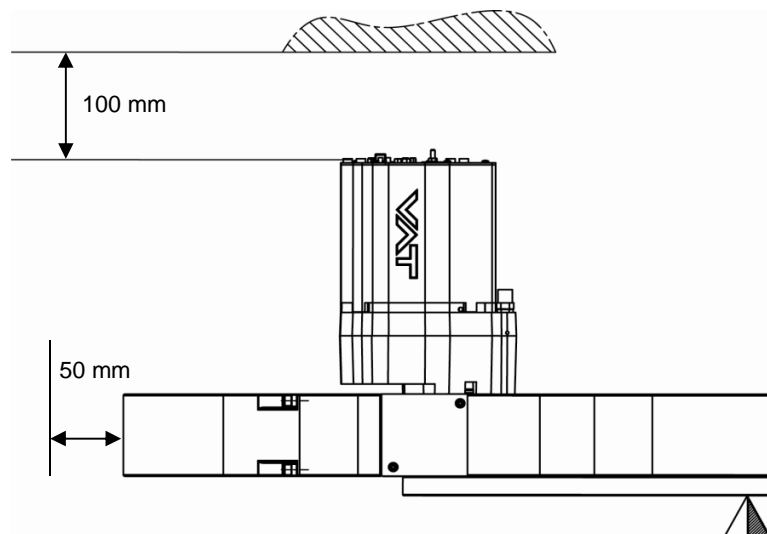

4.2.2 Connection overview

System:

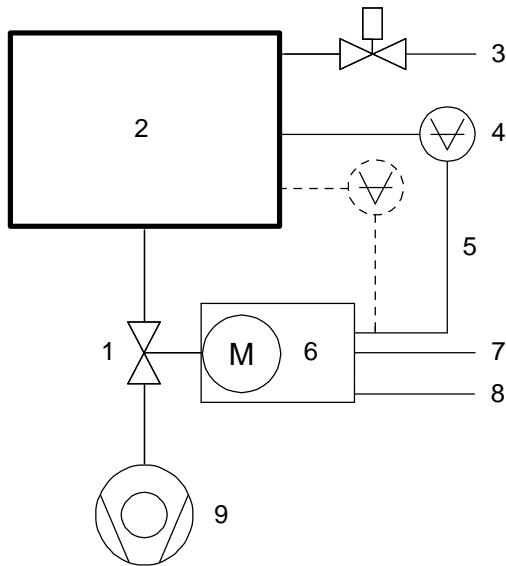

- 1 Valve
- 2 Process chamber
- 3 Gas inlet
- 4 Pressure sensor(s)
- 5 Sensor cable(s)
- 6 Controller and actuator
- 7 Cable to remote control unit
- 8 Cable to power supply
- 9 Pump

Controller:

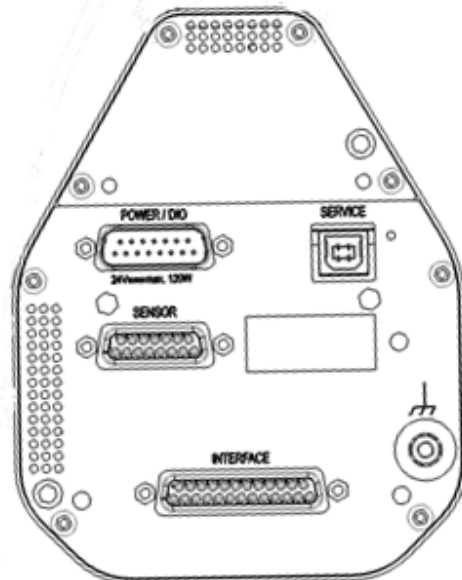

4.2.3 Installation procedure

1. Install valve [1] into the vacuum system. Valve seat side should face process chamber. The valve seat side is indicated by the symbol "∇" on the valve flange.



- Do not tighten the flange screws stronger than indicated under «Tightening torque».
- Do not admit higher forces to the valve than indicated under «Admissible forces».
- Make sure that enough space is kept free to do preventive maintenance work. The required space is indicated on the dimensional drawing.

2. Connect compressed air supply to connection labeled '**IN**' located at actuator, see Figure 1 below. Connect compressed air return line connection labeled '**OUT**' located at actuator, see Figure 1 below.



- Compressed air pressure must be in the range of: **4 - 7 bar / 55 - 100 psi (above ATM)**.
- Use only clean, dry or slightly oiled air. IN / OUT connections are 1/8" ISO/NPT internal threads.

3. Install the ground connection cable at controller. Refer to «Electrical connection»
4. Install pressure sensor(s) [2] according to the recommendations of the sensor manufacturer and directives given under «Requirements to sensor connection».
5. Connect sensor cable [3] to sensor(s) and then to valve (connector: SENSOR). Refer to chapter «Electrical connection» for correct wiring.
6. Connect valve to interface [4] (connector: INTERFACE). Refer to «Function and Wiring» for correct wiring.
7. Connect power supply [5] to valve (connector: POWER). Refer to chapter «Electrical connection» for correct wiring.



To provide power to the valve motor pins 4 and 11 must be bridged, otherwise motor interlock is active and the valve enters the safety mode and is not operative. Refer also to «Safety mode».

8. This valve has a double sealed rotary feedthrough and optionally an intermediate pumping port for the actuator shaft. This port (1/8" ISO/NPT) could be connected to the vacuum line, see Figure 3 below.
9. This valve may optionally be equipped with a heating device. Connect VAT heating device according to manual of respective heating device.

10. Perform «Setup procedure» to prepare valve for operation.



Without performing the setup procedure the valve will not be able to do pressure control.

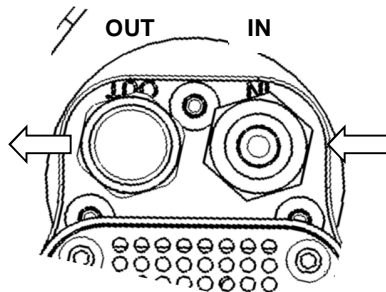

Fig. 1



Fig. 2

4.2.4 Tightening torque



The torque values below are dependent on many factors, such as materials involved, surface quality, surface treatment, and lubrication.

The torques below are valid if immersion depth of the mounting screws is at least once the thread diameter (min. 1d), and the friction coefficient of the screw-flange connection ($\mu_{total} = (\mu_{screw\ thread-helicoil} + \mu_{under\ screw\ head})/2$) is bigger than 0.12. Lower friction coefficients may damage the valve, as the resulting preload force gets too high. Therefore for other friction coefficients the torque needs to be adapted. Please review design guidelines for Helicoil-Screw connections and make sure that screws in use are capable to withstand applied torques, are appropriate for the application and are not too long. Too long screws may damage the valve, the immersion depth should not exceed (hole depth – 1 mm).

Tighten mounting screws of the flanges uniformly in crosswise order. Observe the maximum torque levels in the following tables.

4.2.5 Mounting with centering rings

Valve size (65340 -)	ISO-F	ISO-F
	max. tightening torque (Nm)	max. tightening torque (lbs . ft)
DN100 / 4" (65340 -)	8-10	6-8
DN160 / 6" (65344 -)	13-15	9-11
DN200 / 8" (65346 -)	13-15	9-11
DN250 / 10" (65348 -)	17-20	13-15
	hole depth (mm)	hole depth (inch)
DN100 / 4" (65340 -)	12	0.47
DN160 / 6" (65344 -)	14	0.55
DN200 / 8" (65346 -)	15	0.59
DN250 / 10" (65348 -)	16	0.63



Refer to «Spare parts / Accessories» for centering rings ordering numbers.

4.2.6 Mounting with O-ring in grooves

Valve size	ISO-F	JIS	ASA-LP	ISO-F	JIS	ASA-LP
	max. tightening torque (Nm)			max. tightening torque (lbs . ft)		
DN100 / 4" (65340 -)	20-23	35-40	35-40	15-17	26-30	26-30
DN160 / 6" (65344 -)	35-40	35-40	35-40	26-30	26-30	26-30
DN200 / 8" (65346 -)	35-40	35-40	80-90	26-30	26-30	59-67
DN250 / 10" (65348 -)	35-41	65-70	80-90	26-30	48-52	59-67
	hole depth (mm)			hole depth (inch)		
DN100 / 4" (65340 -)	12	12	12	0.47	0.47	0.47
DN160 / 6" (65344 -)	14	14	14	0.55	0.55	0.55
DN200 / 8" (65346 -)	15	15	14	0.59	0.59	0.59
DN250 / 10" (65348 -)	16	16	16	0.63	0.63	0.63

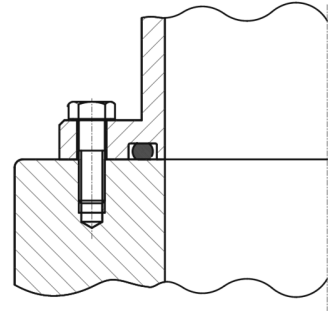

4.2.7 Admissible forces

	NOTICE
	<p>Force at valve body</p> <p>Forces from evacuating the system, from the weight of other components, and from baking can lead to deformation and malfunctioning of the valve.</p> <p>Do not higher force the valve body as specified.</p>

The following forces are admissible.

Valve size	Axial tensile or compressive force «F _A »		Bending moment «M»	
	N	lb.	Nm	lbf.
DN100 / 4" (65340 - -)	1000	220	40	30
DN160 / 6" (65344 - -)	2000	440	80	60
DN200 / 8" (65346 - -)	2000	440	80	60
DN250 / 10" (65348 - -)	2500	550	100	75
<p>For a combination of both forces (F_A and M) the values are invalid.</p> <p>Verify that the depth of the mounting screws is min. 1 x thread diameter.</p> <p>Please contact VAT for more information.</p>				

4.2.8 Requirements to sensor connection



To achieve fast and accurate pressure control a fast sensor response is required. Sensor response time: < 50ms. The sensor is normally connected to the chamber by a pipe. To maintain that the response time is not degraded by this connection it needs to meet the following requirements:

- Inner diameter of connection pipe: **> = 10 mm**
- Length of connection pipe: **< = 300 mm**

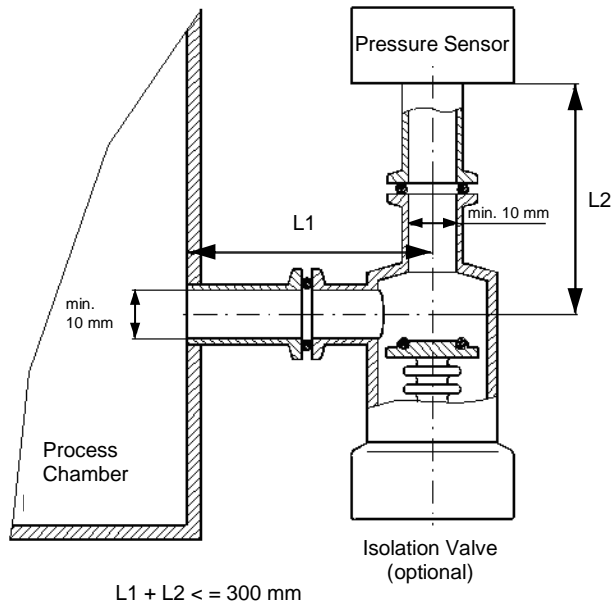
These conductance guidelines must include all valves and limiting orifices that may also be present. Make also sure that there is no obstruction in front of sensor connection port inside the chamber. The sensor should also be mounted free of mechanical shock and vibration. Dynamic stray magnetic fields may introduce noise to sensor output and should be avoided or shielded.



4.3 Electrical connection

	<p style="text-align: center;">NOTICE</p> <p>Wrong connection Wrong connection may result in damage of controller or power supply. Connect all cables exactly as shown in the following descriptions and schematics.</p>
	<p style="text-align: center;">NOTICE</p> <p>Burned connector pins (spark) Connector pins or electronic parts could damage, if plugged and unplugged under power. Do not plug or unplug connectors under power.</p>

4.3.1 Ground connection

Recommendation for ground strap between controller and system chassis.

Material	L (Length max.)	B1 (min.)	B2 (min.)	d1 (Ø)	d2 (Ø)
copper tinned	200 mm	25 mm	25 mm	4.5 mm	customized

Recommended torque: 1,3...1,7Nm

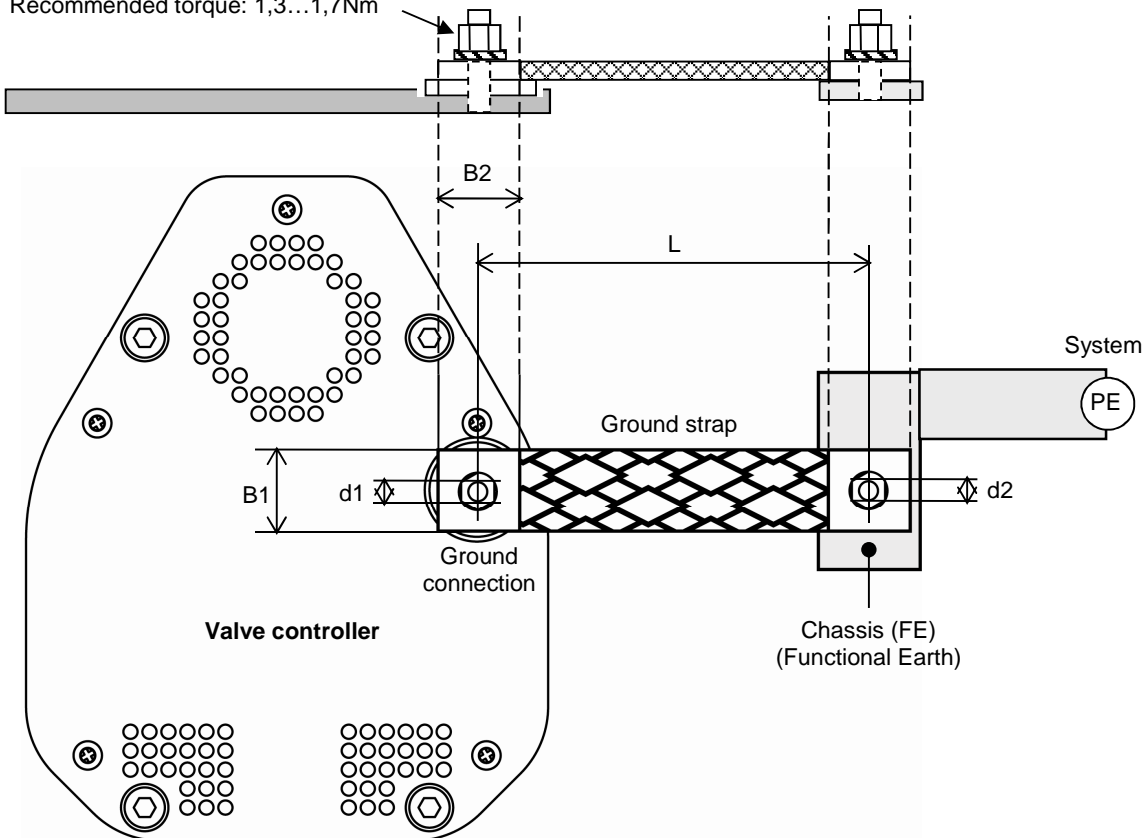

sample picture



Connection plates of ground strap must be total plane for a good electrical contact!

The connection point at chassis (FE) must be blank metal (not coated).
It is also possible to connect the ground strap at system chamber if it is well connected to PE.

Avoid low chassis cross section to the system PE connection. (min. same cross section as ground strap)

4.3.2 Power and Sensor supply concepts

This valve offers 3 alternative concepts to supply the sensor(s) with power. This depends on the sensor type and valve version that is used. This valve is available with an optional sensor power supply module (SPS) that converts ± 15 VDC from the 24 VDC.

Concepts:

- External +24 VDC supplied to POWER connector is feedthrough to SENSOR connector to supply 24 VDC sensors. Refer to chapter «Power and sensor connection (+24 VDC sensors)» for schematic and correct wiring.
- External ± 15 VDC supplied to POWER connector is feedthrough to SENSOR connector to supply ± 15 VDC sensors. Refer to chapter «Power and sensor connection (± 15 VDC sensors) without optional SPS module» for schematic and correct wiring.
- External +24 VDC supplied to POWER connector is converted into ± 15 VDC by the valve internal SPS and supplied to SENSOR connector to supply ± 15 VDC sensors. Refer to chapter «Power and sensor connection (± 15 VDC sensors) with optional SPS module» for schematic and correct wiring.



This concept is only possible when SPS retrofit is installed.

Valve versions:

- 653 **G** and 653 **H** SPS module not included
- 653 **A** and 653 **C** SPS module included



The SPS module can be retrofitted. Refer to chapter «Retrofit / replacement procedure» for instruction.

4.3.2.1 Power and sensor connection (+24 VDC sensors) via controller

[653 G / 653 H versions recommended]

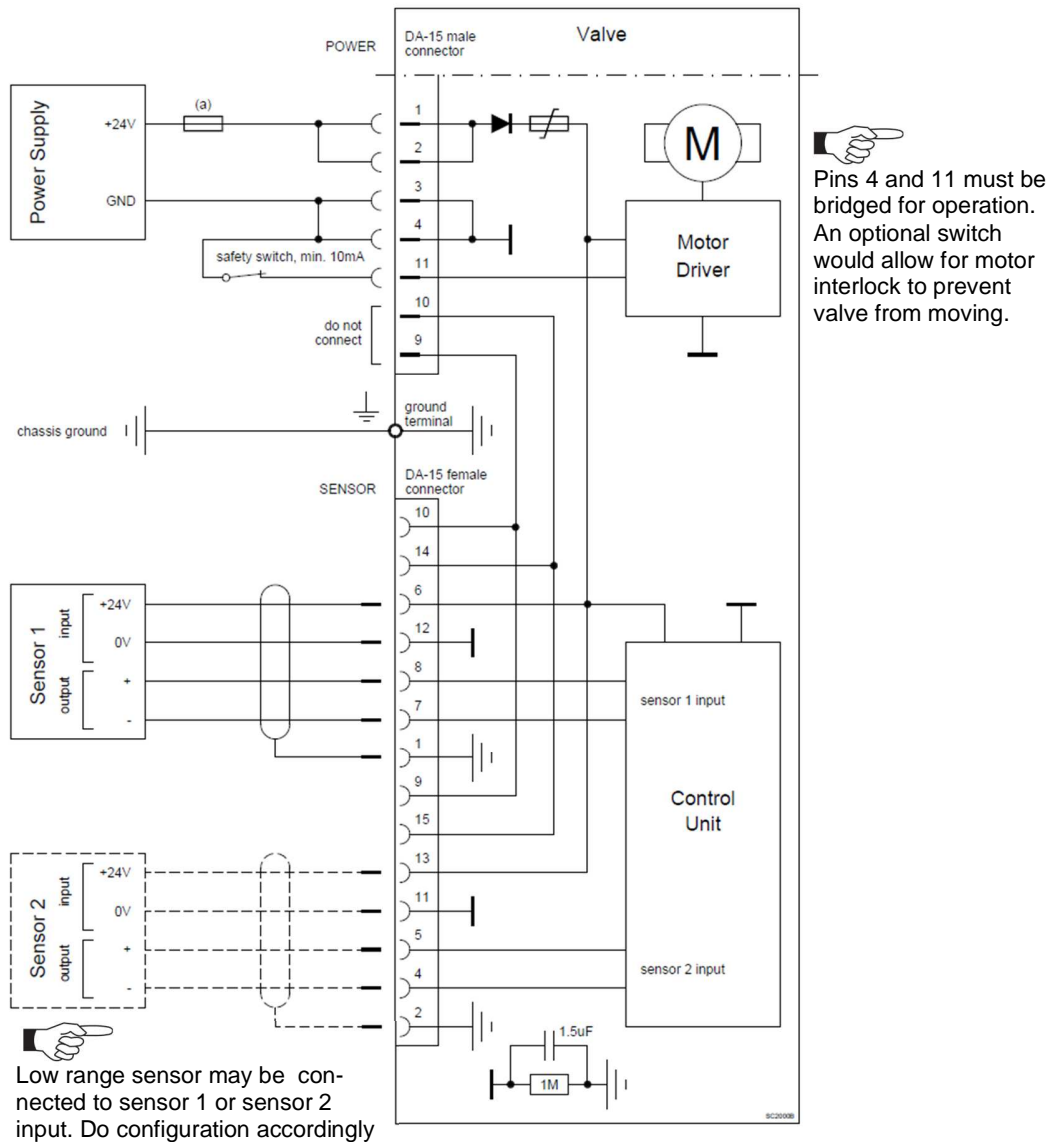

- **VAT fuse recommendation: (a) 7 AF**
- Use shielded sensor cable(s). Keep cable as short as possible, but locate it away from noise sources.
- Connect Power supply (+24 / GND) at DA-15 male power connector and Sensors (+24V / 0V / + / -) at DA-15 female sensor connector exactly as shown in the drawing above!
- Connector: Use only screws with 4-40 UNC thread for fastening the connectors!

4.3.2.2 Power and sensor connection (+24 VDC sensors) external

[653 G / 653 H versions recommended]

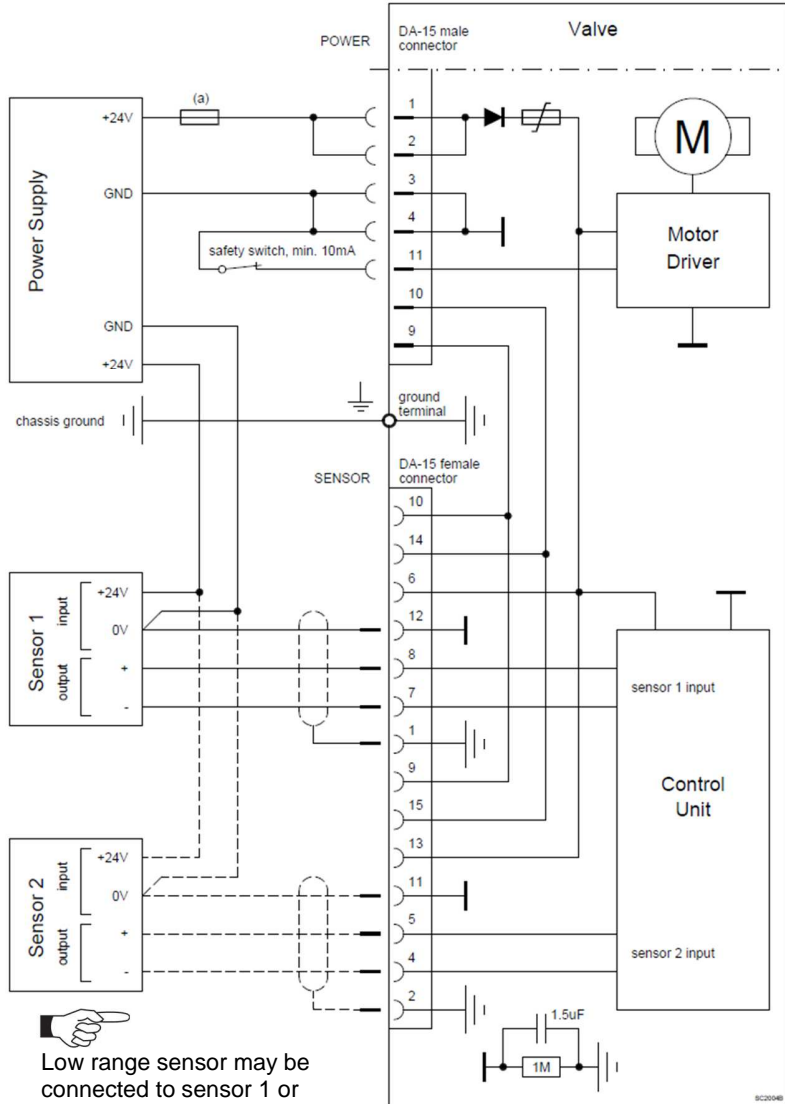

Pins 4 and 11 must be bridged for operation. An optional switch would allow for motor interlock to prevent valve from moving.

Low range sensor may be connected to sensor 1 or sensor 2 input. Do configuration accordingly.

- **VAT fuse recommendation: (a) 5 AF**
- Use shielded sensor cable(s). Keep cable as short as possible, but locate it away from noise sources.
- Connect Power supply (+24 / GND) at DA-15 male power connector and Sensors (0V / + / -) at DA-15 female sensor connector exactly as shown in the drawing above!
- Connector: Use only screws with 4-40 UNC thread for fastening the connectors!

4.3.2.3 Power and sensor connection (± 15 VDC sensors) without opt. SPS module via controller

[653 G / 653 H versions recommended]

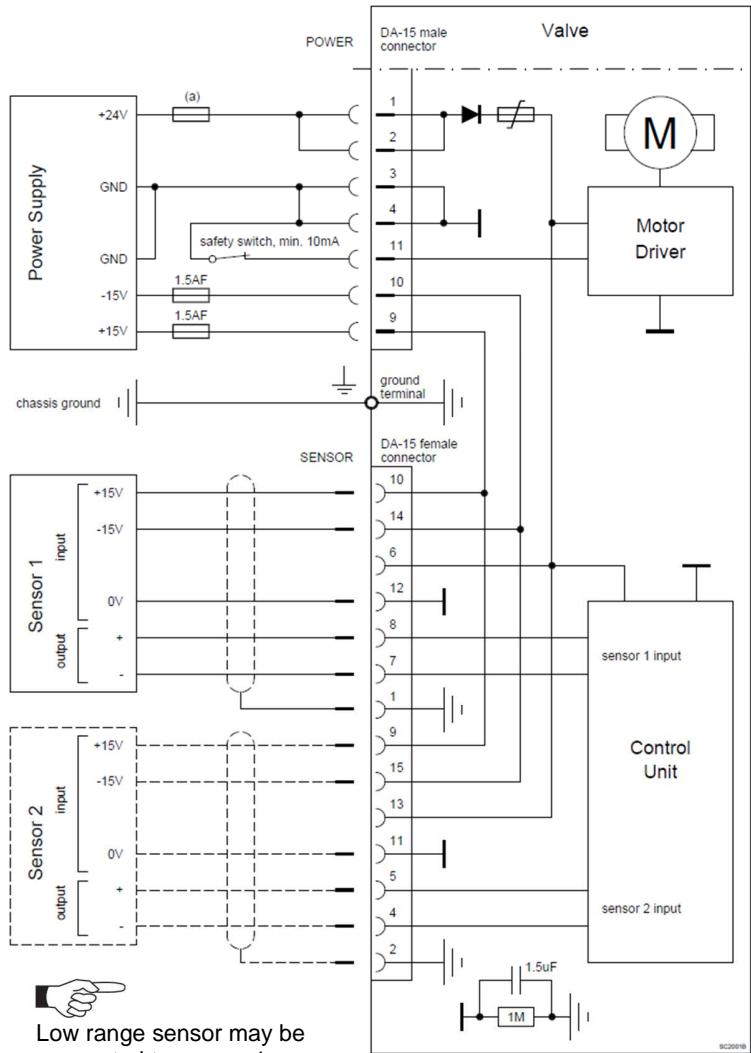

Pins 4 and 11 must be bridged for operation. An optional switch would allow for motor interlock to prevent valve from moving.

Low range sensor may be connected to sensor 1 or sensor 2 input. Do configuration accordingly.

- **VAT fuse recommendation: (a) 5 AF**
- Use shielded sensor cable(s). Keep cable as short as possible, but locate it away from noise sources.
- Connect Power supply (+24 / GND and GND / -15V / +15V) at DA-15 male power connector and Sensors (+15V / -15V / 0V / + / -) at DA-15 female sensor connector exactly as shown in the drawing above!
- Connector: Use only screws with 4-40 UNC thread for fastening the connectors!

4.3.2.4 Power and sensor connection (± 15 VDC sensors) without opt. SPS module external

[653 G / 653 H versions recommended]

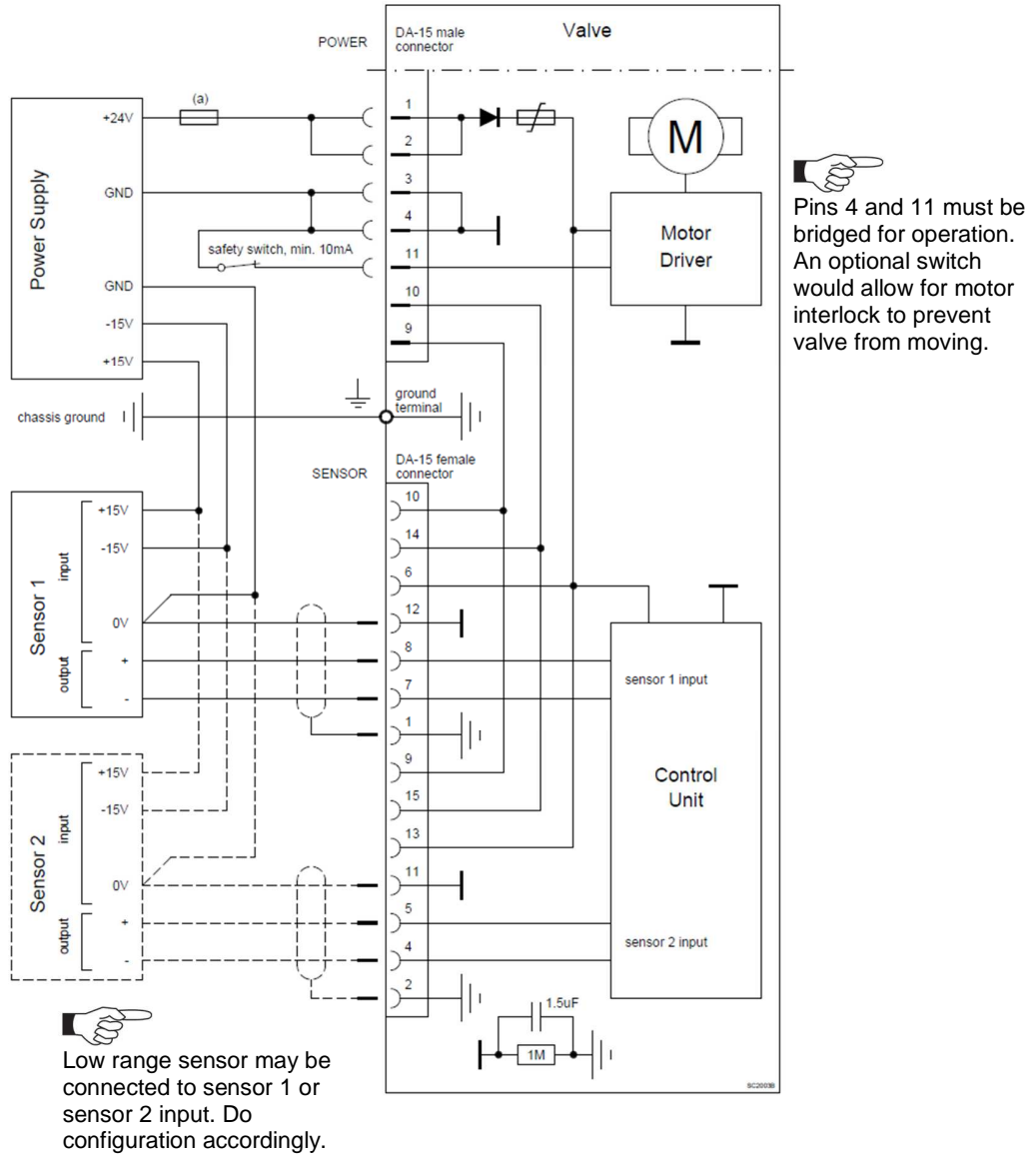

- **VAT fuse recommendation: (a) 5 AF**
- Use shielded sensor cable(s). Keep cable as short as possible, but locate it away from noise sources.
- Connect Power supply (+24 / GND) at DA-15 male power connector and Sensors (0V / + / -) at DA-15 female sensor connector exactly as shown in the drawing above!
- Connector: Use only screws with 4-40 UNC thread for fastening the connectors!

4.3.2.5 Power and sensor connection (± 15 VDC sensors) with optional SPS module

[653 A / 653 C versions only]

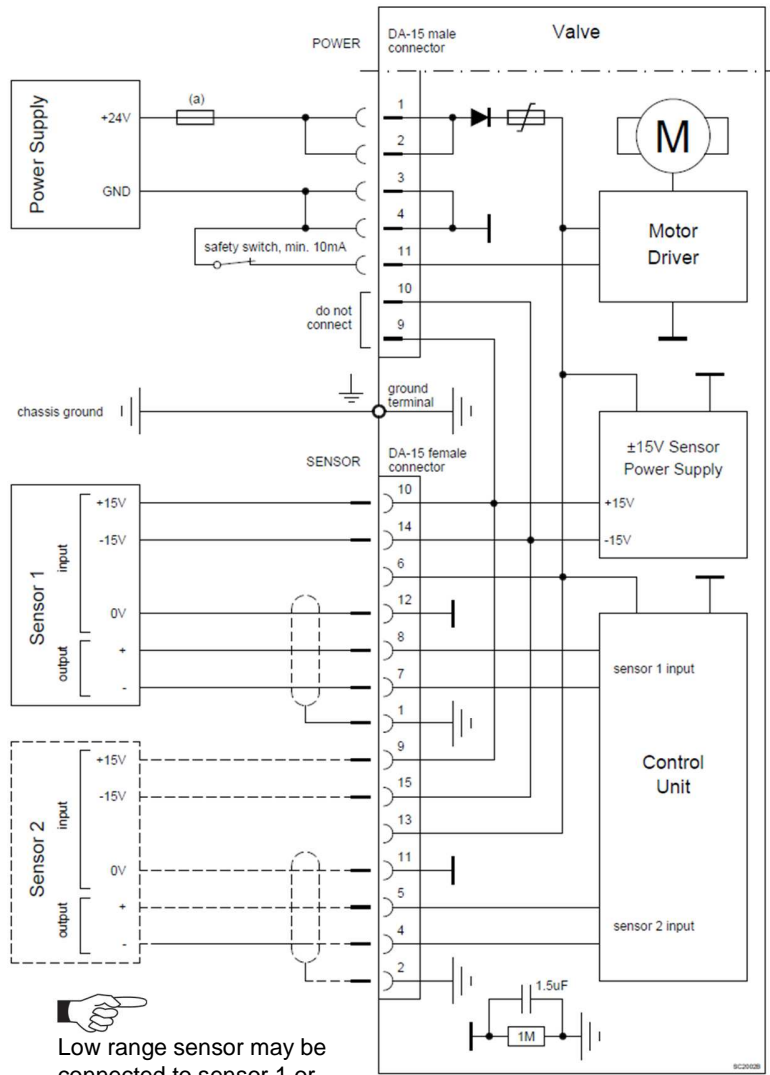

Pins 4 and 11 must be bridged for operation. An optional switch would allow for motor interlock to prevent valve from moving.

Low range sensor may be connected to sensor 1 or sensor 2 input. Do configuration accordingly.



- **VAT fuse recommendation: (a) 7 AF**
- Use shielded sensor cable(s). Keep cable as short as possible, but locate it away from noise sources.
- Connect Power supply (+24 / GND) at DA-15 male power connector and Sensors (+15V / -15V / 0V / + / -) at DA-15 female sensor connector exactly as shown in the drawing above!
- Connector: Use only screws with 4-40 UNC thread for fastening the connectors!

4.3.3 Digital Input/Output and analogue output connections

This interface allows for remote operation by means of a command set based on the RS232 protocol. In addition there are 2 digital inputs and 2 digital outputs. Digital inputs may be operated either by switches or by voltage sources.



Digital inputs on the **POWER** and **INTERFACE** connector have the **same priority**.



Active **digital inputs** have **higher priority than Logic** commands.



Do not connect other pins than indicated in the schematics above!
Use only screws with 4-40UNC thread for fastening the DA-15 / DB-25 connector!

4.3.4 Connection with switches over power supply connector



Switches from power supply connector have higher priority than switches from the interface connector

4.3.4.1 Configuration with switches for digital inputs

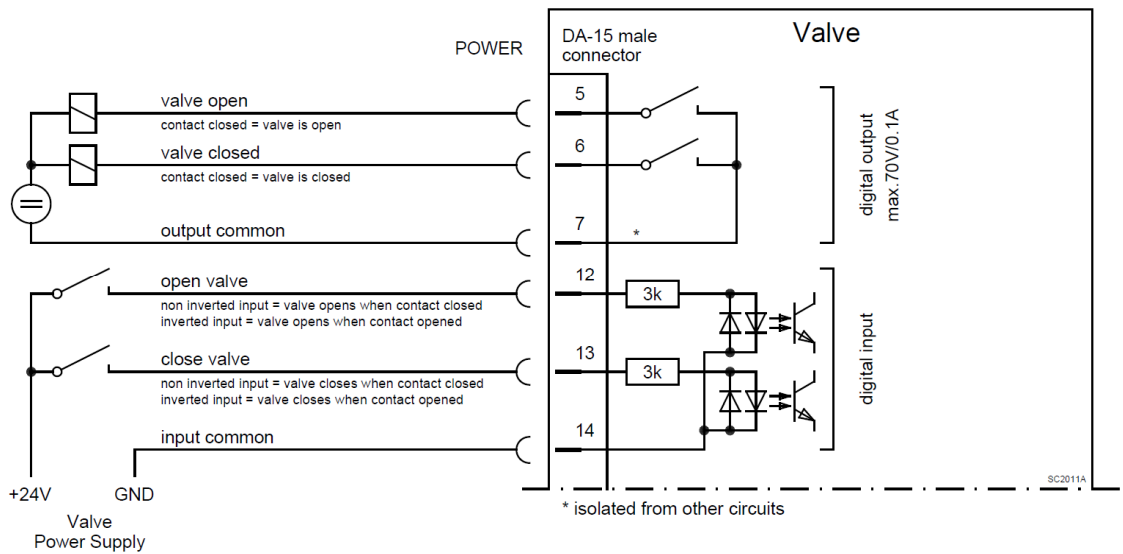

4.3.4.2 Configuration with voltage source for digital inputs

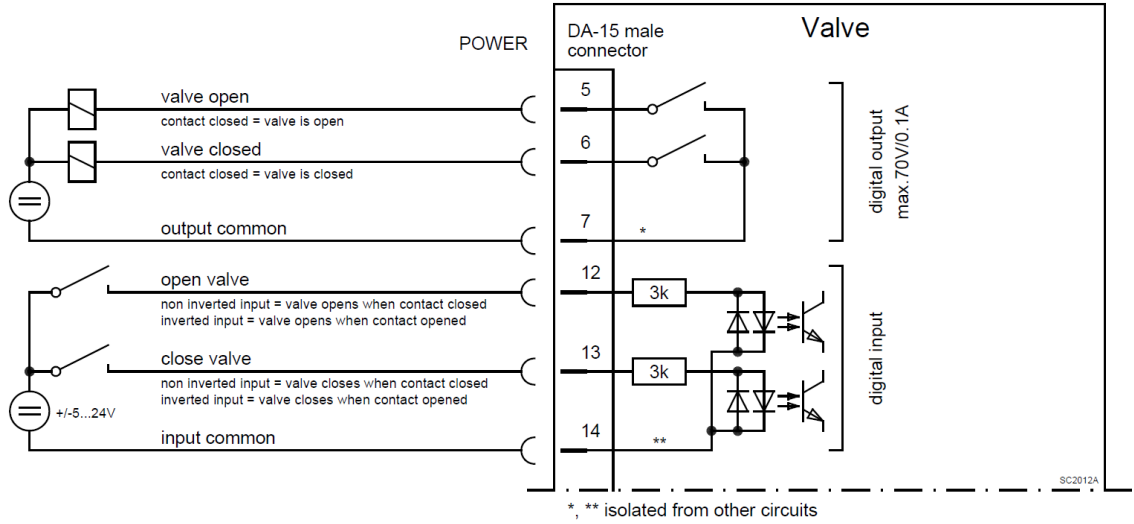

4.3.5 Service port connection

The service port (connector: SERVICE, USB - B) allows to connect the valve to a USB - A port of a computer. This requires a USB A-B cable male-male. The 'Service port is used for 'Local operation'.

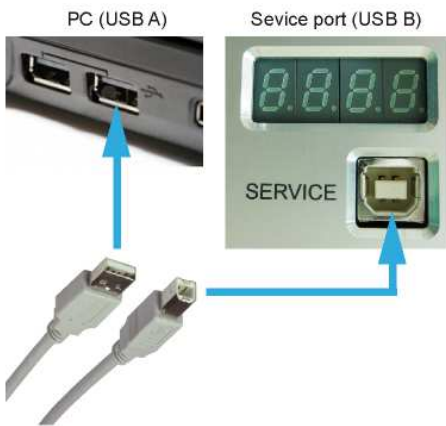

You can use our Software 'Control Performance Analyzer' 4.0 for Local operation, which is integrated in the IC2 and EC2 controller. Refer to chapter: 'Local operation' for detail information.

4.3.6 Functions and Wiring



Logic interface allows for remote operation by means of digital and analog signals. Digital inputs may be operated either by switches or by voltage sources.

a) Configuration with switches for digital inputs:

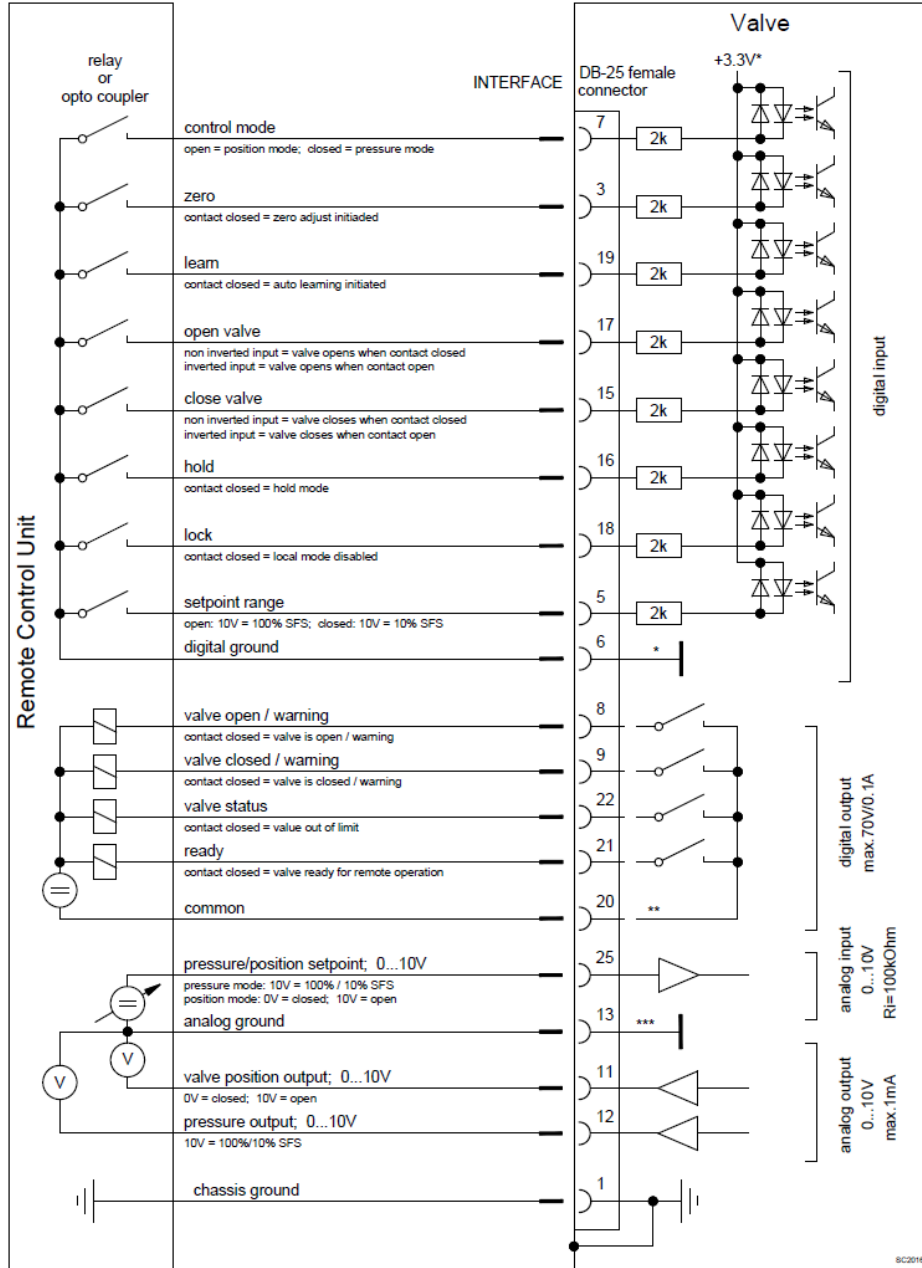

Do not connect other pins than indicated in the schematics above!
Use only screws with 4-40UNC thread for fastening the DB-25 connector!

b) Configuration with voltage source for digital inputs:

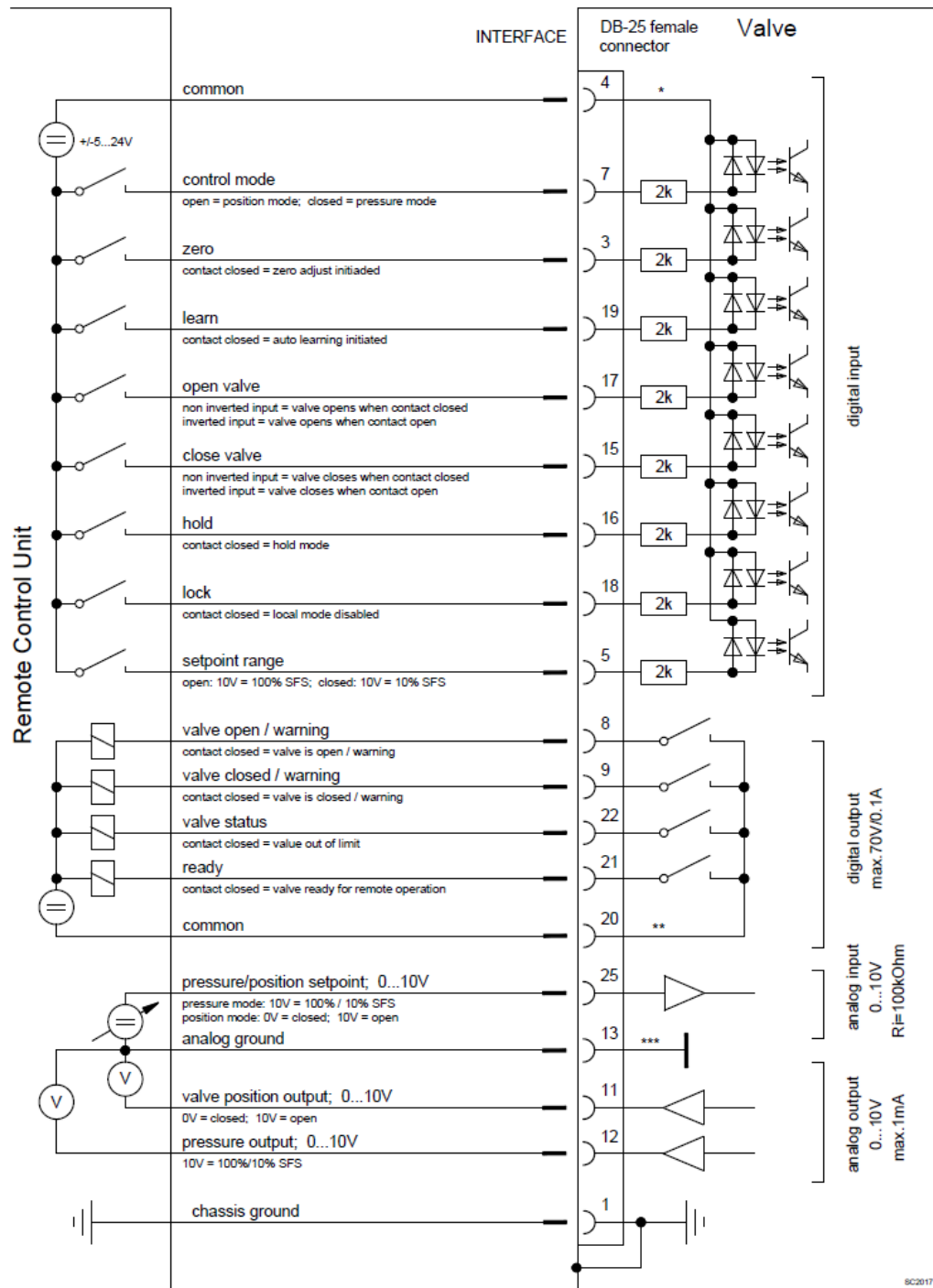

*, **, *** isolated from other circuits





Do not connect other pins than indicated in the schematics above!
Use only screws with 4-40UNC thread for fastening the DB-25 connector!

4.3.7 Digital inputs

Pin	Function	Signal type	Description	Priority
7	CONTROL MODE	Digital Input ¹⁾	<p>This pin selects the control mode. This valve may either be operated as pressure controller or as position controller.</p> <p><u>PRESSURE CONTROL</u> is activated as long as optocoupler is 'on'. The PID controller controls the chamber pressure according to the pressure SETPOINT by means of the valve position.</p> <p><u>POSITION CONTROL</u> is activated when optocoupler is 'off'. The valve position is directly controlled according to the position SETPOINT.</p>	6 ²⁾
5	SETPOINT RANGE	Digital input ¹⁾	<p>This pin selects the SETPOINT RANGE. Low range extension is activated as long as optocoupler is 'on'. It's effective in pressure control mode only.</p> <p>This function extends the lower 10% range of sensor full scale (SFS) to the full 0-10V for SETPOINT input. Herewith you can achieve better resolution, especially in case of a 2 sensor system.</p> <p>Example with SFS = 100mTorr: Not active (10V=100%) >> 10V setpoint = 100mTorr Active (10V=10%): >> 10V setpoint = 10mTorr</p>	N/A
16	HOLD	Digital input ¹⁾	<p>This function stops the valve at the current position. After release of the signal the valve will return to the selected CONTROL MODE. Only PRESSURE or POSITION Mode.</p> <p>This function is activated as long as optocoupler is 'on'.</p>	5 ²⁾
17	OPEN VALVE	Digital input ¹⁾	<p>This function will open the valve.</p> <p>This function is activated as long as optocoupler is 'on' in non inverted configuration. This function is activated as long as optocoupler is 'off' in inverted configuration.</p> <p>Configuration can be done in local operation via service port. Default settings is not inverted</p>	3 ²⁾
15	CLOSE VALVE	Digital input ¹⁾	<p>This function will close the valve.</p> <p>This function is activated as long as optocoupler is 'on' in non inverted configuration. This function is activated as long as optocoupler is 'off' in inverted configuration.</p> <p>Configuration can be done in local operation via service port. Default settings is not inverted</p>	2 ²⁾

1) All digital inputs are digitally filtered. Filter delay is 50ms. This means that digital signals must be applied for at least 50ms to be effective. Refer to «Function and wiring» for details about input circuit.

2) Highest priority is 1. Functions with lower priorities will not be effective as long as higher priority functions are active.

Pin	Function	Signal type	Description	Priority
3	ZERO	Digital Input ¹⁾	<p>This function compensates the pressure gauge offset voltage and sets the pressure value to zero. In case of a 2 sensor system both sensor inputs will be adjusted.</p> <p>This function is initiated by the 'off' to 'on' transition of the optocoupler.</p> <p>If 'on' remains established this will not re-initiate the function and does also not block functions with lower priorities.</p> <p> Do not perform ZERO as long as pressure gauge voltage is shifting.</p> <p>Do not perform ZERO, if the base pressure of your vacuum system is higher than 1‰ of sensor full scale. We recommend disabling ZERO function in this case. You can disable the function in local operation via service port.</p>	1 ²⁾
19	LEARN	Digital Input ¹⁾	<p>The LEARN routine determines the control characteristic of the vacuum system.</p> <p>This function is initiated by the 'off' to 'on' transition of the optocoupler. A transition from 'on' to 'off' while the routine is running would stop it.</p> <p>While running, the routine may not be interrupted by another function with higher priority. If 'on' remains established after completion this will not re-initiate the function and does also not block functions with lower priorities.</p> <p> Without a LEARN data set the PID controller is not able to perform pressure control.</p>	4 ²⁾
18	LOCK	Digital input ¹⁾	<p>This function locks the valve in remote operation. In case the valve is in local operation it will turn to remote operation. Local operation via service port is not possible when LOCK is activated.</p> <p>When the signal is released the valve remains in remote operation but local operation may be activated via service port.</p>	N/A
6	DIGITAL GROUND	Digital ground	<p>Ground for all digital inputs. Ground is used when digital inputs are operated by switches. Connect switches to ground. Refer also to «Function and wiring» configuration a).</p>	
4	DIGITAL COMMON	Digital common	<p>Common for all digital inputs. Common is used when digital inputs are driven by voltage sources. Connect + or – terminal of source with common (input optocouplers are capable of bidirectional operation). Refer also to «Function and wiring» configuration b).</p>	

- 1) All digital inputs are digitally filtered. Filter delay is 50ms. This means that digital signals must be applied for at least 50ms to be effective. Refer to «Function and wiring» for details about input circuit.
- 2) Highest priority is 1. Functions with lower priorities will not be effective as long as higher priority functions are active.

4.3.8 Digital outputs

Pin	Function	Signal type	Description
8	VALVE OPEN or SERVICE REQUEST	Digital output ¹⁾	<p>This output is active in all operation modes and indicates either that the valve is open or that a service is requested.</p> <p>A service request is indicated when the valve requires cleaning due to contamination.</p> <p>Configuration of the functionality of this output can be done in local operation via service port.</p> <p>By default the output indicates open</p>
9	VALVE CLOSED or SERVICE REQUEST	Digital output ¹⁾	<p>This output is active in all operation modes and indicates either that the valve is close or that a service is requested.</p> <p>A service request is indicated when the valve requires cleaning due to contamination.</p> <p>Configuration of the functionality of this output can be done in local operation via service port.</p> <p>By default the output indicates close</p>
22	VALVE STATUS	Digital output ¹⁾	<p>The meaning of this output depends on the operation mode. e.g.</p> <p><u>LEARN:</u> LEARN is not completed yet.</p> <p><u>PRESSURE CONTROL:</u> Actual pressure is out of $\pm 2\%$ range of SETPOINT</p> <p><u>POSTION CONTROL:</u> Actual position is out of $\pm 0.1\%$ range of SETPOINT</p>
21	READY	Digital output ¹⁾	<p>This signal indicates that the valve is ready for remote operation. If this signal is not active the valve is in one of the following modes:</p> <ul style="list-style-type: none"> • Synchronization during power up • Local operation via service port • Safety mode. Refer to «Safety mode» for details.
20	COMMON	Digital common	Common for all digital outputs.

1) Refer to «Function and wiring» for details about output circuit.

4.3.9 Analog inputs and outputs

Pin	Function	Signal type	Description
25	SETPOINT	Analog input ¹⁾	<p>The meaning of the setpoint input depends on the operation mode.</p> <p>LEARN: A voltage of 0-10V shall be applied to this input as pressure limit for learn. The limit pressure is in linear relation to the applied voltage. 10V relates to sensor full scale. In case of 2 sensor operation 10V relates to sensor 1 full scale (high range).</p> <p> To activate pressure limit function for remote operation it must be configured accordingly. Refer to «Interface configuration»</p> <p>PRESSURE CONTROL: A voltage of 0-10V shall be applied to this input as pressure setpoint. The pressure setpoint is in linear relation to the applied voltage. Depending on selected SETPOINT RANGE 10V means either sensor full scale or 10% of sensor full scale. In case of 2 sensor operation 10V relates to sensor 1 full scale (high range).</p> <p>POSITION CONTROL: A voltage of 0-10V shall be applied to this input as position setpoint. The position setpoint is in linear relation to the applied voltage. 0V is closed but not isolation function and 10V is open position. (Use digital input for isolation function)</p>
12	PRESSURE	Analog output ¹⁾	<p>This output indicates the current pressure as 0-10V. The output voltage is in linear relation to the pressure. Depending on the selected SETPOINT RANGE 10V means either sensor full scale or 10% of sensor full scale. In case of 2 sensor operation sensor full scale relates to sensor 1 (high range).</p>
11	POSITION	Analog output ¹⁾	<p>This output indicates the current valve position as 0-10V voltage range. The voltage is in linear relation to the valve position. 0V is closed but not isolation function and 10V is open position. (Use digital output for isolation function)</p>
13	ANALOG GROUND	Analog ground	Ground for analog input and analog outputs.
1	CHASSIS GROUND	Chassis ground	Chassis ground connected to case. Shall be used to connect cable shield.

1) Refer to «Function and wiring» for details about input / output circuit.

4.4 Initial operation



To enable the valve cluster for **pressure control** setup **steps 1 to 7 must be performed**. In case position control is required only it's sufficient to perform steps 1 to 4.

Setup step		Description
1	Power up	Turn on external + 24VDC power supply (and external ± 15 VDC for sensor power supply if required).
2	Scaling of Pressure and Position Values	Refer to chapter «Scaling of Pressure and Position Values» for details.
3	Valve configuration	Refer to chapter «Valve configuration» for details.
4	Interface configuration	Refer to chapter «Logic interface configuration» for details.
5	Sensor configuration	Basic configurations of the valve must be adapted according to application needs. Refer to chapter «Sensor configuration» for details.
6	Zero Adjust	Compensation of the sensor offset voltage. Refer to chapter «Sensor configuration» for details.
7a	Learn	<i>For adaptive pressure controller only.</i> Determination of the vacuum system characteristic to accommodate the PID controller. Refer to chapter «LEARN adaptive» for details.
7b	Pressure Control Configuration	Adaption of pressure controller to the vacuum system characteristic. Refer to chapter: «Pressure Control» for details.



Without «LEARN» or «PRESSURE CONTROL COFIGURATION» the valve is not able to run pressure control.

4.5 Scaling of Pressure and Position Values

The scaling for pressure and position values can be configured.

- The position scaler defines the unit/range of all position values: Target Position, Actual Position, ...
- The pressure scaler defines the unit/range of all pressure values: Target Pressure, Actual Pressure, ...

Overall there are individual scalers:

Service (CPA over USB) **Position Scaler**
 Pressure Scaler

Parameter location Service (CPA over USB) scaler

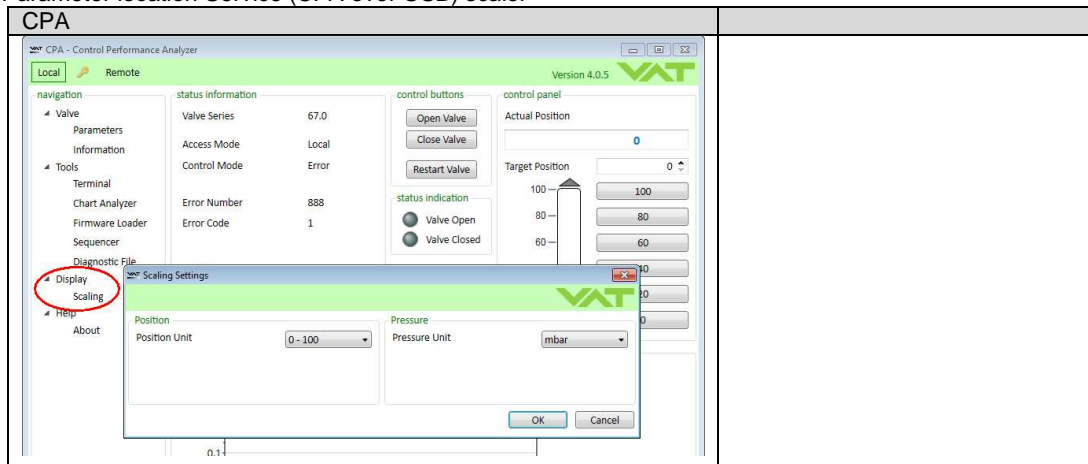

4.6 Configuration through CPA

4.6.1 Logic Interface configuration

Interface configuration must be adapted according to application needs.

Default configuration:

OPEN input	CLOSE input	OPEN output	CLOSE output
not inverted	not inverted	open	close

- Functionality of digital inputs CLOSE VALVE and OPEN VALVE must be selected. These may be configured as 'not inverted' or 'inverted'. Default is 'not inverted'.
- LEARN range configuration for remote operation must be selected. This may either be 'full range' or pressure limit according of analog SETPOINT input. Default is 'full range'.

Local operation: (‘Control Performance Analyzer’)	Remote operation:
<ul style="list-style-type: none"> • With CPA, do configuration in menu ‘Interface / Setup’. 	It's not possible to do ‘Interface configuration’ via remote operation.

4.6.1 Homing Start Option

Homing start option defines when the valve performs the homing procedure.

Parameter	Description												
Start Condition	<p>Homing start option defines when the valve performs the homing procedure.</p> <table> <tr> <td>Standard</td> <td>Do homing after restart if valve is not in sealed state</td> </tr> <tr> <td>Open Command</td> <td>Do homing on an open command</td> </tr> <tr> <td>Move Command</td> <td>Do homing on any move command</td> </tr> <tr> <td>At Startup</td> <td>Do homing after restart</td> </tr> <tr> <td>Homing Command</td> <td>Do homing on homing command</td> </tr> <tr> <td>Move Command/Standard</td> <td>Settings from move commands, without homing in close position by close command</td> </tr> </table>	Standard	Do homing after restart if valve is not in sealed state	Open Command	Do homing on an open command	Move Command	Do homing on any move command	At Startup	Do homing after restart	Homing Command	Do homing on homing command	Move Command/Standard	Settings from move commands, without homing in close position by close command
Standard	Do homing after restart if valve is not in sealed state												
Open Command	Do homing on an open command												
Move Command	Do homing on any move command												
At Startup	Do homing after restart												
Homing Command	Do homing on homing command												
Move Command/Standard	Settings from move commands, without homing in close position by close command												
End Control Mode	This control mode is set after a successful homing.												
End Position	In case the “End Control Mode” is set to “Position”, this parameter defines which position is set after successful homing.												

Parameter location:

CPA	
Valve->Homing	

4.6.2 Power Failure Option

These settings define what the valve is doing in case the power fails.

Parameter	Description
Enable	'True' enables the power fail reaction, in case of 'False' there is no reaction on a power fail
State	Current power fail state
Functionality	Defines the functionality in case of power fails. This can be "open" or "close".
Delay	After this delay the power failure reaction starts after the power failed

Parameter location:

CPA	
Power Fail Option	

4.6.3 Digital I/O

On the power connector there are two digital inputs and two digital outputs available. See chapter «Power and sensor connection» to get more information about the pinning.

Each of the four IO (2 inputs and 2 outputs) has following parameters:

Parameter	Description
Enable	'True' enables the input or output
State	Current state of the input or output
Functionality	Defines the functionality of the input or output
Inverted	'True' inverts the input or output. In case of an input, an inversion means that a '0' activate (State gets 1) the functionality and a '1' means not activated (State gets 0)

Parameter location:

CPA	
Power Connector IO	

4.7 Sensor configuration

4.7.1 Sensor configuration

It's important to do proper sensor configuration. The valve internally calculates in absolute values, so the valve has to know what sensors are connected.

Parameter	Description
Available	Set to 'True' if a sensor is connected
Enable	Set to 'True' if the sensor signal is used for pressure control
Range.Data Unit	Set the pressure data unit of the gauge
Range.Upper Limit Data Value Range.Lower Limit Data Value	Set the upper limit and lower limit of the gauge in the unit of "Range.Data Unit" Example for a 250mTorr linear sensor: Upper Limit = 250.0 Lower Limit = 0.0
Range.Upper Limit Voltage Value Range.Lower Limit Voltage Value	These parameters are only used for gauges with analog voltage interface. The values corresponds to Range.Upper Limit Data Value and Range Lower Limit Data Value Example: Upper Limit: 10.0V → 250mTorr Range Upper Limit Data Value Lower Limit: 0.0V → 0.0mTorr Range Lower Limit Data Value
Range.Scale	Select if a 'Linear' or a 'Logarithmic' type of gauge is used. Most gauges are linear type gauges.
Input Source	Select 'Analog' if a gauge with analog voltage interface is used. Select 'Digital' if an RS232 gauge is used.

"Sensor Crossover" defines the behavior when the actual pressure is around the upper limit of the low range sensor and define what sensor signal is used for building the Actual Pressure.

Parameter	Description
Crossover Mode	Execution method of the transient area from one sensor to the other: <ul style="list-style-type: none"> 0: Soft Switch Actual Pressure is a summation of the pressure value of sensor 1 and sensor 2. 1: Hard Switch Actual Pressure is the value of sensor 1 or sensor 2 2: Target Pressure During pressure control: If Target Pressure falls into low range sensor, the low sensor is used for Actual Pressure. In other case the high range sensor is used. During position control: 'Soft Switch' is used.

<p>Threshold High [SFS low sensor] Threshold Low [SFS low sensor]</p>	<p>Defines the crossover area in Crossover Mode 'Soft Switch' and 'Hard Switch'.</p> <p>Example: Threshold High = 1.0 [SFS of low sensor] Threshold Low = 0.9 [SFS of low sensor]</p> <p><u>Soft switch:</u> At pressure $\leq 0.9 \times \text{SFS low sensor}$: Actual Pressure = Sensor low pressure At pressure $0.95 \times \text{SFS low sensor}$: Actual Pressure = 50% * Sensor low pressure + 50% sensor high pressure At pressure $\geq 1.0 \times \text{SFS low sensor}$: Actual Pressure = Sensor high pressure</p> <p><u>Hard switch:</u> At pressure increase over $1.0 \times \text{SFS low sensor}$: Actual Pressure = Sensor high pressure after Delay At pressure decrease under $0.9 \times \text{SFS low sensor}$: Actual Pressure = Sensor low pressure after Delay</p>
<p>Delay</p>	<p>Switch over delay in Crossover Mode 'Hard Switch', see example above.</p>

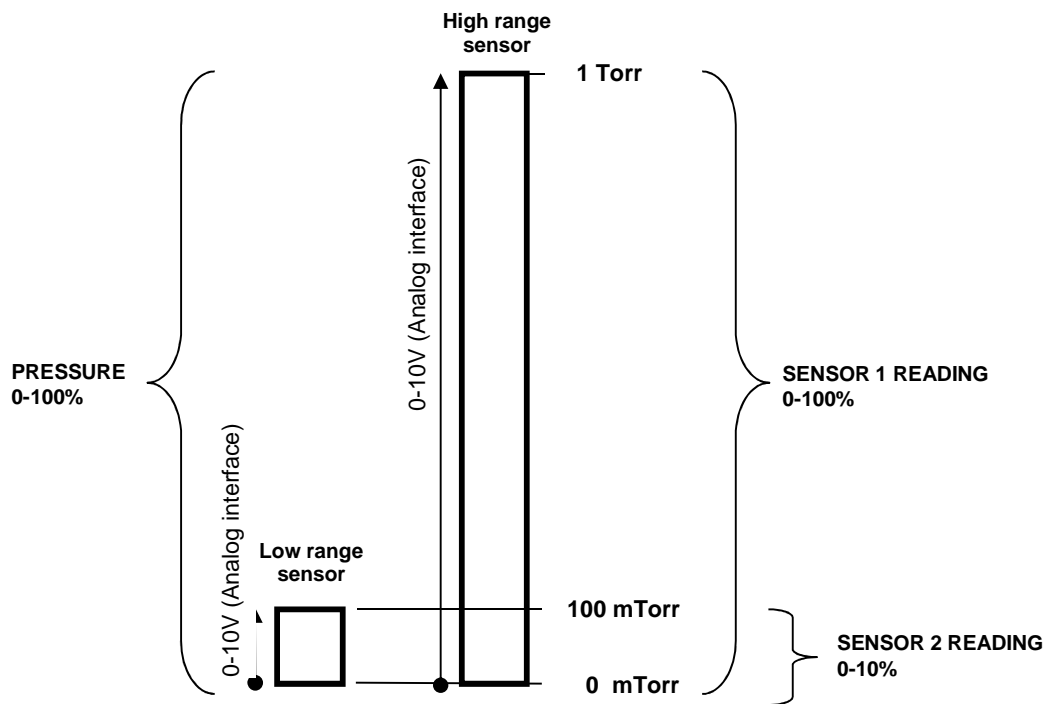

Analog sensors:

Sensor 1.Available = 1 Sensor 1.Enable = 1 Sensor 1.Range.Data Unit = Torr Sensor 1.Range.Upper Limit Data Value = 1.0 Sensor 1.Range.Lower Limit Data Value = 0.0 Sensor 1.Range.Upper Limit Voltage Value = 10.0 Sensor 1.Range.Lower Limit Voltage Value = 0.0 Sensor 1.Range.Scale = Linear Sensor 1.Input Source = Analog	Sensor 2.Available = 1 Sensor 2.Enable = 1 Sensor 2.Range.Data Unit = mTorr Sensor 2.Range.Upper Limit Data Value = 100.0 Sensor 2.Range.Lower Limit Data Value = 0.0 Sensor 2.Range.Upper Limit Voltage Value = 10.0 Sensor 2.Range.Lower Limit Voltage Value = 0.0 Sensor 2.Range.Scale = Linear Sensor 2.Input Source = Analog
---	--

4.7.2 Zero Adjust

Zero Adjust allows for the compensation of the sensor offset voltage.

When Zero Adjust is performed the current value at the sensor input is equated to Zero.Adjust Target Pressure.

In case of a 2 sensor system both sensor inputs will be adjusted.

Note: A maximum offset voltage of +/- 1.4 V can be compensated.

To execute a zero adjust, the zero adjust have to be enabled (see chapter above).

Parameter	Description
Zero Adjust.Sensor Selection	Select the sensor for the zero adjust: <ul style="list-style-type: none"> • Sensor 1 + 2 • Sensor 1 • Sensor 2
Zero Adjust.Target Pressure	Normally this parameter is set to 0 in case the process chamber is fully evacuated (which means pressure value is nearly 0). If not you can align the sensor value to a known pressure. In this case set Target Pressure to the current pressure. Note: Target Pressure is in the unit of pressure, see chapter «Scaling of Pressure and Position Values»
Zero Adjust.Execute	Start the zero adjust by set Execute to 1 At this moment offset value will be calculated and Sensor x.Value = Target Pressure. The resulting offset value can be read on parameter Sensor x.Offset Value [SFS] Clear the offset values by setting Execute to 2 The result of clearing the zero adjust: Sensor x.Offset Value [SFS] = 0.0
Sensor 1.Enable Sensor 2.Enable	0: It's not possible to execute a zero adjust. A present offset value is ignored. 1: It's possible to execute a zero adjust. A present offset value is respected.
Sensor 1.Offset Value [SFS] Sensor 2.Offset Value [SFS]	Value which will be subtracted from measured sensor value The value is related to sensor full scale (0.1 means 10% of sensor full scale)

Parameter location:

CPA	
Pressure Sensor->Zero Adjust	
Pressure Sensor->Sensor 1->Zero Adjust	
Pressure Sensor->Sensor 2->Zero Adjust	
Pressure Sensor->Sensor 1->Zero Adjust	
Pressure Sensor->Sensor 2->Zero Adjust	

Performing a zero adjust:

1. Wait until process chamber is evacuated and sensor signal is not shifting anymore. Do not perform Zero Adjust as long as pressure gauge voltage is shifting otherwise incorrect pressure reading is the result. Refer to manual of sensor manufacturer for warm up time.
2. Set parameter Sensor Selection
3. Set parameter Target Pressure (Zero Adjust->Target Pressure, not the Target Pressure for pressure control)
4. Set parameter Execute = 1
5. Check parameter Actual Pressure if the pressure is shifted as expected

For RS232 it's also possible to execute the zero adjust with the object «GENERAL CONTROL SETPOINT» of the PDO communication. In both case (perform the zero adjust **with Sensor Selection, Execute** and **Execute** or **GENERAL CONTROL SETPOINT**) the result is the same:

1. Wait until process chamber is evacuated and sensor signal is not shifting anymore. Do not perform Zero Adjust as long as pressure gauge voltage is shifting otherwise incorrect pressure reading is the result. Refer to manual of sensor manufacturer for warm up time.
2. In «OUTPUT Buffer» > «GENERAL CONTROL SETPOINT» set Bit 0 (rising edge).
3. Wait until Bit1 of «GENERAL STATUS» is set (see INPUT Buffer).



Do not perform Zero Adjust, if the base pressure of your vacuum system is higher than 1‰ of sensor full scale. We recommend disabling Zero Adjust function or using of Zero Adjust.Target Pressure other than 0.0 in this case. Otherwise incorrect pressure reading is the result.

4.8 Learn (adaptive control algorithm)

LEARN adapts the PID controller of the valve to the vacuum system and its operating conditions. LEARN must be executed only once during system setup. The LEARN routine determines the characteristic of the vacuum system. Based on this, the PID controller is able to run fast and accurate pressure control cycles. This characteristic depends on various parameters such as chamber volume, conductance and flow regime. Therefore it must be performed with a specific gas flow according to instruction below.

The result of LEARN is a pressure versus valve position data table. This table is used to adapt the PID parameters. The data table is stored in the device memory which is power fail save. The data table can be up-/downloaded via 'Control Performance Analyzer' software or remote interface. Due to encoding the data may not be interpreted directly.

By an OPEN VALVE, CLOSE VALVE, POSITION CONTROL or PRESSURE CONTROL command the routine will be interrupted.

Parameter	Description
Bank Selection	Select one of four learn bank to place the result of the learn procedure. Important: It's important that after the learn pressure controller select this learn bank!
Pressure Limit [SFS]	Set learn limit pressure (to which pressure the learn shall be executed). The value is related to the sensor full scale of high sensor. 1.0 means the whole pressure range of the sensors
Open Speed	Define the speed for opening the valve during the learn procedure. 1.0 means full speed
Status	State of the current learn 0: Not Started 1: In Progress 2: Completed Successfully 3: Aborted 4: Failed
Warning Info	Warning of current learn procedure: Bit 0: Learn is running Bit 1: Checksum error (learn data corrupt) Bit 2: Learn procedure terminated by user Bit 3: Pressure at position open > 50% of pressure limit Bit 4: Pressure at minimal conductance position < 10 % of pressure limit Bit 5: Pressure falls while move valve in direction of close Bit 6: Pressure at open position does not match pressure of previous open Bit 7: Learn procedure terminated by program Bit 8: Pressure <= 0 at open position (no gas flow set?)

Parameter location:

CPA	
Pressure Control->Adaptive Learn	

Execute a learn procedure:

1. Set specific gas flow according to calculation below and wait until flow is stable. Learn does not need to be performed with the process gas. Instead N₂ or Ar may be used.
2. Set parameter **Bank Selection**, if only one learn is used take Bank 1. Be sure that the pressure controller also selects this learn bank!
3. Set parameter **Open Speed**. If it's critical for the chamber, if the pressure falls rapidly while opening the valve, reduce the open speed.
4. Set parameter **Controller Mode = LEARN**.
5. Wait till **Controller Mode** leave to **LEARN** state → Learn procedure is finished
6. Check if the learn was successful by checking if **Status** shows value 2 (=Completed Successfully). In best case **Warning Info** shows no warning.



Sensor signal must not shift during LEARN. Wait until sensor signal is stable before LEARN is performed. Learn may take several minutes. Do not interrupt the routine as a single full run is required to ensure fast and accurate pressure control. The PID controller covers 5% to 5000% of the gas flow which was used for learn.

Gasflow calculation for LEARN:



Do not apply a different gasflow for learn than determined below. Otherwise pressure control performance may be insufficient.

Required pressure / flow regime must be known to calculate the most suitable learn gas flow for a specific application.

- At first it is necessary to find out about the required control range respectively its conductance values. Each working point (pressure / flow) must be calculated with one following formulas. Choose the applicable formula depending on units you are familiar with.

$$C_{WP} = \frac{1000 \cdot q_{WP}}{p_{WP}}$$

C_{WP} required conductance of working point [l/s]
 q_{WP} **gasflow** of working point [**Pa m³/s**]
 p_{WP} **pressure** of working point [**Pa**]

$$C_{WP} = \frac{q_{WP}}{p_{WP}}$$

C_{WP} required conductance of working point [l/s]
 q_{WP} **gasflow** of working point [**mbar l/s**]
 p_{WP} **pressure** of working point [**mbar**]

$$C_{WP} = \frac{q_{WP}}{78.7 \cdot p_{WP}}$$

C_{WP} required conductance of working point [l/s]
 q_{WP} **gasflow** of working point [**sccm**]
 p_{WP} **pressure** of working point [**Torr**]

- Out of these calculated conductance values choose the lowest.

$$C_R = \min(C_{WP1}, C_{WP2}, \dots, C_{WPn})$$

C_R required lower conductance [l/s]
 C_{WPx} required conductance of working points [l/s]



To make sure that the valve is capable to control the most extreme working point verify that $C_R \geq C_{\min}$ of the valve (refer to «Technical data»).

- Calculate gasflow for learn. Choose the applicable formula depending on units you are familiar with.

$$q_L = \frac{p_{SFS} \cdot C_{\min}}{1100}$$

q_L gasflow for learn [**Pa m³/s**]
 p_{SFS} sensor full scale pressure [**Pa**]
 C_{\min} min. controllable conductance of valve [l/s], (refer to «Technical data»)

$$q_L = \frac{p_{SFS} \cdot C_{\min}}{1.1}$$

q_L gasflow for learn [**mbar l/s**]
 p_{SFS} sensor full scale pressure [**mbar**]
 C_{\min} min. controllable conductance of valve [l/s], (refer to «Technical data»)

$$q_L = 71 \cdot p_{SFS} \cdot C_{\min}$$

q_L gasflow for learn [**sccm**]
 p_{SFS} sensor full scale pressure [**Torr**]
 C_{\min} min. controllable conductance of valve [l/s], (refer to «Technical data»)

4.9 Pressure Control

The valve has four identical pressure controller units. **Controller Selector** defines which unit is used for the pressure control.

Most applications do not need more than one controller units. But if the result of the pressure control does not meet the expectations, the different controller units can be an option for optimization: With the four controller units it's possible to use an own controller unit for a specific pressure working point. This controller unit can be parametrized optimally for this specific working point.

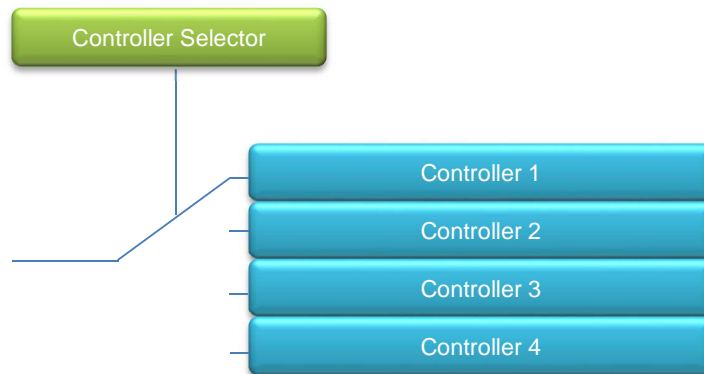

Figure 1: The Controller Selector selects the controller.

4.9.1 Pressure control operation with 2 sensors

If 2 sensor operation is enabled, changeover between the sensors is done automatically during pressure control. For configuration refer to chapter «Setup procedure». We recommend a ratio of 10:1 between the pressure gauges. Max. ratio is 100:1. High range respectively low range pressure gauge may be either connected to sensor 1 or sensor 2 input. It's required to do correct sensor configuration.

Between 90 and 100% of the low range sensor full scale, the low range sensor is phased out while high range sensor is phased in during pressure rise. During pressure decrease the high range sensor is phased out while low range sensor is phased in. This maintains a functional response behavior in case of small calibration errors between the two sensors. The PRESSURE output in this range is a blend between both sensors.

For monitoring purpose each sensor signal may be read out individually. Refer to «inquiry commands SENSOR 1 READING and SENSOR 2 READING»



Make sure that both sensors are calibrated. Do not close optional gauge isolation valves during the transition phase between the sensors.

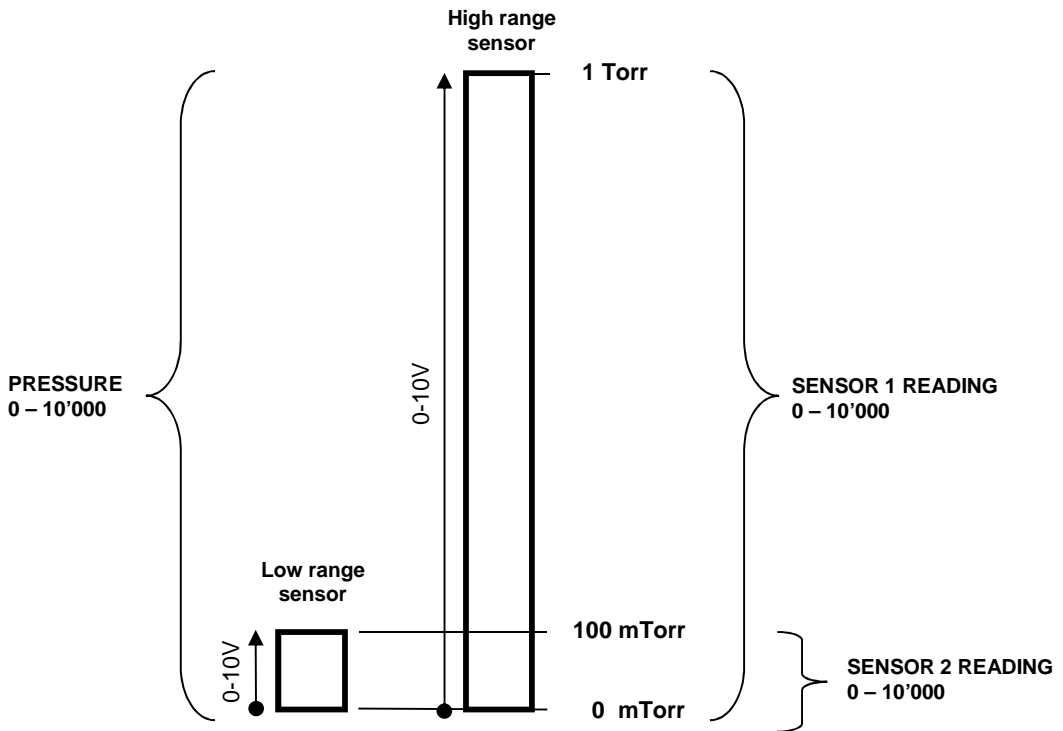

4.9.2 Control parameters

This chapter describes the functionality of Controller 1 to Controller 4.

4.9.2.1 Control algorithm

Parameter location:

CPA	
Pressure Control	
Pressure Control->Pressure Controller 1	
Pressure Control->Pressure Controller 2	
Pressure Control->Pressure Controller 3	
Pressure Control->Pressure Controller 4	

The main parameter of a controller unit is its **Control Algorithm**. There are different control algorithms implemented in the firmware of the valve. The user can select the control algorithm which fits his demands.

Control Algorithm	Description
<i>Adaptive</i>	This is the most dynamic control algorithm. Before using adaptive control algorithm, a special procedure called "learn" must be executed first (see chapter x). The valve will observe the behavior of the vacuum system by moving the valve to different positions. During the learn procedure the valve performs an internal parameter estimation correspondent to the vacuum system. Note: The adaptive pressure control work at its best if the conditions (mainly gas flow) are close the conditions at the learn procedure.
<i>PI</i>	This is a solid algorithm for pressure control. The performance will be behind the adaptive control algorithm. But if the condition varies a lot, it's possible that the adaptive control algorithm does not work properly so the PI algorithm provides the best result.
<i>Soft Pump</i>	Is a modified PI control algorithm to pump down from atmospheric pressure. This control algorithm has been optimized to prevent that the pressure in the chamber is falling too fast (reduce occurrence of undershoots).

4.9.2.2 Control parameter

Depending on the Control Algorithm setting there are different parameters available to adjust the algorithm:

	Parameter	Description
Adaptive	Gain Factor	<i>The Gain Factor is a control parameter to adapt the performance of the pressure control algorithm. A higher gain results in a faster response, higher over- / undershoots of pressure. A lower gain results in slower response, lower over- / undershoot of pressure.</i>
	Sensor Delay	<i>The Sensor Delay is a control parameter to compensate delays during the pressure detection. Pipes and orifices for sensor attachment can cause delays in response time and could impact badly the pressure control stability. By adapting this parameter to the approximate delay time stability problems can be reduced. But control response time will be slowed down by this measure.</i>
	Learn Data Selection	<i>There are up to 4 different learn data sets available. Select which Learn Data set the adaptive controller shall use for pressure control.</i>
PI	P-Gain	<i>The P-Gain is the proportional factor of the fixed control algorithm. A higher P-Gain results in faster response, higher over- / undershoot of pressure.</i>
	I-Gain	<i>The I-Gain is the integral factor. The I-Gain helps to reach the target pressure exactly.</i>
	Direction	<i>The Control Direction defines the type of application, if the valve is mounted in downstream or upstream. Downstream means the valve is after the chamber and before the pump. Upstream, valve is mounted before chamber and pump.</i>
Soft Pump	P-Gain	<i>The P-Gain is the proportional factor of the fixed control algorithm. A higher P-Gain results in faster response, higher over- / undershoots of pressure.</i>
	I-Gain	<i>The I-Gain is the integral factor. The I-Gain helps to reach the target pressure exactly.</i>

4.9.2.3 Pressure ramp

Basically, the pressure ramp is used to limit the rate of pressure change. It can also be used to minimize over- / undershoot of pressure.

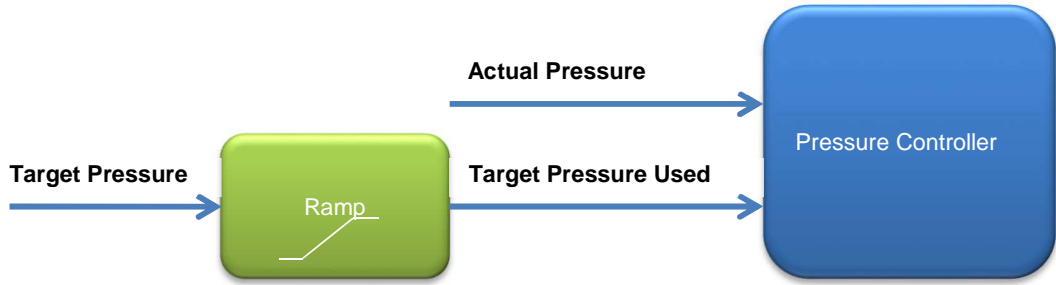

New Target Pressure without pressure ramp

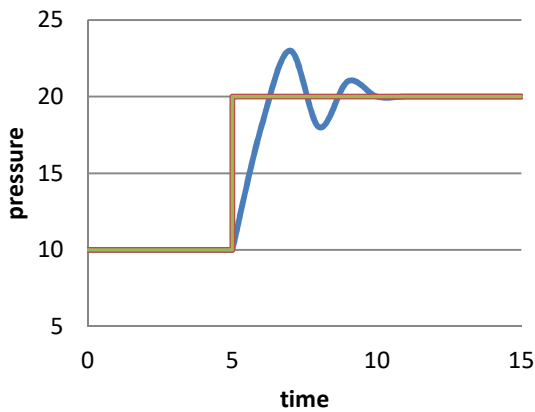

- Actual Pressure
- Target Pressure
- Target Pressure Used (ramp)

New Target Pressure with pressure ramp

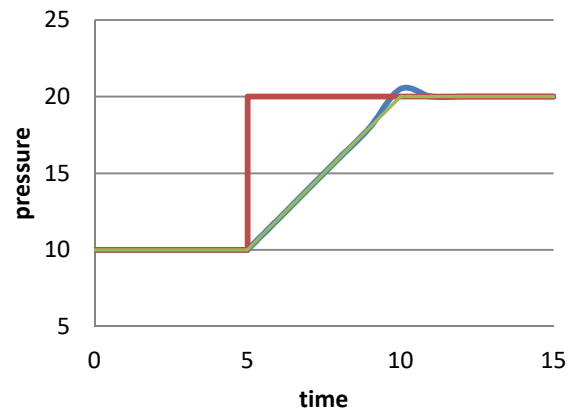

- Actual Pressure
- Target Pressure
- Target Pressure Used (ramp)



4.9.2.4 Pressure ramp configuration

Time Mode (Ramp Mode = Time)

The time within **Target Pressure Used** (ramp) reaches a new **Target Pressure** is defined in parameter value **Ramp Time**. **Ramp Time** is a value in the unit [seconds].

Slope Mode (Ramp Mode = Slope)

After setting a new **Target Pressure**, **Target Pressure Used** will converge the **Target Pressure** in the slope defines in parameter **Ramp Slope**. **Ramp Slope** is a value in the unit [pressure / seconds]

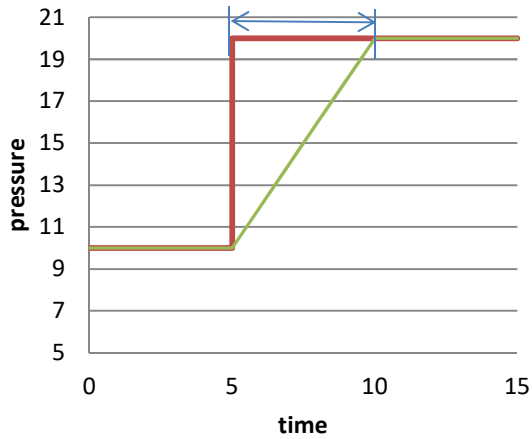

— Target Pressure
— Target Pressure Used (ramp)

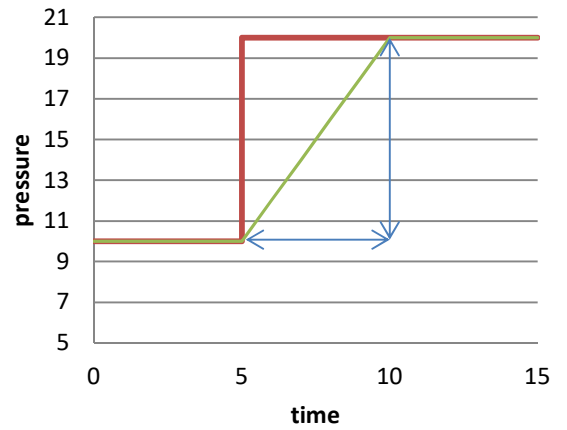

— Target Pressure
— Target Pressure Used (ramp)

4.9.3 Choose correct control algorithm

Select the configuration what your application needs.

System Configuration	Constant gas flow available		Constant gas flow not available
	Tv* <= 500 sec	Tv* > 500 sec	
<p>Downstream</p>	<p>Adaptive pressure controller</p>	<p>Fixed pressure controller</p>	
<p>Upstream</p>	<p>Fixed pressure controller</p>		
<p>Soft Pump</p>	<p>Soft Pump</p>		



Use the formula below to define the applicable pressure control algorithm.

$$T_v = \frac{P_{SFS} \cdot CV}{q_L}$$

- q_L** gasflow for learn [mbar/s]
- p_{SFS}** sensor full scale pressure [mbar]
- T_v*** Vacuum time constant [sec]
- CV** Chamber Volume [l]

4.9.4 Tuning of control performance

- Tuning of pressure control performance with adaptive control, refer to chapter: Tuning of control performance with adaptive pressure controller
- Tuning of pressure control performance with PI control, refer to chapter: Tuning of control performance with fixed PI pressure controller
- Tuning of control pressure performance with Soft pump , refer to chapter: Tuning of control performance with soft pump pressure controller

4.9.4.1 Tuning of control performance with adaptive pressure controller

Normally the default settings will result in good pressure control performance. For some applications tuning may be required to improve performance. The tuning procedures for each parameter (grey boxes) and its default values are described separately below. Strictly keep the procedure order.

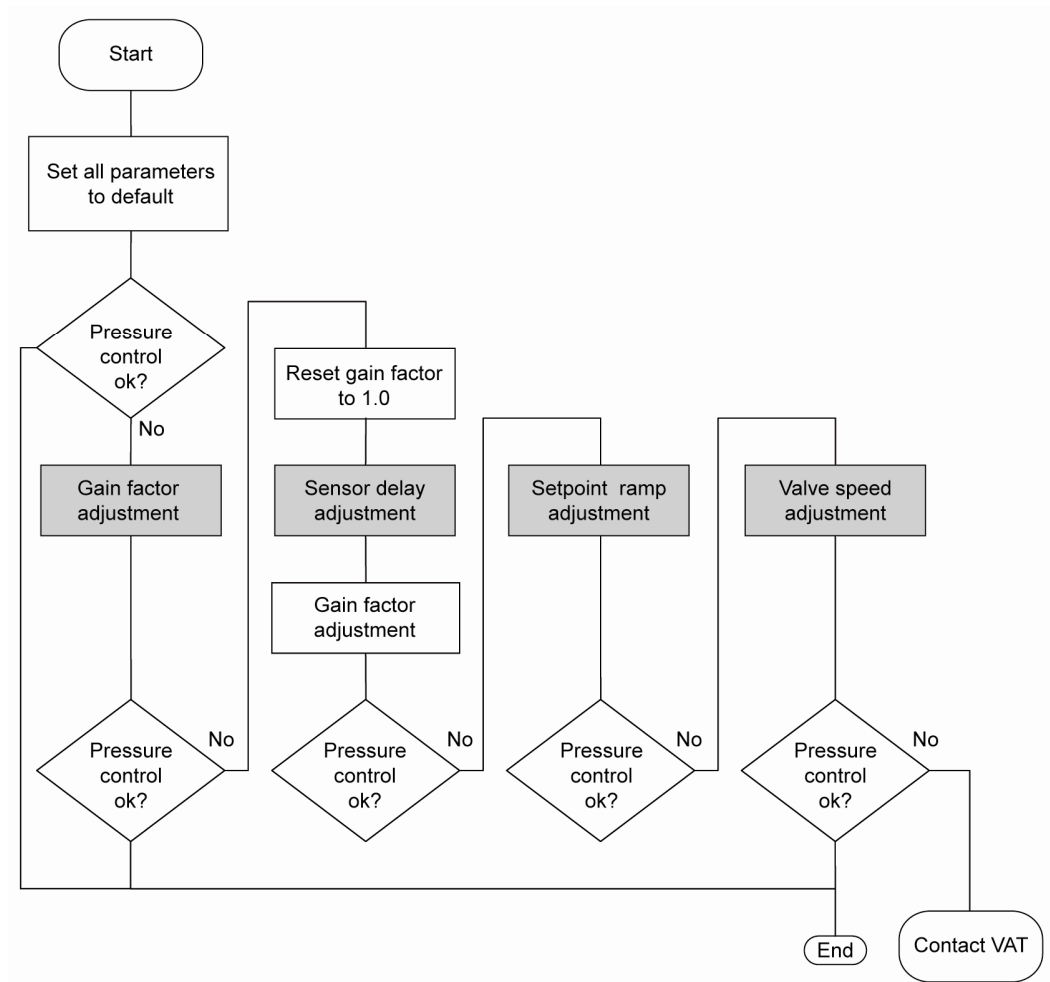

Gain factor adjustment

The gain factor effects: **Stability, Response time**

Adjustment range is from 0.0001 to 7.5.

- Higher gain results in: faster response / higher over- / undershoot of pressure
- Lower gain results in: slower response/ lower over- / undershoot of pressure

Adjustment procedure:

1. Start with gain factor 1.0
2. Open valve.
3. Control a typical pressure / flow situation.
4. Repeat from step 2 with lower (higher) gain factors until optimal pressure response is achieved and stability is ok.



Normally adjustments down to gain factors of 0.42 should lead to good results. Otherwise you may need to improve sensor connection. Refer to «Requirements to sensor connection».

Sensor delay adjustment

Sensor delay adjustment effects: **Stability**

Adjustment range is from 0 to 1.0s.

Pipes and orifices for sensor attachment delay response time and so badly impact pressure control stability.

By adapting this parameter to the approximate delay time stability problems can be reduced. But control response time will be slowed down by this measure.



Whenever possible sensors should be attached to the chamber according to «Requirements to sensor connection». This is the most effective measure against stability issues. If your gauge attachment fulfills these criteria do not use this parameter.

Adjustment procedure:

1. Start with gain factor 1.0 and sensor delay 0s.
2. Open valve.
3. Control a typical pressure / flow situation.
4. Repeat from step 2 with higher sensor delays until best possible stability is achieved.
5. Adjustment gain factor again. Refer to «Gain factor adjustment».

Setpoint ramp adjustment

Setpoint ramp effects: **Undershoot of pressure, Response time**

Adjustment range for Setpoint Ramp is from 0 to 10 s.

This parameter defines the time that is used to decrease / raise pressure between 2 setpoints. Especially in pressure decrease situations at low flows pressure response can be improved much by adapting setpoint ramp time.

Pressure chart

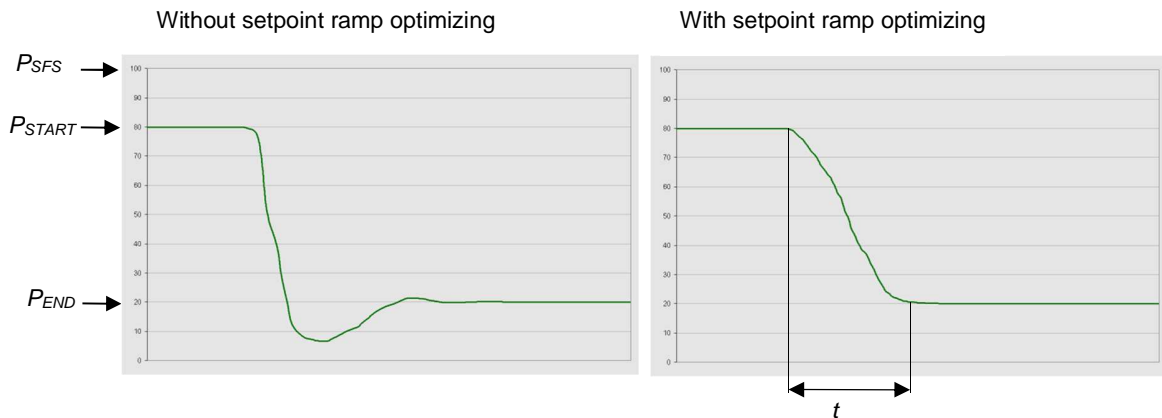

Choose the applicable formula depending on units you are familiar with.

$$t = \text{Setpoint Ramp}$$

Adjustment procedure:

1. Start with optimal gain factor and sensor delay time according to preceding tuning steps.
2. Control a typical pressure / flow situation.
3. Control a lower pressure.
4. Repeat from step 2 with longer setpoint ramps until best response is achieved.
5. Verify pressure control response for a setpoint raise situation.



In case a long ramp time is required to get optimal performance for pressure decrease situations it may be of advantage to apply different settings for decrease / raise control situations.

Valve speed adjustment

Valve speed effects: **Response time**

Default value is 1.0. Adjustment range is from 0.01 to 1.0.

This parameter effects valve plate actuating speed.
Speed adjustment is effective for PRESSURE CONTROL and POSITION CONTROL.



Normally best pressure control response is achieved with max. valve speed. In particular applications it may be of advantage to have a slower valve response. OPEN and CLOSE are always done with maximum speed.

Adjustment procedure:

1. Use optimal gain factor, sensor delay time and setpoint ramp according to preceding tuning steps.
2. Open valve.
3. Control a typical pressure / flow situation.
4. Repeat from step 2 with slower valve speed until required response is achieved.

Required information for support:

- Go to 'Tools / Create Diagnostic File' in 'Control Performance Analyzer' and save file
- Pressure / flow / gas conditions to be controlled
- Chamber volume
- Pumping speed (l/s) and pump type (e.g. turbo pump)
- System description
- Problem description

Send diagnostic file with and all required information to tuning-support@vat.ch

4.9.4.2 Tuning of control performance with fixed PI pressure controller

Optimizing P gain and I gain

This valve may be used for downstream or upstream pressure control depending on configuration. The PI parameters of the pressure controller require correct adjustment. These parameters must be set once during system setup and are stored in the device memory which is power fail save. Based on the PI controller configuration, the valve is able to run fast and accurate pressure control cycles. The PI parameters can be evaluated using below instruction.



- In downstream control mode valve will move towards open when current pressure is higher than set point.
- In upstream control mode valve will move towards close when current pressure is higher than set point.

Introduction

PI controller mode is used if for any reason (e.g. too long system time constant) the adaptive control mode does not provide satisfying control performance.

In PI controller mode the parameters P gain and I gain have to be set according to the systems characteristics. The best set of parameters can be found by using the empiric method below.

1. Optimizing P gain and I gain

1.1 Pressure and gas flow for optimization

A PI controller delivers the best results for a certain working point (pressure/gas flow). If there is only one working point, this pressure and gas flow has to be used for optimizing P and I gain. If there are several working points that have to be covered, the pressure for optimizing is the medium pressure between highest and lowest pressure to be controlled, the gas flow for optimizing is the highest flow out of all working points.

Two different pressure set points are necessary for optimization. Set point 1 (SP1) is the pressure for optimizing as determined above. Set point 2 (SP2) is about 10 - 20% lower than SP1.

Example: pressure range: 4 – 10 Torr
Flow range: 2 – 4 slm

Pressure set points and gas flow for optimization:

SP1	=	7 Torr
SP2	=	6 Torr
Gas flow	=	4 slm

1.2 Optimizing P gain

While optimizing P gain, the gas flow determined above has to be constant all the time.

Start optimization with P gain set to 1.0 and I gain set to 0.0.

Set chamber pressure to SP2, wait until the pressure is stable. Set pressure to SP1. If the transition from SP2 to SP1 results in a significant pressure over shoot or even does not stabilize at all, the P gain is too high. If there is no over shoot and the pressure reaches SP1 asymptotically and very slow, P gain is too low.

The optimal P gain value is found if the transition from SP2 to SP1 results in a slight pressure over shoot. It does not matter if there is still a deviation between SP1 and actual pressure.

Example:

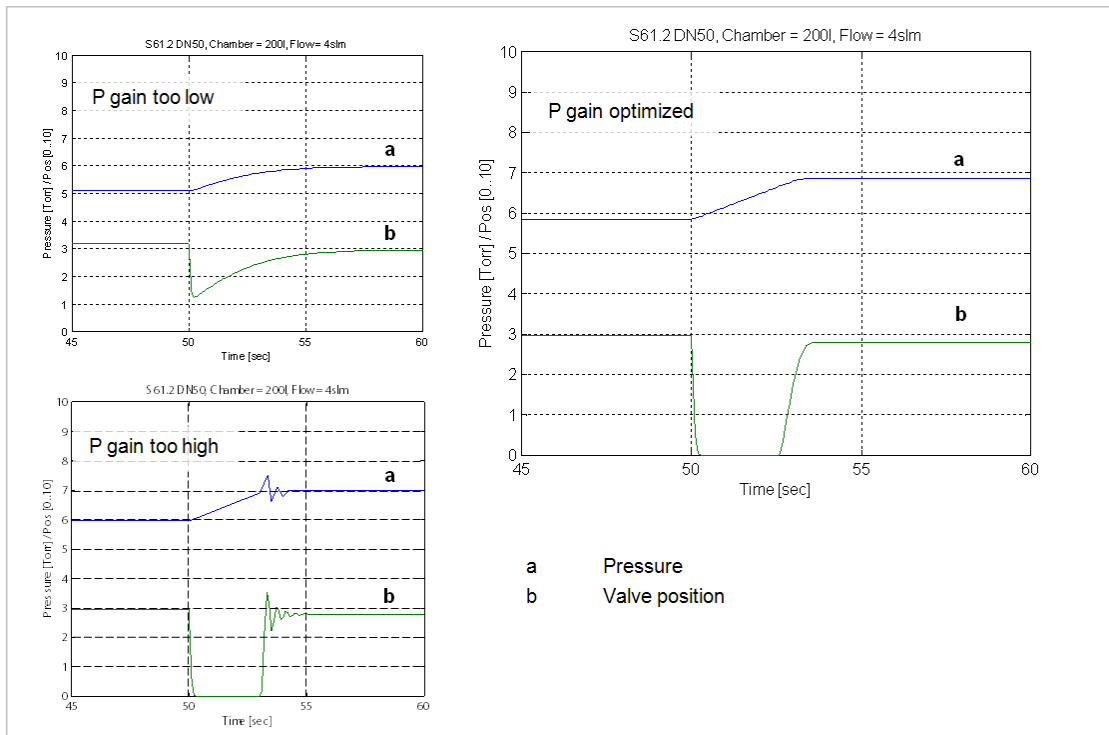

1.3 Optimizing I gain

While optimizing I gain, the gas flow determined above has to be constant all the time.

Start with P gain set to half of the value found when optimizing P gain and set I gain to 1.0. Keep the P gain constant.

Set chamber pressure to SP2, wait until the pressure is stable. Set pressure to SP1. If the transition from SP2 to SP1 results in a significant pressure overshoot or if the valve position does not stabilize, I gain is too high. If the transition results in a slow asymptotical pressure rise and there is still a constant deviation to SP2, the I gain is too low.

The optimal value for I gain is found if the transition from SP2 to SP1 results in just a slight pressure overshoot, a stable valve position and the actual pressure matches SP2 exactly.

Example:

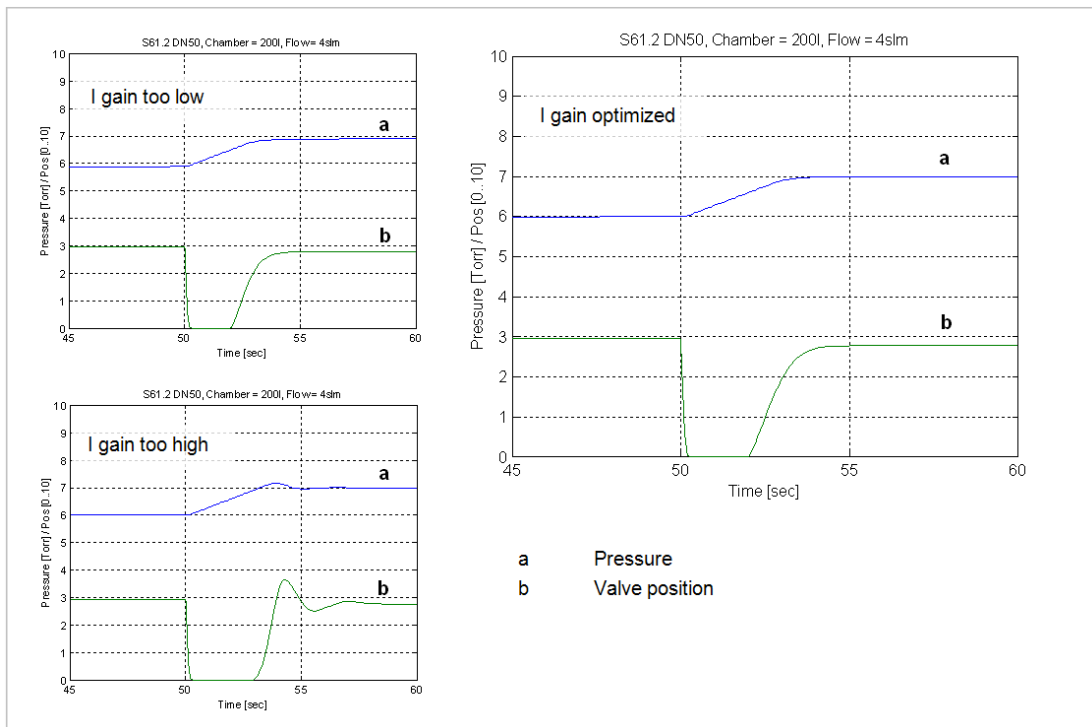

Check control performance over the whole control range with parameters above.

Required information for support:

- Go to 'Tools / Create Diagnostic File' in 'Control Performance Analyzer' and save file
- Pressure / flow / gas conditions to be controlled
- Chamber volume
- Pumping speed (l/s) and pump type (e.g. turbo pump)
- System description
- Problem description

Send diagnostic file with and all required information to tuning-support@vat.ch

4.9.4.3 Tuning of control performance with soft pump pressure controller

Optimizing P gain

This valve may be used to control pressure ramps during pump down. The P parameter of the pressure controller requires correct adjustment. This parameter must be set once during system setup and is stored in the device memory which is power fail save. Based on the soft pump controller configuration, the valve is able to run fast and accurate pressure control cycles. The P parameter can be evaluated using below instruction.

Introduction

Pump down control mode allows a completely user-defined pressure profile, usually from atmosphere down to some process pressure

1. Optimizing P gain

The P gain value evaluated for soft pump control mode might be different than the P gain value evaluated for PI controller mode. When switching to pump down control mode the P gain value evaluated for the PI controller has to be send to the valve controller. When switching back into PI controller mode the respective P gain value has to be send again. Adaptive pressure control mode ignores any P gain value.

1.1 Basic settings

The pump down characteristic is determined by start pressure, end pressure and pump down time. This straight line from start pressure to end pressure. The VAT soft pump controller requires a pump down time shorter than 10 sec. for good control results. If the required pump down time is longer than 10 sec., the pump down curve has to be partitioned into sections shorter than 10 sec. with corresponding end pressure.

Example:
 Start pressure: 760 Torr
 End pressure: 10 Torr
 Pump down time: 30 sec.

Here the pump down time and the corresponding pressure is being divided into three sections. The host sends a new pressure set point every 10 sec.:

Time	Set point
0 sec.	760 Torr
10 sec.	510 Torr
20 sec.	260 Torr
30 sec.	10 Torr

1.2 Optimizing P gain

WE start by setting the P gain to 1.0 as a trial value and adjust according to the response. The pump down routine has to be controlled as follows:

Move control valve into close position

Start pump down by opening the pump isolation valve or starting the pump and sending the first pressure set point to the valve controller. With the example above, the first pressure set point is 510 Torr.

At each new interval (exceeding 10 sec) send the new pressure set point.

Repeat until process pressure is achieved.

While pumping down chamber pressure and valve position should be data logged to compare the actual pump down curve with the ideal straight pump down line.

If the pressure follows the ideal pump down line with significant delay, the P gain is too low.

If the pressure oscillates around the ideal pump down line or if the valve position oscillates, P gain is too high.

P gain is optimized if the pressure follows the ideal pump down line closely and the valve position is not oscillating at all.

Example:

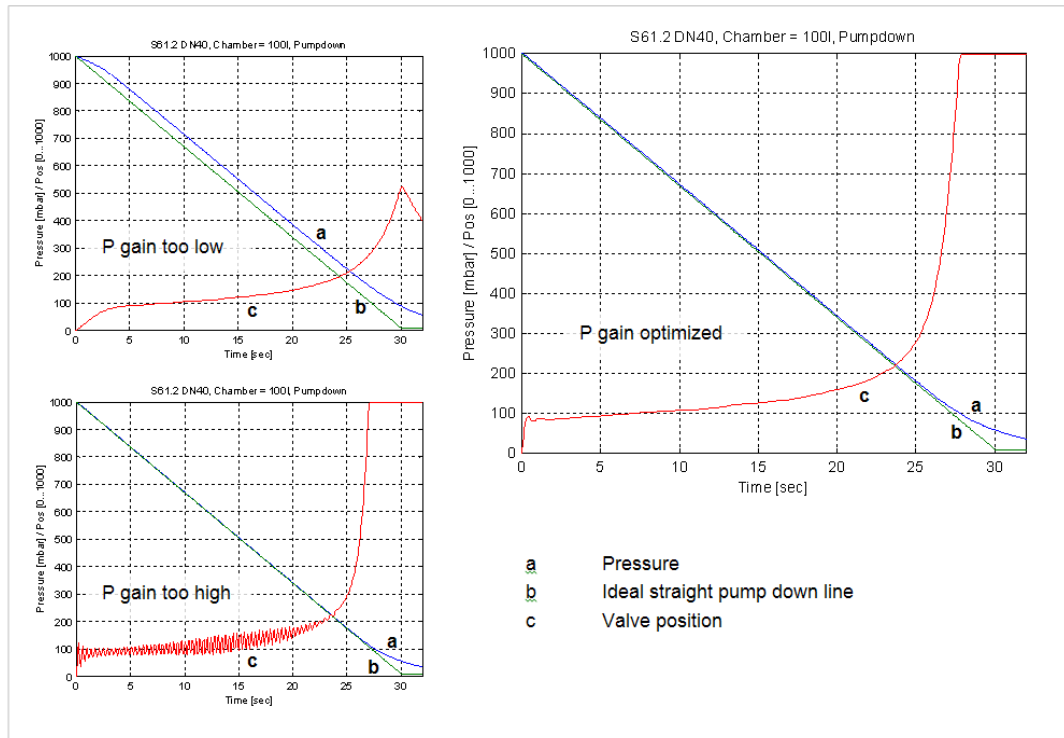





Required information for support:

- Go to 'Tools / Create Diagnostic File' in 'Control Performance Analyzer' and save file
- Pressure / flow / gas conditions to be controlled
- Chamber volume
- Pumping speed (l/s) and pump type (e.g. turbo pump)
- System description
- Problem description

Send diagnostic file with and all required information to tuning-support@vat.ch

5 Operation

	 WARNING
	<p>Unqualified personnel Inappropriate handling may cause serious injury or property damage. Only qualified personnel are allowed to carry out the described work.</p>

	 WARNING
	<p>Valve opening Risk of serious injury. Human body parts must be kept out of the valve opening and away from moving parts. Do not connect the controller to power before the valve is installed complete into the system.</p>

5.1 Normal operation

This valve is designed for downstream pressure control in vacuum chambers. It can be employed in a pressure control mode or a position control mode. In both cases local or remote operation is possible.

5.1.1 Remote operation

This product is equipped with a RS232 interface to allow for remote operation. See section «RS232 interface» for details. 'Control Performance Analyzer' software may be used for monitoring during remote control.

'Control Performance Analyzer' 4.0 software

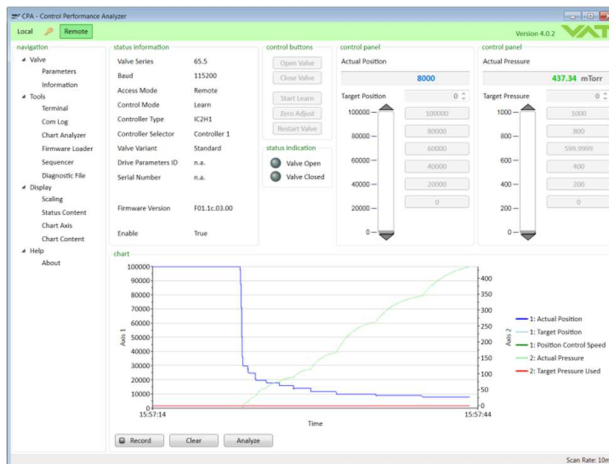

sample picture



In case 'Control Performance Analyzer' is used, make sure 'Remote' button is pushed to enable for remote operation.

5.1.2 Local operation

Local operation means that the valve is operated via the service port using a computer. You can use our software 'Control Performance Analyzer' for Local operation, which is integrated in the controller. The software is beneficial especially for setup, testing and maintenance.

How to start:

1. Connect service cable (USB A-B cable male-male) between PC and valve:

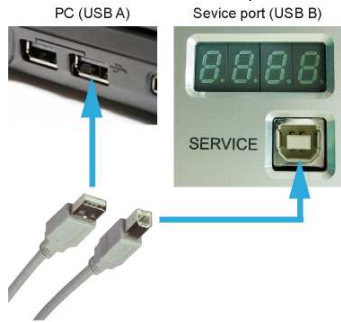

A drive opens:

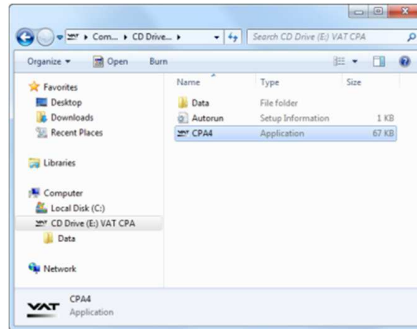

2. Double Click on 'CPA4.exe' to open the 'Control Performance Analyzer'

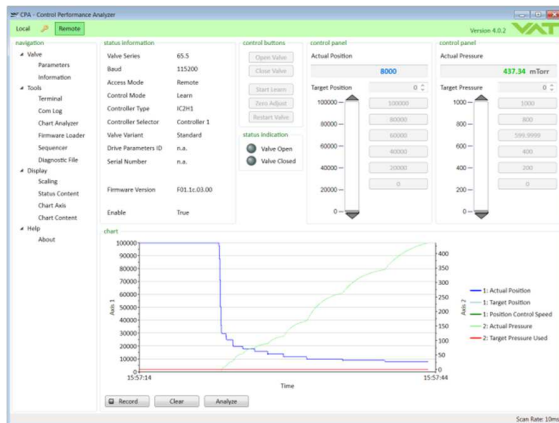

3. Click [Local] for Local operation to do configurations



When communication to service port is interrupted the valve will change to remote operation. So when service cable will be disconnected or software will be shut down, the valve returns automatically to remote operation. This may result in an immediate movement of the valve depending on remote control.

5.2 Close valve

Local operation: (‘Control Performance Analyzer’)	Remote operation: (Refer to chapter «OUTPUT Buffer» > «CONTROL MODE SETPOINT» for details)
Push CLOSE button	Refer to “Logic Interface” for details.

5.3 Open valve

Local operation: (‘Control Performance Analyzer’)	Remote operation: (Refer to chapter «OUTPUT Buffer» > «CONTROL MODE SETPOINT» for details)
Push OPEN button	Refer to “Logic Interface” for details.

5.4 Position control

The valve position is directly controlled according to the position setpoint.

Local operation: (‘Control Performance Analyzer’)	Remote operation: (Refer to chapter «OUTPUT Buffer» > «POSITION SETPOINT» for details)
Select or enter position setpoint	Refer to “Logic Interface” for details.

5.5 Pressure control



To prepare valve for PRESSURE CONTROL perform complete «Setup procedure». The valve has parameters that may be modified to tune pressure control performance. Refer to «Tuning of control performance».

The included PID controller controls the chamber pressure according to the pressure setpoint by means of the valve position. The PID controller works with an adaptive algorithm to achieve best results under altering conditions (gasflow, gas type).

Local operation: with ‘Control Performance Analyzer’ 4.0, refer to chapter: «Local operation»	Remote operation:
<ol style="list-style-type: none"> 1. Open the CPA 4.0 2. Click [Local] 3. Click [Parameters] 4. Click [Pressure Control] and do the settings 5. Click [Save] 	Refer to “Logic Interface” for details.

5.6 Display information

There is a 4 digit display located on the controller.
It displays configuration, status and position information.
For details refer to following tables.

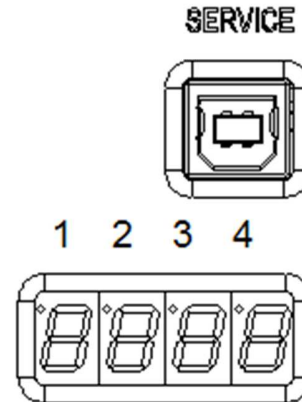

5.6.1 Power up

Description	Digit 1	Digit 2	Digit 3	Digit 4
• 1 st Power On: All dots are illuminated	#	#	#	#
• 2 nd information for about 3s Valve type [e.g.]		6	7	0
• 3 rd information for about 3s: Firmware generation and Firmware Type [e.g. 01.0C]	0	1	0	C
• 4 th information for about 3s: Firmware version and firmware revision [e.g. 07.00]	0	7	0	0
• 5 th information for about 3s: Controller configuration. [e.g. 11.00] Refer to «Safety mode» for details.	Controller Type (1=EC2)	Interface Type (1=RS232/RS485, 2=EtherCAT, 3=DeviceNet) 5=Logic	Option Type	
			0	0 (none)
			0	1 (SPS)
			0	2 (PFO)
			0	3 (Cluster)
			0	4 (SPS & PFO)
			0	5 (SPS & Cluster)
			0	6 (PFO & Cluster)
0	7 (SPS & PFO & Cluster)			

'Ho' indicates power up homing is running	H	o		
---	---	---	--	--

5.6.2 Operation

Description / Mode	Digit 1	Digit 2	Digit 3	Digit 4
Start up (init)	I	n	-	-
Start up (init) leak tight	I	n	-	C
Valve closed (leak tight)	C	-	-	C
Valve open	O	0...100 = valve position (0 = minimal conductance 100 = max. open)		
PRESSURE CONTROL mode	P			
POSITION CONTROL mode (e.g. A..0 = min. conductance)	A			
Closed / open interlock (Valve closed / open by digital input)	I			
HOLD (position frozen) activated	H			
LEARN running	L			
Safety mode established. Refer to «Safety mode» for details.	S			
Power failure	F			

5.6.3 Error

Description	Digit 1	Digit 2	Digit 3	Digit 4
Error number (xyz)	E	x	y	z
alternately (if error code exist)				
Error code	-	u	v	w



For Error number / code. Refer to «Trouble shooting» for details

5.6.4 Safety mode

By means of an external switch (see connection diagrams «Electrical connection») the motor power supply can be interrupted. In this case the valve enters the 'safety mode'. This motor interlock prevents the valve from moving (e.g. maintenance work). Data reading from the control unit remains possible. When motor interlock is active during power up the valve directly enters the 'safety mode' and is not able to do homing. Display shows 'S.XXX' (XXX = value position of valve or C..C for close). In this case homing cycle will be done when motor interlock is deactivated. Then Display shows 'Ho' (Homing) for a moment followed by 'A. 0'

When 'safety mode' is entered from operation (i.e. pressure control mode), the unit will automatically switch to position control mode and remain at current position. Once motor interlock is deactivated the unit remains in position control mode.

5.7 Operation during power up

Valve position before power up:	Reaction of valve:	
	Valve power up configuration = closed (default)	Valve power up configuration = open
Closed (isolated)	Valve remains closed. Display shows 'C C'. Homing will be done when first movement command is received.	Valve runs to maximum throttle position to detect the limit stops to do homing. Display shows configuration of product resp. 'Ho' until homing is done. Valve position after power up is 'A. 0' min. conductance.
All other than closed (not isolated)	Valve runs to max. throttle position to detect limit stop for homing. Display shows configuration of product resp. 'Ho' until homing is done, and afterwards to close position. Display shows 'C C'.	
	Valve position after power up is closed	Valve position after power up is open

Refer also to chapter: «Display information».

5.8 Behavior in case of power failure

Valve position before power failure:	Reaction of valve:	
	Without Power Failure Option (PFO)	With Power Failure Option (PFO)
	653 G	653 H
	653 A	653 C
	653 T	653 U
	653 V	653 W
Closed (isolated)	Valve remains closed.	Valve will close or open depending on valve configuration 1). Default is not defined. Display indicates F .
Valve open or in any intermediate position	Sealing ring moves down and blocks the pendulum plate at the current position.	

1) Provide that battery pack of the VAT controller is charged. Charging time after power up is 2 minutes max..



All parameters are stored in a power fail save memory.

5.9 Operation under increased temperature

	⚠ CAUTION
	<p>Hot valve</p> <p>Heated valve may result in minor or moderate injury.</p> <p>Do not touch valve and heating device during operation. Once heating is switched off (valve and system) await until the valve is cooled down complete before doing any work.</p>



This valve may be operated in the temperature range mentioned in chapter «Technical data».

5.10 Behavior In case of compressed air pressure drop

Valve position before pressure drop:	Reaction of valve:
Valve closed	Valve remains closed.
Valve open or in any intermediate position	Sealing ring moves down and blocks the pendulum plate at the current position.



Refer to chapter: «Troubleshooting» for details.

6 Trouble shooting

6.1.1 Controller Display

Description	Digit 1	Digit 2	Digit 3	Digit 4
Error number (xyz)	E	x	y	z
alternately (if error code exist)				
Error code	-	u	v	w

6.1.2 Error numbers



Error numbers are three-digit decimal numbers (**xyz**) whereas:

x = component	y = mode	z = error type
1 = All Motor Units 2 = Motor Unit 1 3 = Motor Unit 2 8 = Other	0 = Homing 2 = Operation Mode 8 = Other	0 = Position Error ¹⁾ 1 = Not running: No communication with component x 2 = Error State: component x is running but in Status Error 8 = Other

¹⁾ Only in combination with component 1, 2, 3

6.1.3 Error code

Error Code	Description			Solution	
	u	v	w		
			1	No valve connected	Connect valve controller to the valve
			2	Non volatile memory failure	Replace valve controller
			3	Analog digital converter of sensor input failure	Replace valve controller
			4	Initialization of motion controller failed	<ul style="list-style-type: none"> Wrong motion controller firmware version → Update motion controller firmware
			5	Encoder index pulse not found	<ul style="list-style-type: none"> Encoder failure O-Ring sticking 1)
			6	Initialization of interface module failed	<ul style="list-style-type: none"> Fieldbus: Valve firmware does not support interface type → Update valve firmware Wrong interface firmware version → Update interface firmware
	1		0	Closing position can't be reached	<ul style="list-style-type: none"> 1)
	1		1	Homing position can't be reached	<ul style="list-style-type: none"> 1)
	1		2	Motion controller: Internal voltage error	<ul style="list-style-type: none"> Check power supply
	1		3	Motion controller: Internal error temperature	<ul style="list-style-type: none"> Check for a heat accumulation
	1		4	Motion controller: Unexpected behavior	Contact vat support

			<ul style="list-style-type: none"> • Achsen vertauscht • Encoder nicht angeschlossen
1	5	Motion controller: Target position can't be reached	<ul style="list-style-type: none"> • 1) • Current settings
1	6	Motion controller: Position minimal conductance cannot be reached	<ul style="list-style-type: none"> • 1) • Check Plate and Seal ring • Check Parameter "Isolation Position Enter [r]"
1	7	Motion controller: Position to push back the Differential Plate cannot be reached	<ul style="list-style-type: none"> • 1) • Check Different Plate • Check Parameter "Differential Plate Push Back Position [r]"
1	8	Motion controller: Minimal isolation position cannot be reached	<ul style="list-style-type: none"> • 1) • Check Plate and Seal ring • Check Parameter "Isolation Position [r]"
2	0	Break slippery detected	Replace actuator
3	0	SFV: Motion controller failure in master-slave communication	Contact vat support
4	0	Compressed air error	Check compressed air
4	2	Power supply, low voltage detected	Check if power supply is ok and is able to deliver needed power
9	6	SFV: Position deviation axis1 to axis2 at homing procedure	<ul style="list-style-type: none"> • O-Ring sticking • 1)
9	7	SFV: Position deviation axis1 to axis2 at operating	1)
9	8	Position error during closing procedure	1)
9	9	Position error at operating	1)
2	0	0	Valve configuration error, not possible to operate the valve with these configuration
7	7	7	Do not operating mode active

1) Mechanical movement problem:

- Check for differential pressure
- Remove foreign object in movement area
- Eliminate tight movement
- Repair mechanical failure



If you need any further information, please contact one of our service centers. You will find the addresses on our website: www.vatvalve.com.

7 Maintenance

	<p style="text-align: center;">WARNING</p> <p>Unqualified personnel Inappropriate handling may cause serious injury or property damage. Only qualified personnel are allowed to carry out the described work.</p>
	<p style="text-align: center;">WARNING</p> <p>Valve opening Risk of serious injury. Human body parts must be kept out of the valve opening and away from moving parts. Disconnect power on controller before doing any work.</p>
	<p style="text-align: center;">CAUTION</p> <p>Hot valve Heated valve may result in minor or moderate injury. Do not touch valve and heating device during operation. Once heating is switched off (valve and system) await until the valve is cooled down complete before doing any work.</p>
	<p style="text-align: center;">NOTICE</p> <p>Contamination Gate and other parts of the valve must be protected from contamination. Always wear clean room gloves when handling the valve.</p>

7.1 Maintenance intervals

Under clean operating conditions, the valve does not require any maintenance during the specified cycle life. Contamination from the process may influence the function and requires more frequent maintenance.

Before carrying out any maintenance, please contact VAT. It has to be individually decided whether the maintenance can be performed by the customer or has to be carried out by VAT. Please write down the fabrication number of the valve before contact VAT. Refer to chapter «Identification of product» for fabrication number.

7.2 Maintenance procedures

Two maintenance procedures are defined for this valve. These are:

- **Replacement of isolation seals** (gate and body seal of sealing ring) **and valve cleaning**
- **Replacement of actuator shaft seals**



Required frequency of cleaning and replacement of seals is depending on process conditions.

VAT can give the following recommendations for preventive maintenance:

Replacement of	unheated ¹⁾	heated ≤ 80 °C ¹⁾	heated > 80 °C ¹⁾
isolation seals (gate and body seal of sealing ring)	12 month but max. 200'000 cycles	6 months but max. 200'000 cycles	3 months but max. 200'000 cycles
actuator shaft seals	1'000'000 cycles	6 months	3 months



¹⁾ Those figures are reference values for clean conditions under various temperatures. These values do not include any impact of the process. Therefore preventive maintenance schedule has finally to be checked for the actual process conditions.

NOTICE	
	<p>Vacuum grease</p> <p>Vacuum grease may be distributed and contaminate the valve.</p> <p>Prevent gap between body and sealing ring from air gun cleaning. Do not clean the gap between body and sealing ring with compressed air.</p>



See figure below:





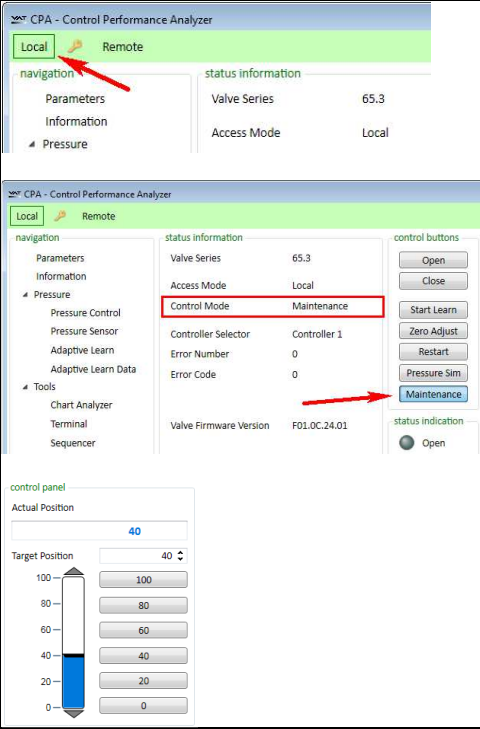

7.2.1 Replacement of isolation seals and valve cleaning

7.2.1.1 Required tools

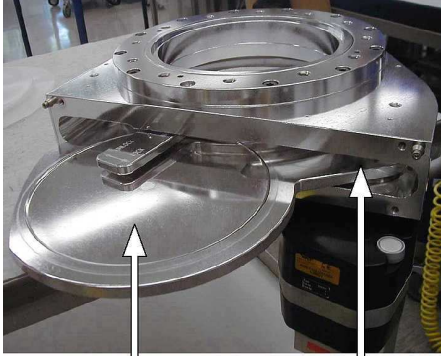
- Allen Wrench 5mm
- Open end wrench 13mm
- Service cable USB Type A to B (PC to valve Service connector)
- Clean room wiper
- Vacuum grease (see chapter spare parts)
- O-ring removal tool (see chapter Accessories)
- Isopropyl alcohol

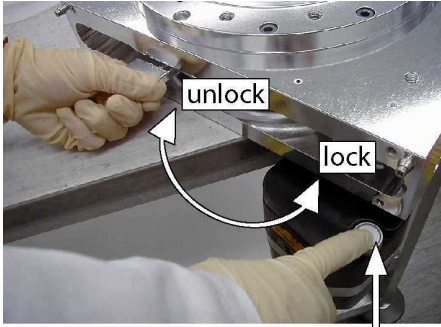
Description	Required tool
 <p>Electrical power and compressed air is required to perform steps 1 to 11 during disassembly respectively 11 to 1 during assembly.</p>	
<p>1. Set the valve to local mode</p> <p>2. Activate "Maintenance" (reduced speed)</p> <p>Now us the position buttons to move the valve plate. The valve will now move in a very low speed</p> <p>Alternatively, the remote interface can be used:</p> <p style="padding-left: 40px;">Set "Control Mode" to 'Maintenance'</p> <p style="padding-left: 40px;">Now use "Target Position" to move the valve</p>	 <p>Service cable (PC to valve Service connector)</p>
<p>3. Vent both valve chambers.</p> <p>4. Open the 4 bonnet screws and remove valve bonnet.</p>	 <p>Allen wrench 5mm</p>

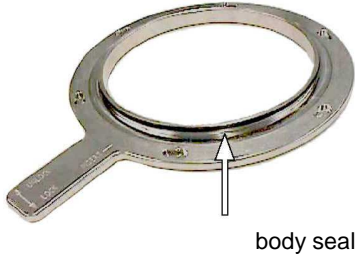
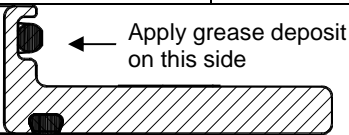

Description	Required tool	
<p>5. Open valve  Stand away from valve – pendulum plate moves out of the valve body.</p> <p>6. Unfasten mounting screw for pendulum plate.</p> <p>7. Remove pendulum plate.</p>	 <p>pendulum plate mounting screw for pendulum plate</p>	<p>Open end wrench 13mm</p>
<p>8. With one hand press the MAINTENANCE BUTTON to lower the sealing ring, with your second hand unlock the sealing ring by pressing the handle.</p> <p>9. Release MAINTENANCE BUTTON.</p> <p>10. Remove sealing ring.</p> <p>11. To prevent the shaft and retaining pins from moving during work, switch the valve to safety mode. Refer to «Safety mode» for details.</p> <p> Retaining pins will move up.</p>	 <p>unlock lock</p> <p>maintenance button</p>	
<p>12. Remove gate and body o-ring from sealing ring carefully with a soft tool.</p> <p>13. Remove grease residues at sealing ring with alcohol. Clean sealing ring and pendulum plate with alcohol or in an ultrasonic bath.</p> <p>14. Clean out valve body with alcohol. Use an appropriate non metal tool with a cloth to enter valve body. Do not enter valve body with hands! Then blow out valve body with clean air.</p>	 <p>gate seal</p>	



Description		Required tool										
<p>Do not directly expose seals (actuator and retaining pin feedthroughs) to air stream!</p> <p>15. Clean or replace gate seal if necessary. Install gate o-ring to sealing ring without grease.</p>												
<p>16. Clean or replace body seal if necessary. Lubricate body with the quantity of vacuum grease listed in the table to the right.</p>	<table border="1"> <thead> <tr> <th>Valve size</th> <th>Quantity of grease [ml]</th> </tr> </thead> <tbody> <tr> <td>DN 100</td> <td>0.1</td> </tr> <tr> <td>DN 160</td> <td>0.15</td> </tr> <tr> <td>DN 200</td> <td>0.2</td> </tr> <tr> <td>DN 250</td> <td>0.2</td> </tr> </tbody> </table>	Valve size	Quantity of grease [ml]	DN 100	0.1	DN 160	0.15	DN 200	0.2	DN 250	0.2	<p>Soft tool (o-ring remover)</p> <p>Vacuum grease</p>
	Valve size	Quantity of grease [ml]										
	DN 100	0.1										
	DN 160	0.15										
DN 200	0.2											
DN 250	0.2											
<p>17. Install body seal into sealing ring.</p>												
<p>18. Deposit vacuum grease on the bottom side of the body seal according to drawing below. Pay attention that the quantity of vacuum grease listed in the table to the right is distributed constantly over the whole circumference.</p>	<table border="1"> <thead> <tr> <th>Valve size</th> <th>Quantity of grease [ml]</th> </tr> </thead> <tbody> <tr> <td>DN 100</td> <td>0.2</td> </tr> <tr> <td>DN 160</td> <td>0.25</td> </tr> <tr> <td>DN 200</td> <td>0.3</td> </tr> <tr> <td>DN 250</td> <td>0.4</td> </tr> </tbody> </table>	Valve size	Quantity of grease [ml]	DN 100	0.2	DN 160	0.25	DN 200	0.3	DN 250	0.4	<p>Vacuum grease</p>
	Valve size	Quantity of grease [ml]										
	DN 100	0.2										
	DN 160	0.25										
DN 200	0.3											
DN 250	0.4											
		<p>Vacuum grease</p>										
<p>19. Reassembly the valve in reverse order, step 9...3.</p> <p>20. Close the valve bonnet, see steps 31...33.</p>												
<p>21. Mount valve bonnet.</p> <ul style="list-style-type: none"> Tightening torques for bonnet screws, see in table to the right. 	<p>Max. torque 6 Nm</p>	<p>Allen wrench 5mm</p>										
<p>22. To leave the maintenance mode press "Restart" button or power cycle the controller.</p> <p>23. Set the valve to remote mode</p>		<p>CPA & Service cable (PC to valve Service connector)</p>										

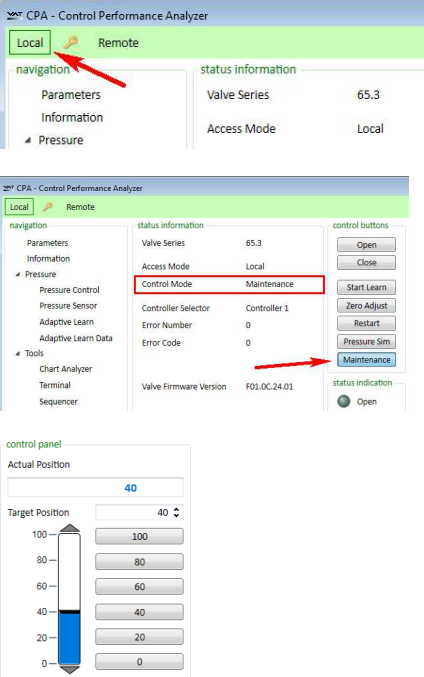

7.2.2 Replacement of actuator shaft seals

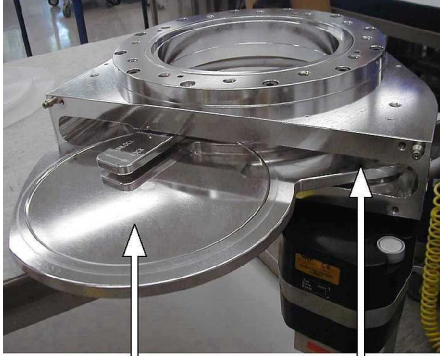

7.2.2.1 Required tools

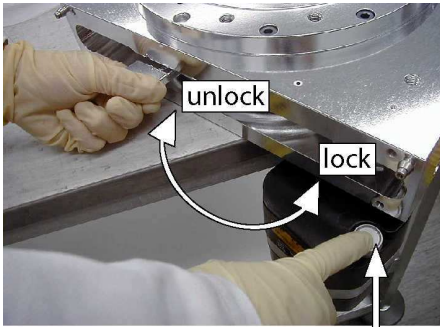

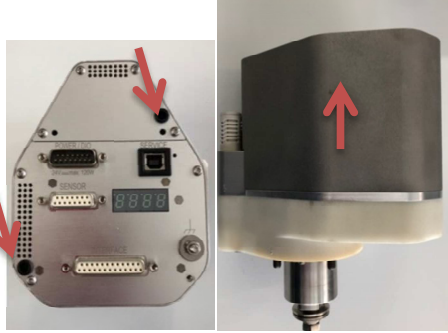
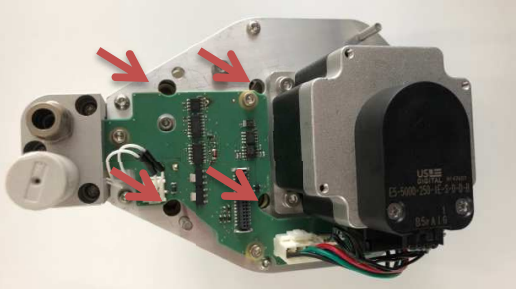

- Allen Wrench 2mm
- Allen Wrench 4mm
- Allen Wrench 5mm
- O-ring removal tool (see chapter Accessories)
- Vacuum grease (see chapter spare parts)
- Open end wrench 13mm
- Clean room wiper
- Isopropyl alcohol
- Service cable USB Type A to B (PC to valve Service connector)

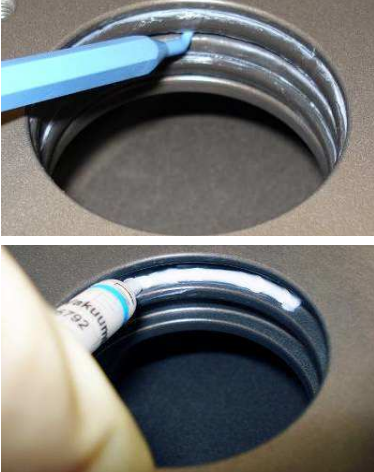
Description	Required tool
 <p>Electrical power and compressed air is required to perform steps 1 to 11 during disassembly respectively 11 to 1 during assembly.</p>	
<p>1. Set the valve to local mode</p> <p>2. Activate "Maintenance" (reduced speed)</p> <p>Now us the position buttons to move the valve plate. The valve will now move in a very low speed</p> <p>Alternatively, the remote interface can be used:</p> <p>Set "Control Mode" to 'Maintenance'</p> <p>Now use "Target Position" to move the valve</p>	 <p>CPA & Service cable (PC to valve Service connector)</p>
<p>3. Vent both valve chambers.</p> <p>4. Open the 4 bonnet screws and remove valve bonnet.</p>	 <p>Allen wrench 5mm</p>

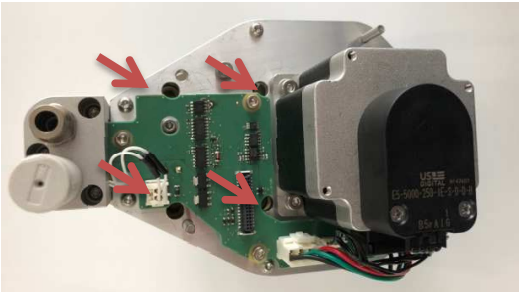
Description	Required tool
<p>5. Open valve</p> <p> Stand away from valve – pendulum plate moves out of the valve body.</p> <p>6. Unfasten mounting screw for pendulum plate.</p> <p>7. Remove pendulum plate.</p>	 <p>pendulum plate mounting screw for pendulum plate</p>
<p>8. With one hand press the MAINTENANCE BUTTON to lower the sealing ring, with your second hand unlock the sealing ring by pressing the handle.</p> <p>9. Release MAINTENANCE BUTTON.</p> <p>10. Remove sealing ring.</p> <p>11. To prevent the shaft and retaining pins from moving during work, switch the valve to safety mode. Refer to «Safety mode» for details.</p> <p> Retaining pins will move up.</p>	 <p>unlock lock</p> <p>maintenance button</p>
<p>12. Release the valve from safety mode. Refer to «Safety mode» for details</p> <p>13. Move the valve to position 50% (half opened) This is necessary, in order to dismount the actuator. See step 15.</p> <p>14. Disable PFO option feature via 'Power Fail Status' in menu 'System' of CV or CPA software, and turn off the power</p>	<p>• CPA software</p>

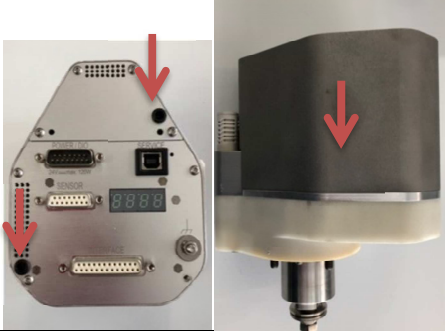
Description	Required tool
<p>15. Disconnect 24VDC power. Wait for 60s, then disconnect cables and compressed air from valve actuator.</p> <p>16. Unfasten all 2 controller screws and lift controller carefully from actuator.</p>	 <p>Allen Wrench 4 mm</p>
<p>17. Unfasten all 4 actuator screws and remove actuator.</p>	 <p>Allen Wrench 5 mm</p>
<p>18. Replace pressed air gasket</p>	 <p>927458</p>

Description	Required tool
<p>19. Remove actuator shaft seals carefully with a soft tool.</p> <p>20. Clean actuator feedthrough with alcohol.</p> <p>21. Lubricate each o-ring groove with 0.1 ml vacuum grease. Pay attention that grease is distributed constantly over the whole circumference.</p>	 <p>Soft tool (o-ring remover)</p> <p>Vacuum grease</p>
<p>22. Clean or replace seals if necessary. Lubricate each o-ring with 0.05 ml vacuum grease.</p> <p>23. Install o-rings.</p> <p>24. Deposit 0.1 ml vacuum grease on each o-ring. Pay attention that grease is distributed constantly over the whole circumference.</p>	 <p>Vacuum grease</p>
<p>25. Remove fixation kit and mounting screw for pendulum plate.</p> <p>26. Clean screw and slightly lubricate thread. Then reinstall fixation kit.</p> <p>27. Clean actuator shaft and lubricate it with 0.1 ml vacuum grease.</p>	 <p>Vacuum grease</p>
<p>28. Install actuator</p> <ul style="list-style-type: none"> • Tighten actuator screws with 10 Nm. • Remove vacuum grease from actuator shaft face after installation. 	 <p>Allen Wrench 5mm</p>

<p>29. Install controller</p> <ul style="list-style-type: none"> • Tighten the controller screws with 3 Nm. • Connect cables at controller • Connect compressed air at actuator 		<p>Allen Wrench 4mm</p>
<p>30. Turn on power of controller.</p> <p> Valve moves to close position.</p> <p>31. Open valve and install sealing ring and pendulum plate in reverse order as they had been disassembled (steps 11 to 2).</p>		<p>open end wrench 13mm</p>
<p>32. Clean the valve sealing surface</p>		<p>Lint-and dust-free towel a little soaked with isopropyl alcohol</p>
<p>33. Clean the valve bonnet o-ring</p>		<p>Lint-and dust-free towel</p>
<p>34. Mount valve bonnet.</p> <ul style="list-style-type: none"> • Tightening torques for bonnet screws, see in table to the right. 	<p>Max. torque 6 Nm</p>	<p>Allen wrench 5mm</p>
<p>35. To leave the maintenance mode press "Restart" button or power cycle the controller.</p> <p>36. Set the valve to remote mode</p>		<p>CPA & Service cable (PC to valve Service connector)</p>

7.2.3 Replacement of Option board

	NOTICE
	<p>Electrostatic discharge</p> <p>Electronic components could be damaged.</p> <p>All work on the control and actuating unit has to be done under ESD protected environment to prevent electronic components from damage.</p>

	NOTICE
	<p>Burned connector pins (spark)</p> <p>Connector pins or electronic parts could be damaged, if plugged and unplugged under power.</p> <p>Do not plug or unplug connectors under power.</p>

The option board may or may not be equipped in your valve depending on the order. Refer to page 1 of this manual to check valve version. This board includes the optional modules for the valve which are:

- ± 15 VDC sensor power supply (SPS)
- Power failure option (PFO)

It is available in 3 versions. These are:

- SPS module only
- PFO module only
- SPS and PFO module

The modules may be retrofitted or replaced easily. The battery lifetime of the PFO module depends on the ambient temperature (see below). To assure PFO function the option board must be replaced after battery life has expired. For ordering number of the modules refer to chapter «Spare parts».

7.2.3.1 Durability of power fail battery

The curves in the graph show the estimated life of Ultra Cap PFO in the worst condition (max. sensor load = 1 A, valve heating temperature = 150 °C).

If the SPS is not fully loaded (< 1 A) or heating temperature of valve body is lower than 150 °C, the corresponding life time curve will be somewhere in between the upper and the lower curve.

Therefore please determine the equivalent maintenance period for replacing the Ultra Cap battery (Option board).

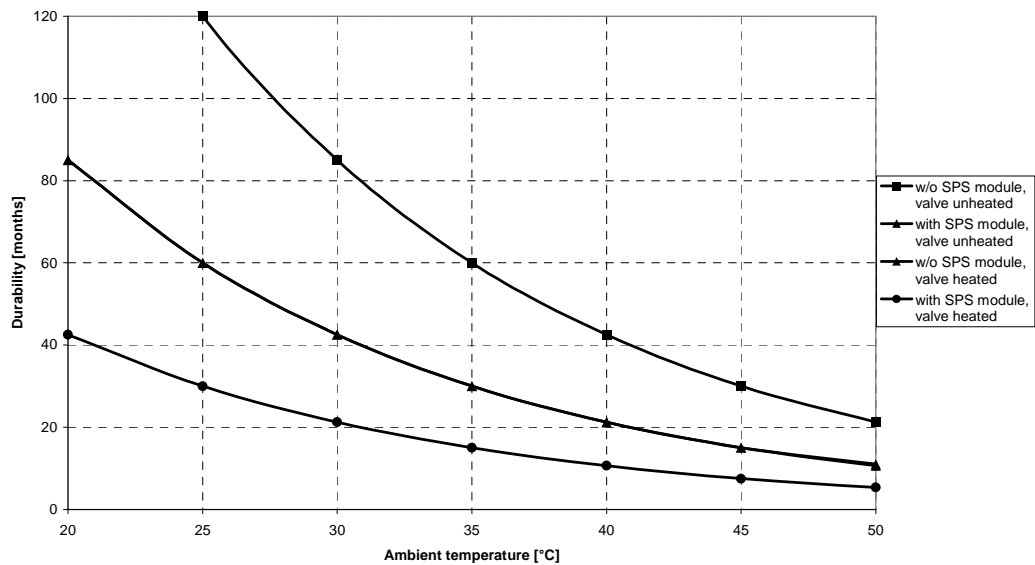

This graph shows estimated life of Ultra Cap PFO for reference and not as guaranteed value.

7.2.4 Retrofit / replacement procedure

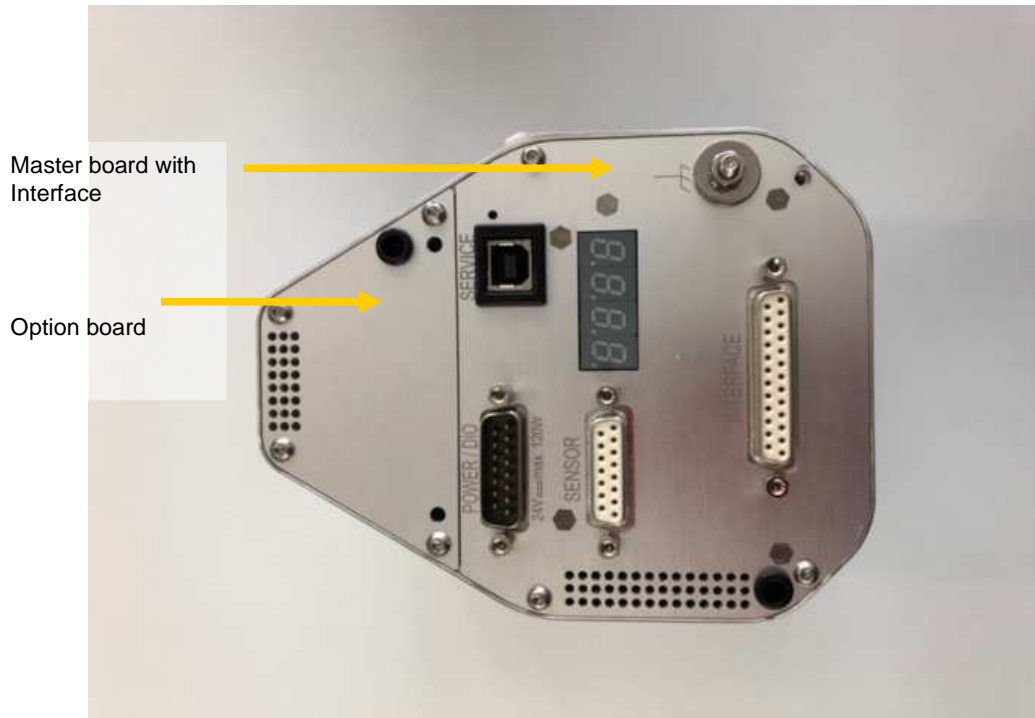

Top view on control and actuating unit with panel removed:



All boards have a fixed position into control and actuating unit. It is not possible to fit a board in other position as shown in picture above! Do not try out other positions, which maybe destroy the socket of boards!

7.2.4.1 Required tools

- Pozidriv screw driver size 1
- Open end wrench 4.5mm

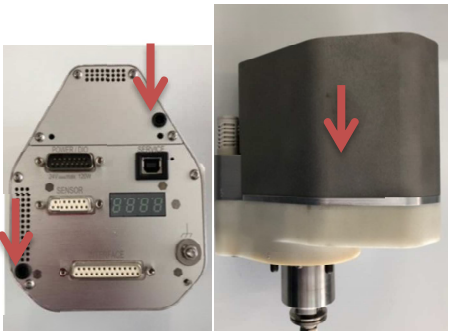
Description	Required tool
<ol style="list-style-type: none"> 1. Disconnect 24VDC power. Wait for 60s, then disconnect cables and compressed air from valve actuator. 2. Unfasten all 2 controller screws and lift controller carefully from actuator. 	
<ol style="list-style-type: none"> 3. Place Option board from behind in the controller. 4. Tighten option board with the 2 screws with 1.1Nm. 	
<ol style="list-style-type: none"> 5. 6. Fasten all 2 controller screws and lift controller carefully from actuator. 7. Connect cables and compressed air to valve actuator. 	



If you need any further information, please contact one of our service centers. You can find the addresses on our website: www.vatvalve.com.

8 Repairs

Repairs may only be carried out by the VAT service staff. In exceptional cases, the customer is allowed to carry out the repairs, but only with the prior consent of VAT.

Please contact one of our service centers. You will find the addresses on our website www.vatvalve.com.

9 Dismounting and Storage

	⚠ WARNING
	Unqualified personnel Inappropriate handling may cause serious injury or property damage. Only qualified personnel are allowed to carry out the described work.

9.1 Dismounting

	NOTICE
	Contamination Gate and other parts of the valve must be protected from contamination. Always wear clean room gloves when handling the valve.

	NOTICE
	Valve in open position Valve body may become damaged if valve gate is in open position. Move valve gate to the closed position before dismantling the valve.

1. Close the valve
2. For dismantling the valve please follow the instructions of chapter: «Installation», however in reverse order.

9.2 Storage

NOTICE	
	<p>Wrong storage</p> <p>Inappropriate temperatures and humidity may cause damage to the product.</p> <p>Valve must be stored at:</p> <ul style="list-style-type: none">– relative humidity between 10% and 70%– temperature between +10 °C and +50 °C– non-condensing environment

NOTICE	
	<p>Inappropriate packaging</p> <p>Product may get damaged if inappropriate packaging material is used.</p> <p>Always use the original packaging material and handle product with care.</p>

1. Clean / decontaminate valve.
2. Cover all valve openings with a protective foil.
3. Pack valve appropriately, by using the original packaging material.

10 Packaging and Transport

	⚠ WARNING
	<p>Unqualified personnel</p> <p>Inappropriate handling may cause serious injury or property damage. Only qualified personnel are allowed to carry out the described work.</p>

	⚠ WARNING
	<p>Harmful substances</p> <p>Risk of injury in case of contact with harmful substances. Remove harmful substances (e. g. toxic, caustic or microbiological ones) from valve before you return the valve to VAT.</p>

	NOTICE
	<p>Inappropriate packaging</p> <p>Product may get damaged if inappropriate packaging material is used. Always use the original packaging material and handle product with care.</p>



- When returning products to VAT, please fill out the VAT form «Declaration of Chemical Contamination of Vacuum Valves and Components» and send it to VAT in advance. The form can be downloaded from our website www.vatvalve.com (Section: Services – Aftersales).
- If products are radioactively contaminated, the VAT form «Contamination and Radiation Report» must be filled out. Please contact VAT in advance.
- If products are sent to VAT in contaminated condition, VAT will carry out the decontaminating procedure at the customer's expense.

10.1 Packaging

	NOTICE
	<p>Valve in open position</p> <p>Valve mechanism may get damaged if valve is in open position. Make sure that the valve is closed.</p>

1. Cover all valve openings with a protective foil.
2. Pack valve appropriately, by using the original packaging material.



VAT disclaims any liability for damages resulting from inappropriate packaging.

10.2 Transport

NOTICE	
	<p>Inappropriate packaging Product may get damaged if inappropriate packaging material is used. Always use the original packaging material and handle product with care.</p>



VAT disclaims any liability for damages resulting from inappropriate packaging.

11 Disposal



WARNING

Unqualified personnel

Inappropriate handling may cause serious injury or property damage.
Only qualified personnel are allowed to carry out the described work.

12 Spare parts



NOTICE

Non-original spare parts

Non-original spare parts may cause damage to the product.
Use original spare parts from VAT only.



- Please specify the fabrication number of the product when you place an order for spare parts; see chapter: «Identification of product». This is to ensure that the appropriate spare parts are supplied.
- VAT makes a difference between spare parts that may be replaced by the customer and those that need to be replaced by the VAT service staff.
- The following table(s) contain spare parts that may be replaced by the customer. If you need any other spare parts, please contact one of our service centers. You will find the addresses on our website www.vatvalve.com.

12.1 Drawing

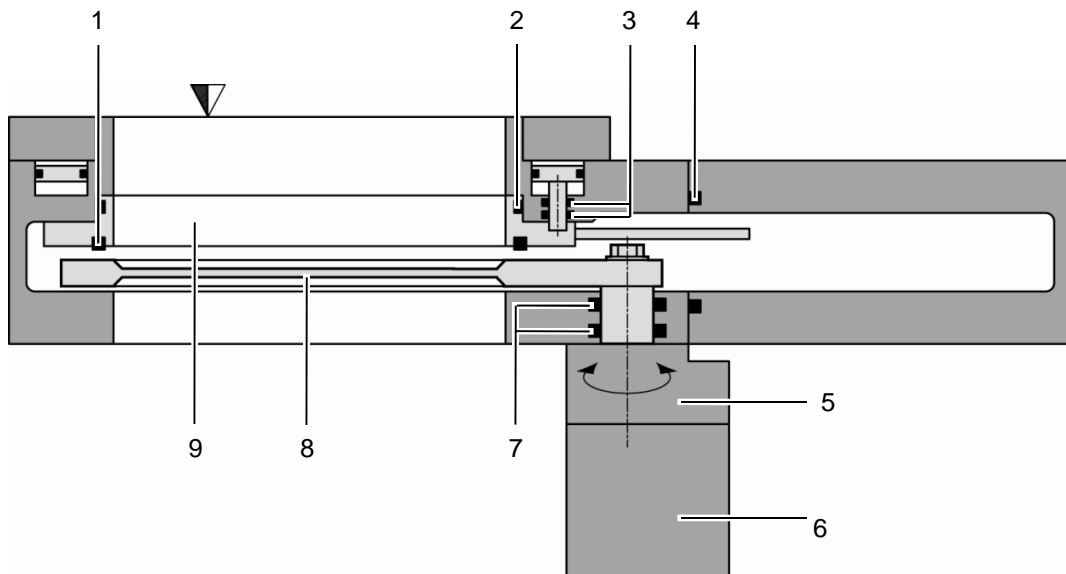

1	Plate seal	6	Integrated controller
2	Body seal	7	Rotary feedthrough seals
3	Shaft feedthrough seals	8	Pendulum plate
4	Bonnet seal	9	Sealing ring
5	Actuator		



All "Item" refer to chapter «Drawing»

12.1.1 Valve unit with seals and grease

Item	Description	DN100	DN160	DN200	DN250
	Valve size Valve part number	DN100 65340 -	DN160 65344 -	DN200 65346 -	DN250 65348 -
1	Bonnet Viton seal other materials	N-5100-259 on request	N-5100-267 on request	N-5100-272 on request	N-5100-277 on request
2	Body seal (Viton) This includes a 2ml syringe of vacuum grease	204884	206527	200468	202592
3	Gate Viton seal other materials	N-5100-155 on request	N-5100-258 on request	N-5100-266 on request	N-5100-275 on request
	Seal kit vacuum (Viton). This consists of item 2 and 3.	204883	206526	204204	203883
	Syringe of 2ml vacuum grease 5ml	206792 206793			
4	Actuator shaft seals (Viton) Actuator compressed air gasket	N-5100-326 (2 pcs required per valve) 927458			
5	Sealing ring shaft seals (Viton)	N-5111-112 (12 pcs required per valve)	N-5111-112 (12 pcs required per valve)	N-5111-112 (16 pcs required per valve)	N-5111-112 (16 pcs required per valve)
6	Pendulum plate: - Blank B1 *) - Blank B2 *) - Hardanodized B1 *) - Hardanodized B2 *) - Nickel coated B1 *) - Nickel coated B2 *)	on request on request on request on request on request on request	on request on request on request on request on request on request	on request on request on request on request on request on request	on request on request on request on request on request on request
7	Sealing ring - Blank - Hardanodized - Nickel coated	on request on request on request	on request on request on request	on request on request on request	on request on request on request
8	Actuator B1 *) B2 *)	on request on request	946358 on request		

*) Refer to figures on next page to check for actuator position options.



Use only spare parts manufactured by VAT to assure safe and reliable operation All "

Actuator position options:

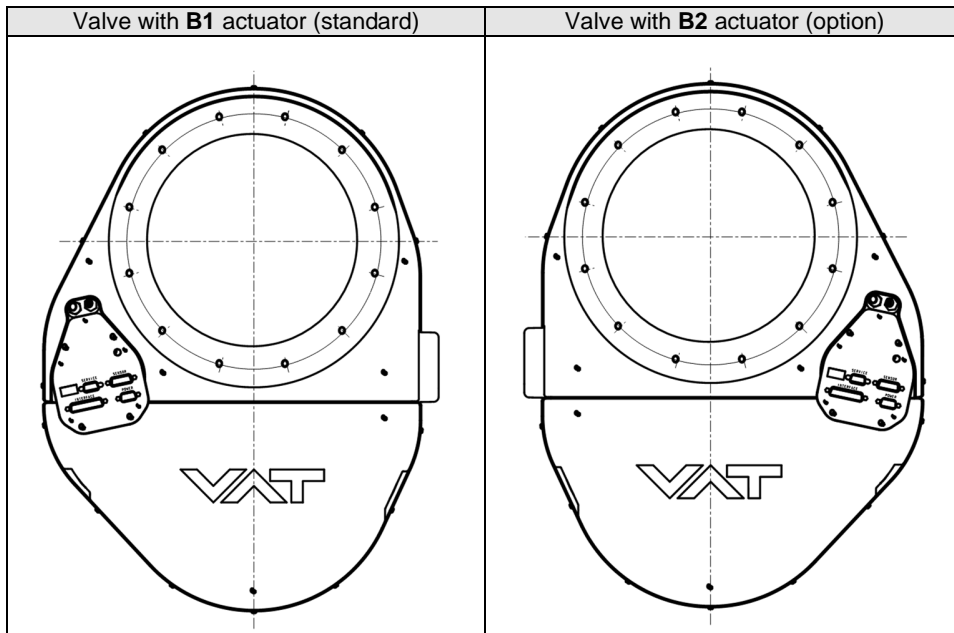

All "Item" refer to chapter «Drawing»

12.1.2 Control and actuating unit

Description	Part number
Control and actuating unit	Too many to list. Please contact VAT.
Option board with SPS module (±15 VDC Sensor Power Supply)	936205
Option board with PFO module (Power Failure Option)	936200
Option board with SPS and PFO module	936202

12.1.3 Accessories

Description	Part number
24 VDC power supply unit (input: 100 – 240 VAC)	891528
O-ring removal tool	234859
VAT valve cleaning tool	305709
Adapter cable for power supply with D-Sub9 connector	(735567) (D-Sub15 to D-Sub9)
Service cable (PC to valve Service connector)	809474 (USB A-B male-male)

12.1.3.1 Centering ring with Viton o-ring

		Description			
Valve size Product ordering number		DN 100 / 4" 65340 -	DN 160 / 6" 65344 -	DN 200 / 8" 65346 -	DN 250 / 10" 65348 -
Centering ring with Viton o-ring (for ISO-F installation only)	Aluminum	32040-QAZV	32044-QAZV	32046-QAZV	32048-QAZV
	Stainless steel	32040-QEZV	32044-QEZV	32046-QEZV	32048-QEZV

13 Appendix

No information entered on time.

This page left blank intentionally.