



RS232 / RS485 / Logic



Ether CAT



Device Net



Valve Cluster Slave
(without interface)



CC-Link



Profibus



Ether Net

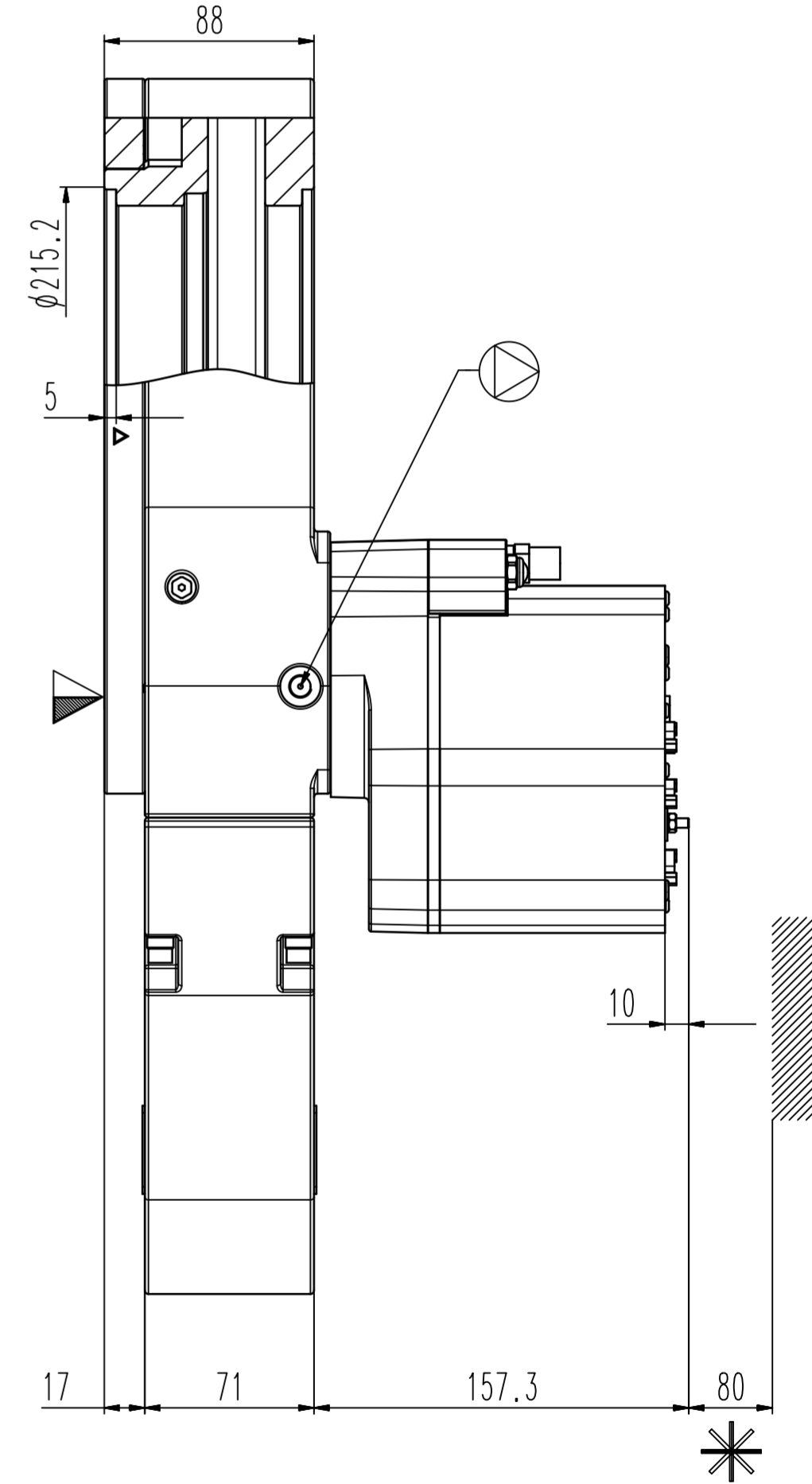
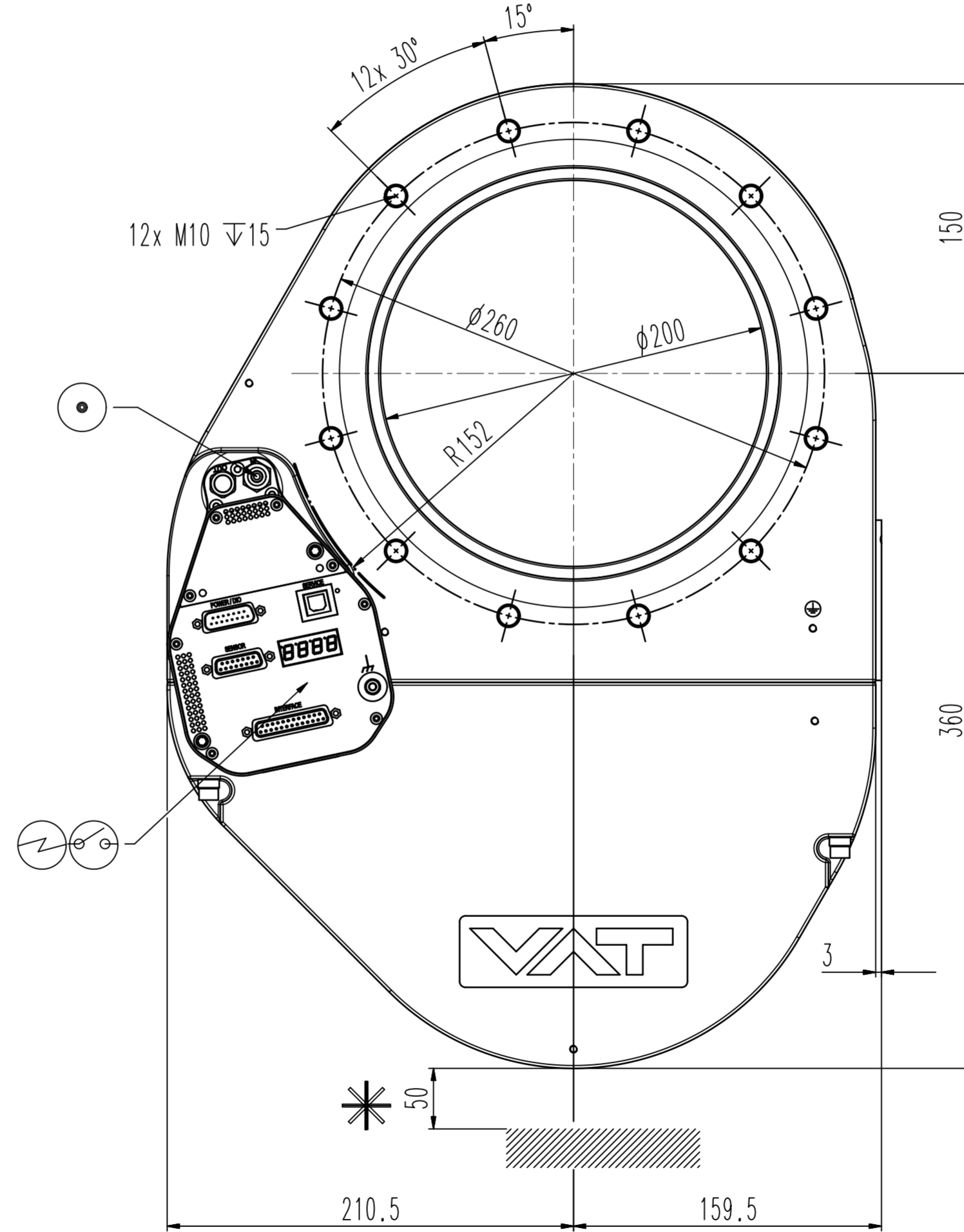
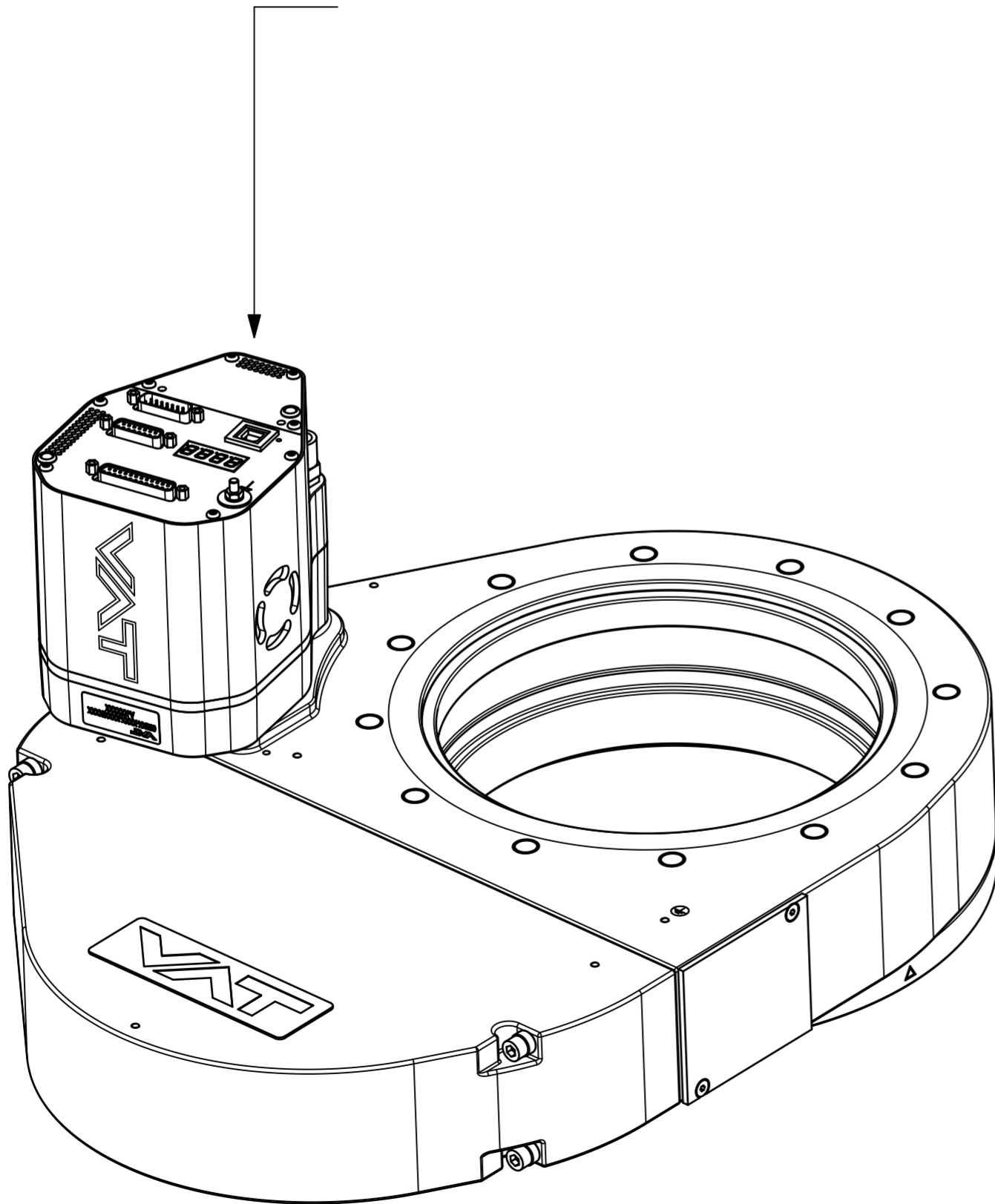

Revision

Customer number

- ▼ Seat side
- ⊙ Comp. air connection
- ⊙ Electrical connection
- ⊙ Leak detection port
- ⊙ Mech. pos. indication
- ⊙ Position indicator
- ⊙ Required for dismantling
- ⊙ Emergency actuation
- ⊙ For attachment
- ⊙ Bake-out area
- ⊙ Differential pumping port

Control pendulum valve

VAT VAT Vakuumventile AG
CH-9469 Haag, Switzerland
Tel: ++41 81 7716161 Fax: ++41 81 7714830

Rev.-Date: 27.06.24
Visa: TANK

| | | | |
|---------------------|---------|--------------|---------|
| Series | 653 | Ordering No. | ISO Std |
| Projection E | DN | Flange | |
| | 200 | | |
| Dimensional Drawing | 1297552 | Rev. | A |