



RS232 / RS485 / Logic



Ether CAT



Device Net



Valve Cluster Slave
(without interface)



CC-Link



Profibus



Ether Net

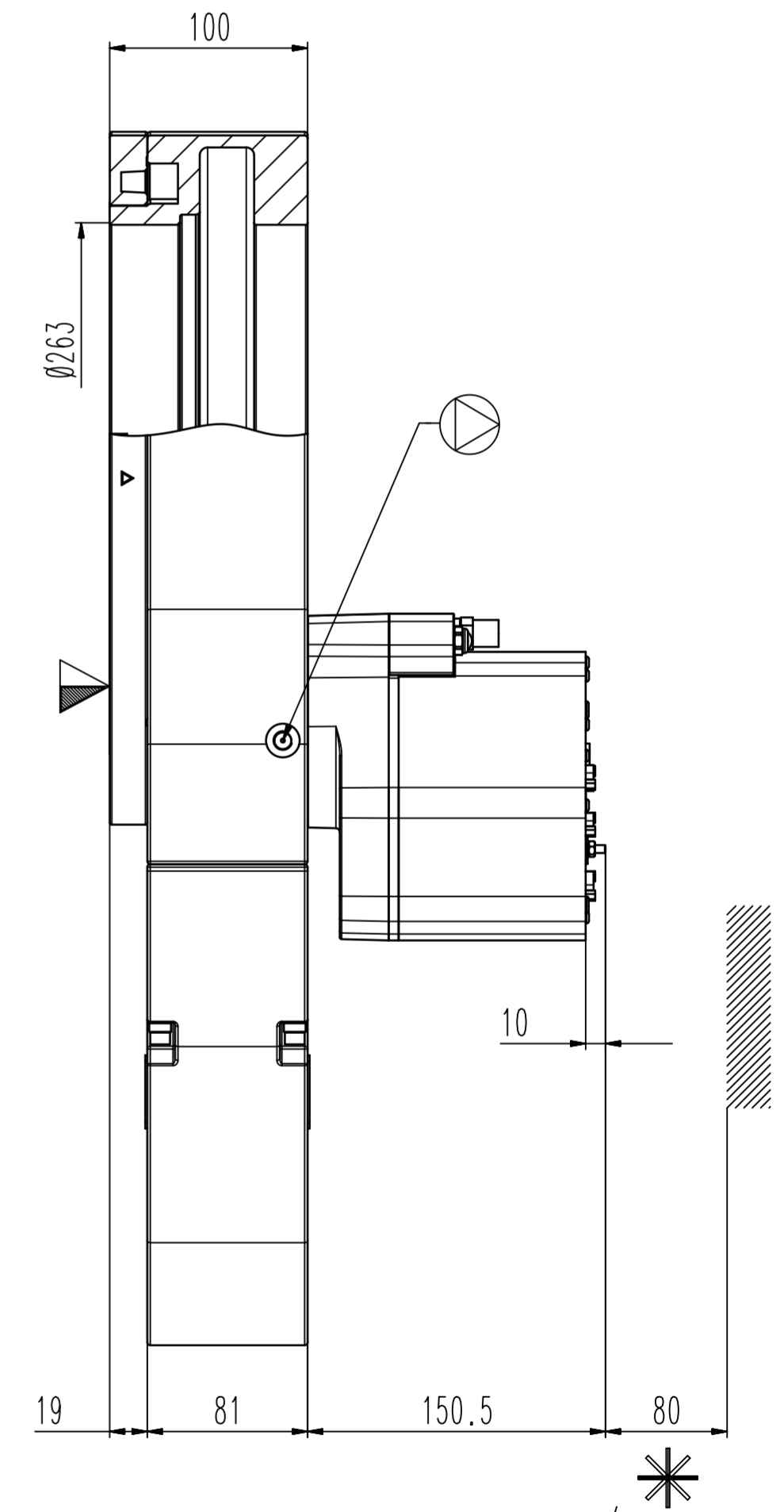
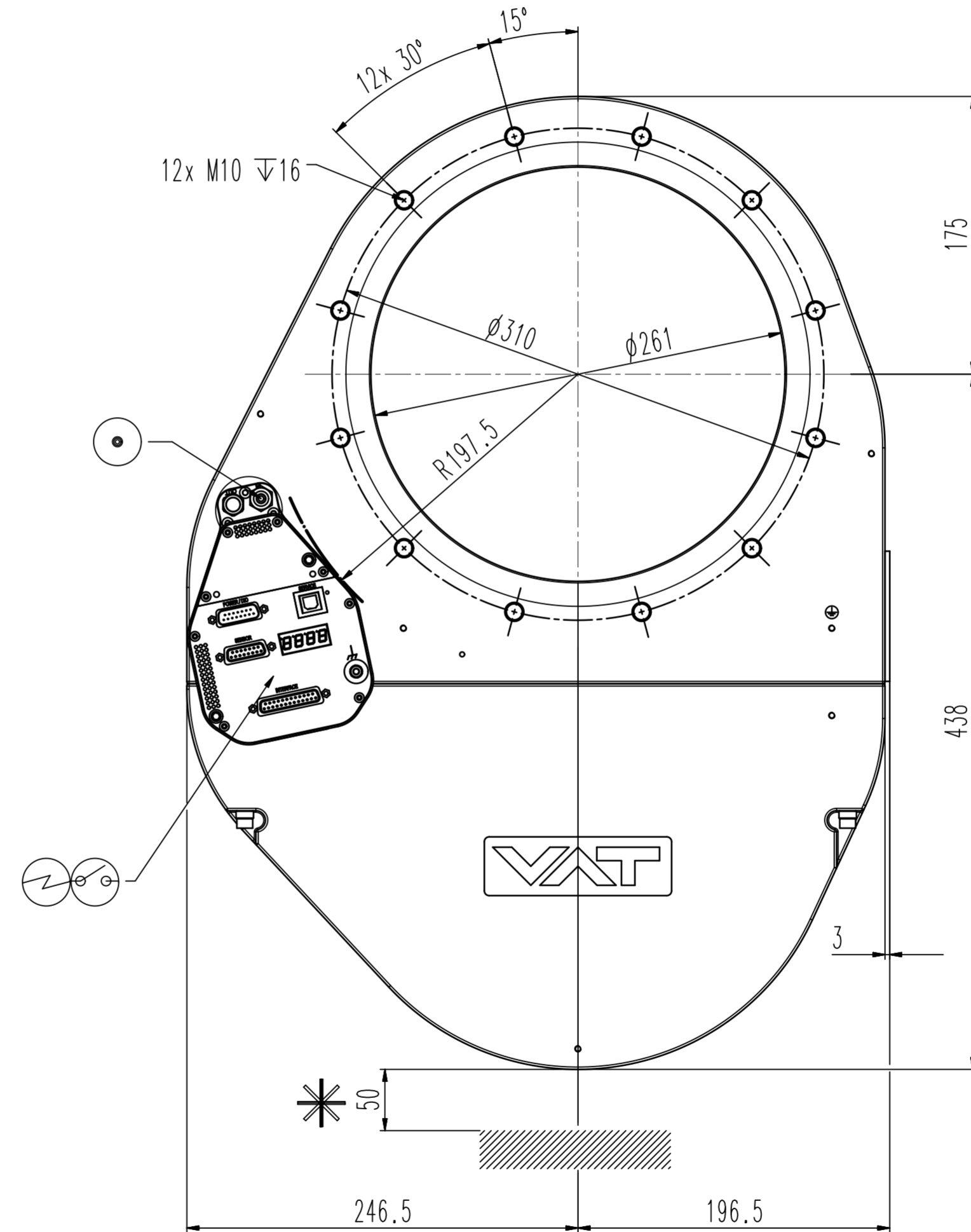
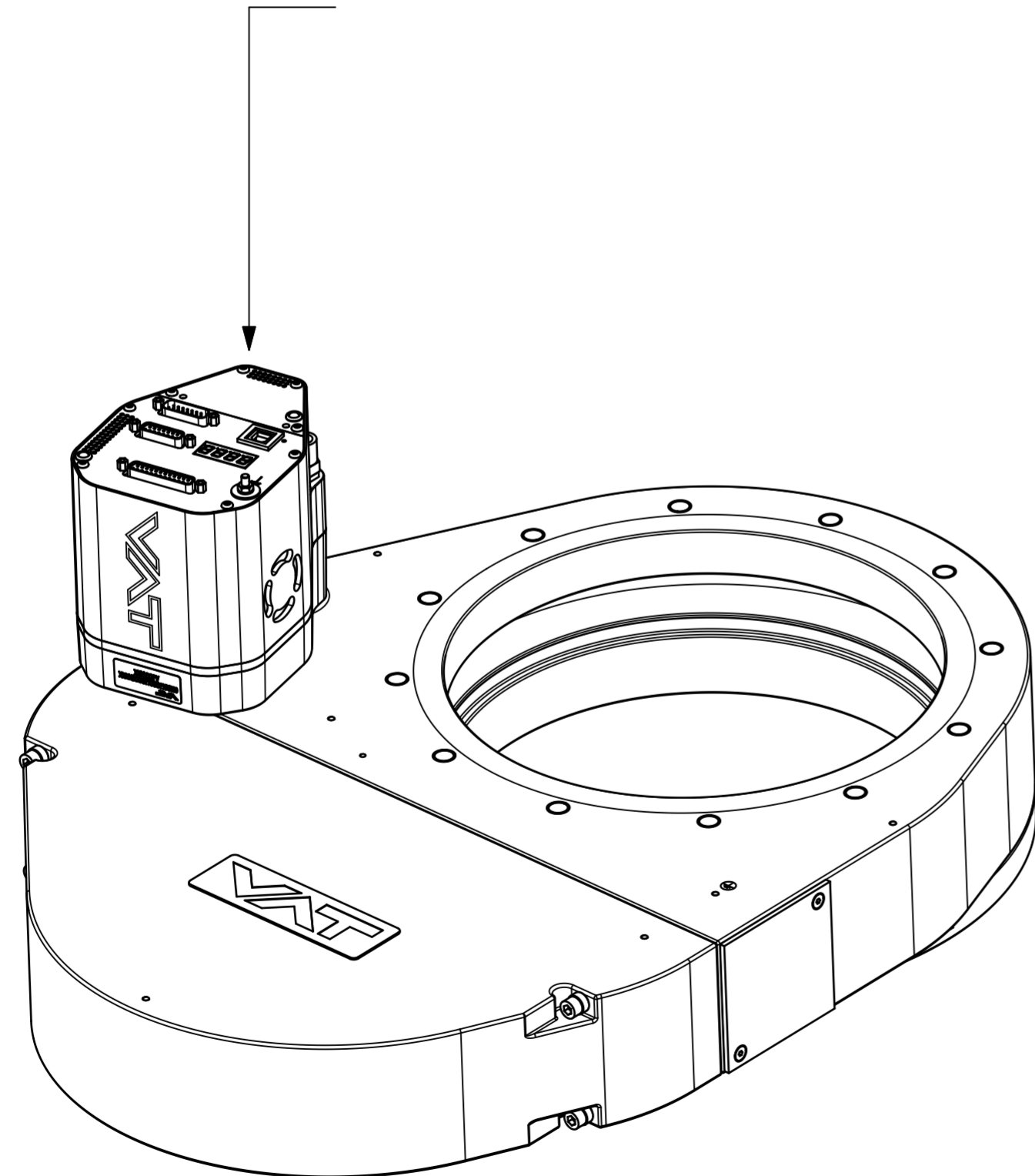

Revision
Customer number

- ▼ Seat side
- ⊙ Comp. air connection
- ⊙ Electrical connection
- ⊙ Leak detection port
- ⊙ Mech. pos. indication
- ⊙ Position indicator
- ⊙ Required for dismantling
- ⊙ Emergency actuation
- ⊙ For attachment
- ⊙ Bake-out area
- ⊙ Differential pumping port

Control pendulum valve

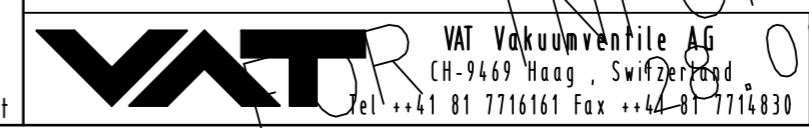

Series	Ordering No.	ISO Std
053	ONLY	
Projection E	DN	Flange
250		
Dimensional Drawing	1297566	Rev. A