

RS232 / RS485 / Logic

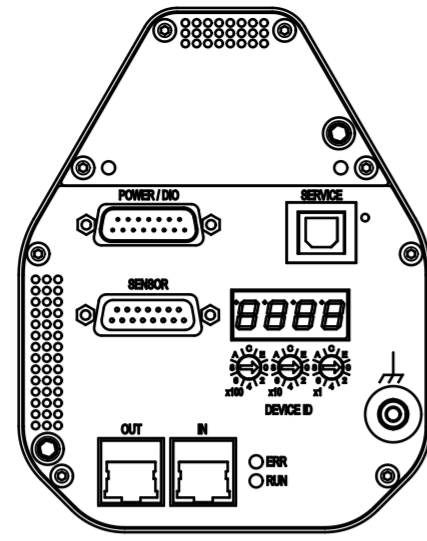

Ether CAT

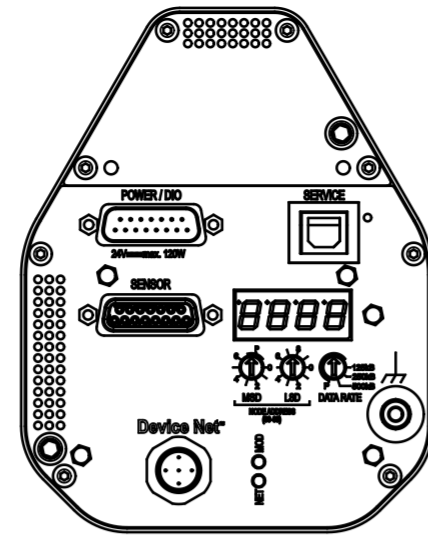

Device Net

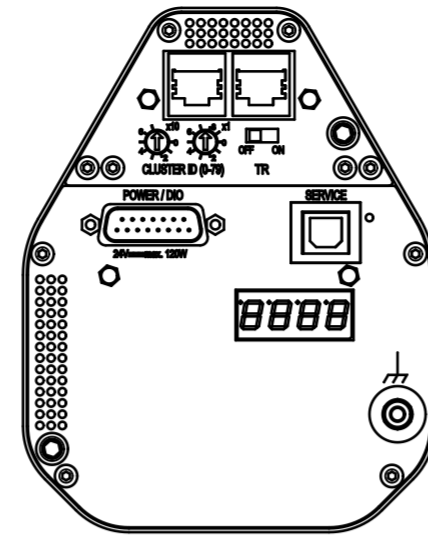

Valve Cluster Slave
(without interface)

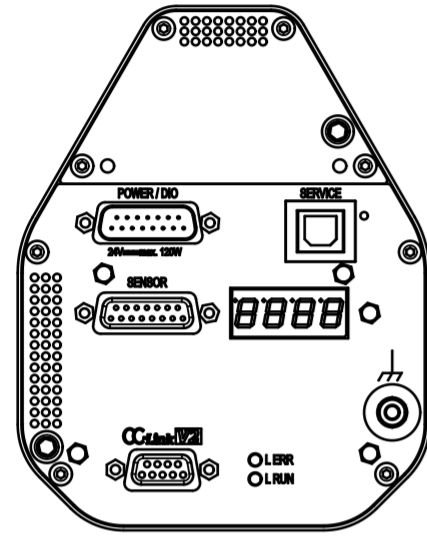

CC-Link

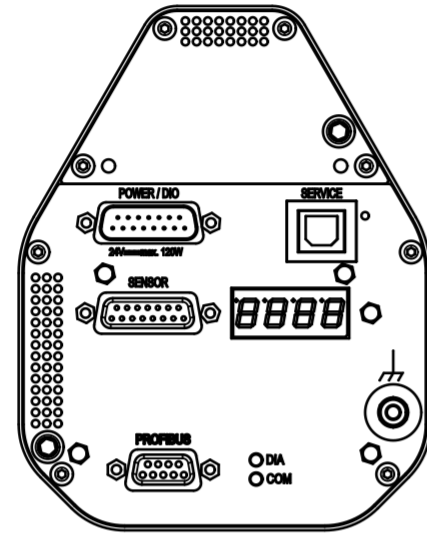

Profibus

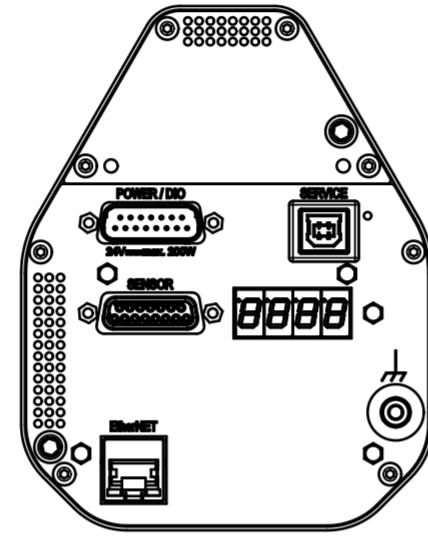

Ether Net

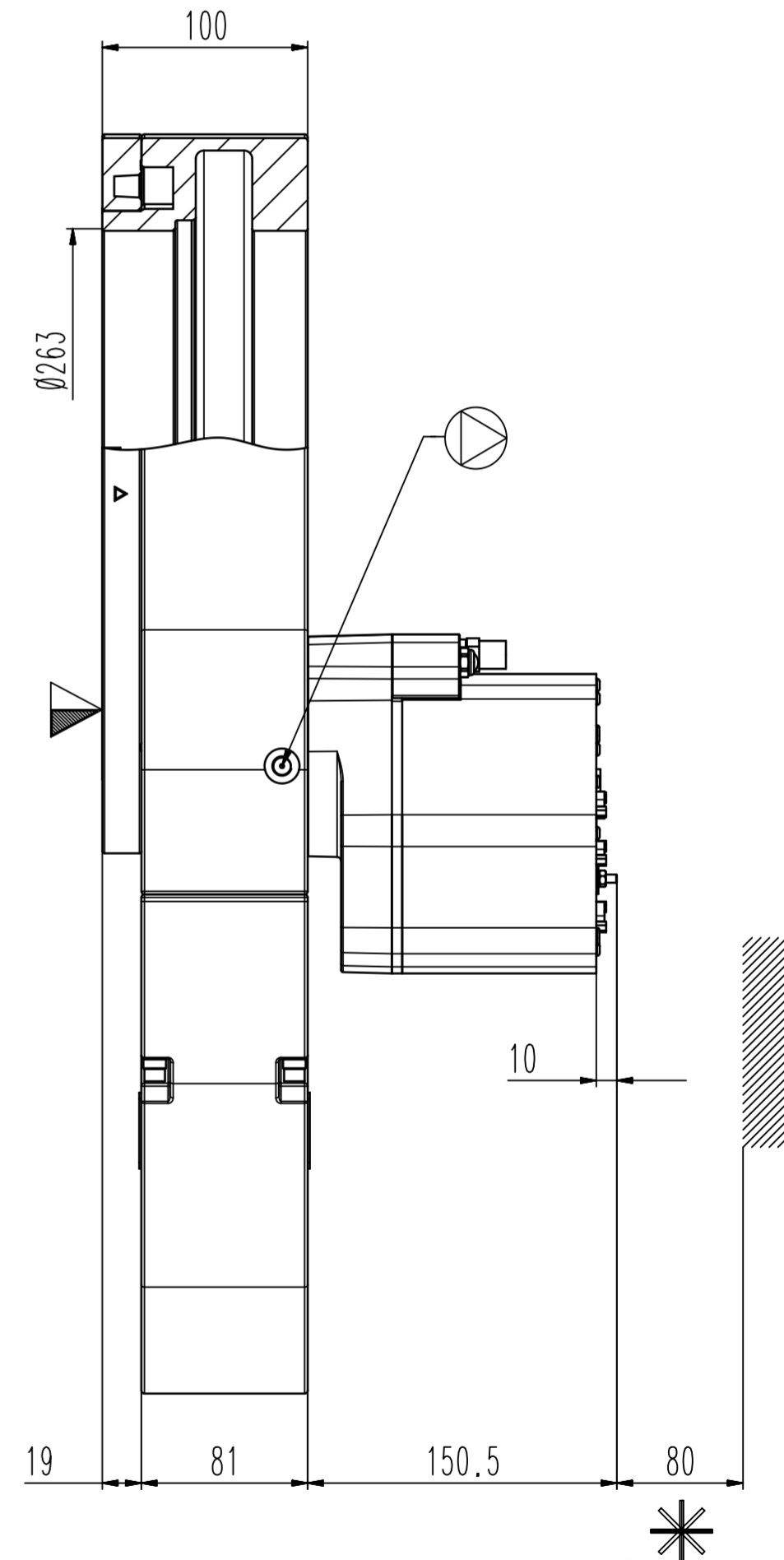

Customer number

Revision

- ▼ Seat side
- ⊙ Comp. air connection
- ⊙ Electrical connection
- ⊙ Leak detection port
- ⊙ Mech. pos. indication
- ⊙ Position indicator
- ⊙ Required for dismantling
- ⊙ Emergency actuation
- ⊙ For attachment
- ⊙ Bake-out area
- ⊙ Differential pumping port

Control pendulum valve

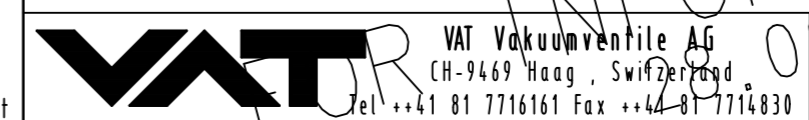

Series	Ordering No.
053	ONLY ISO Std
Projection E	DN
250	Flange
Dimensional Drawing	1297566
Rev. A	

INFORMATION ONLY