

This drawing is the property of VAT.

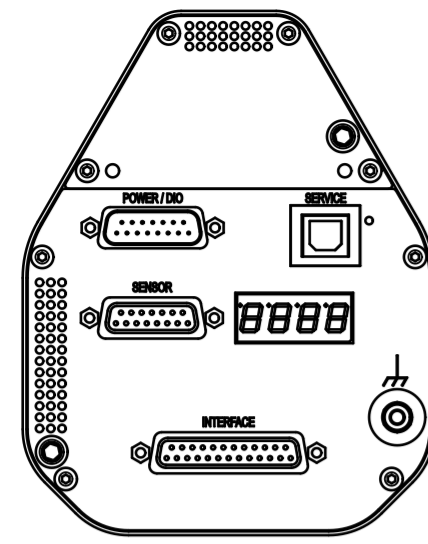

RS232 / RS485 / Logic

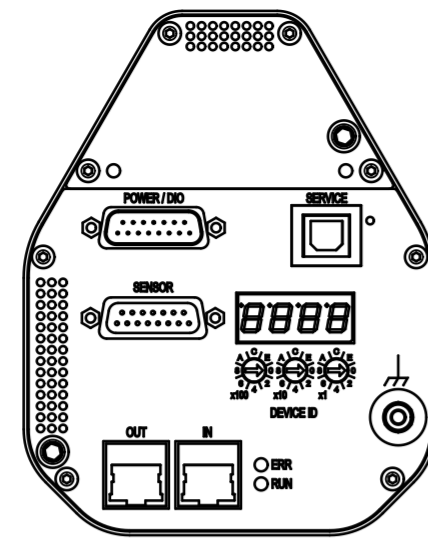

Ether CAT

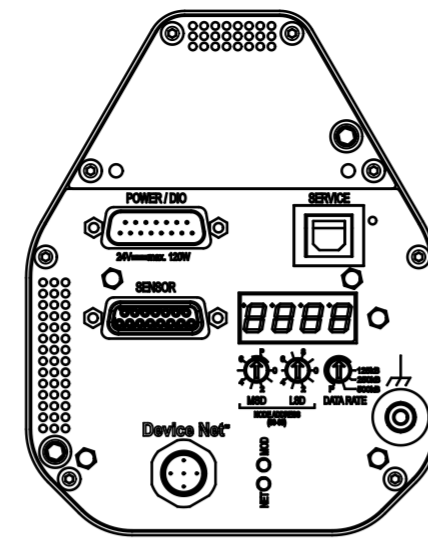

Device Net

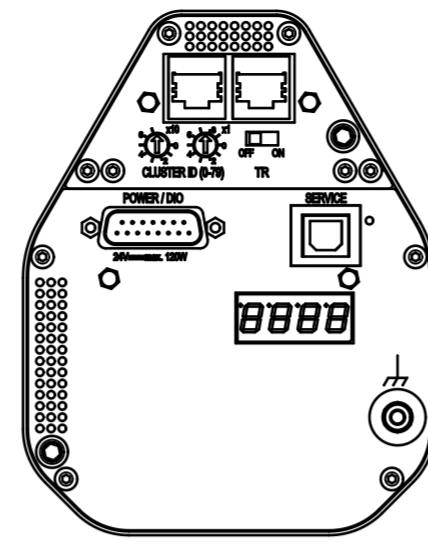

Valve Cluster Slave (without interface)

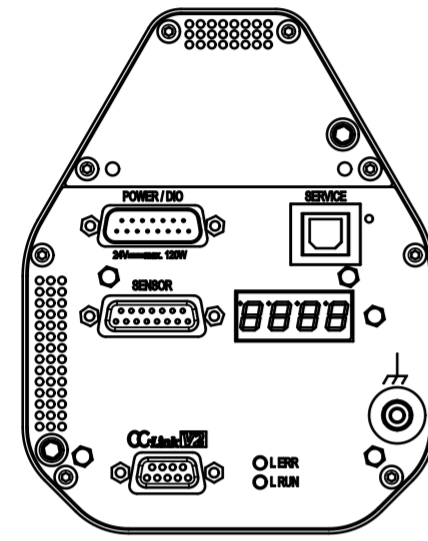

CC-Link

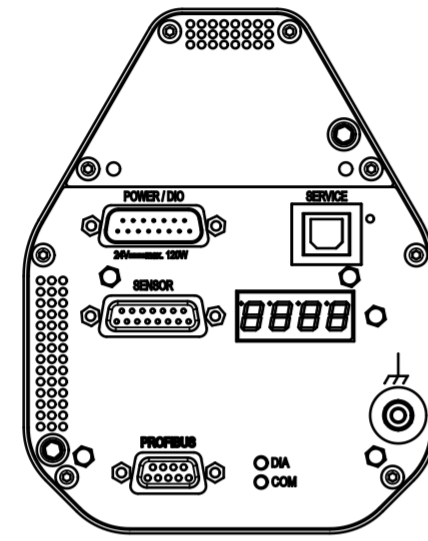

Profibus

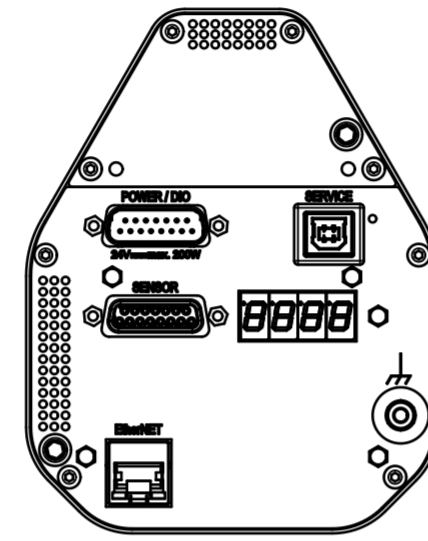

Ether Net

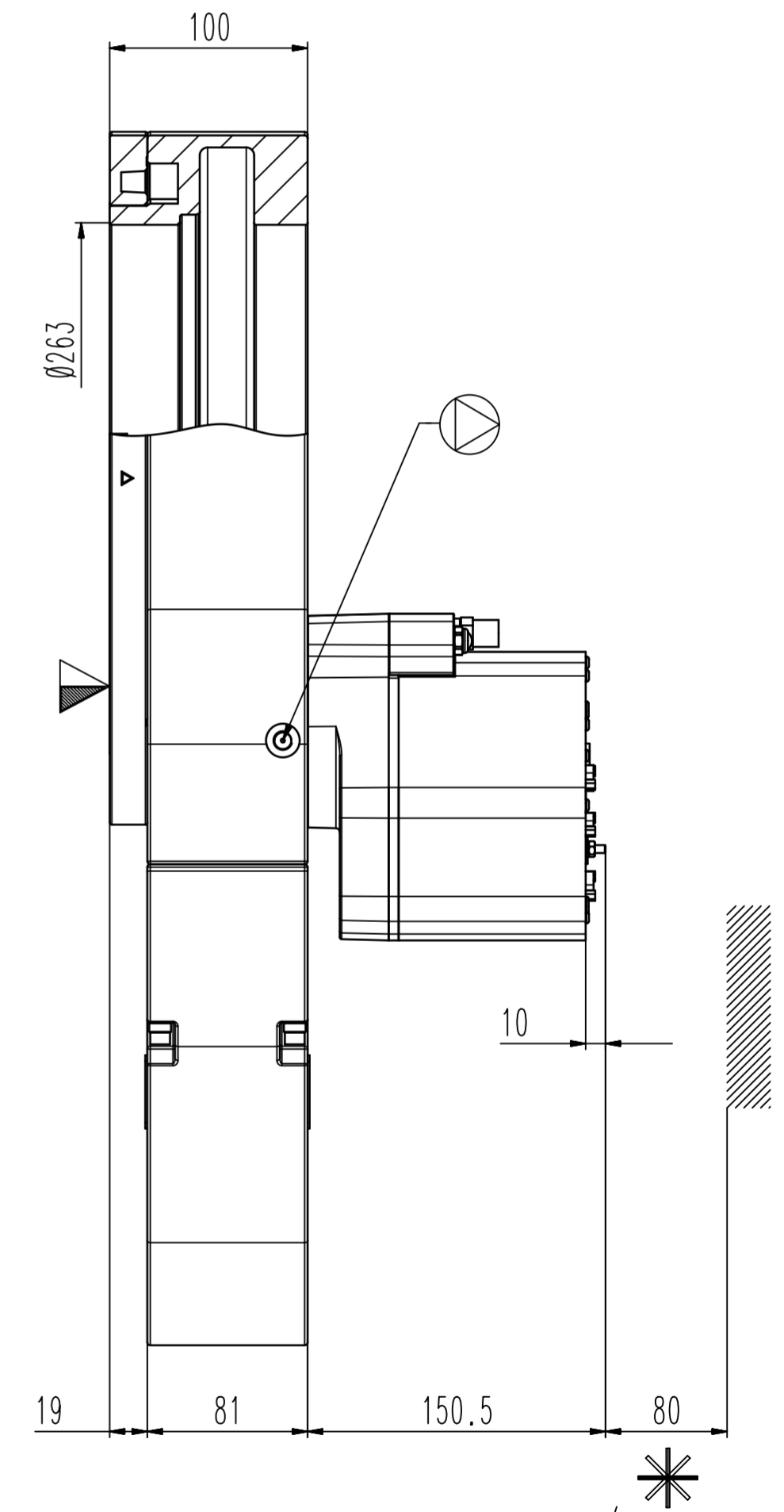

Revision  
Customer number

- ▼ Seat side
- Comp. air connection
- ⊕ Electrical connection
- ⊖ Leak detection port
- ⊙ Mech. pos. indication
- ⊙ Position indicator
- ⊙ Required for dismantling
- ⊙ Emergency actuation
- ⊙ For attachment
- ⊙ Bake-out area
- ⊙ Differential pumping port

Control pendulum valve

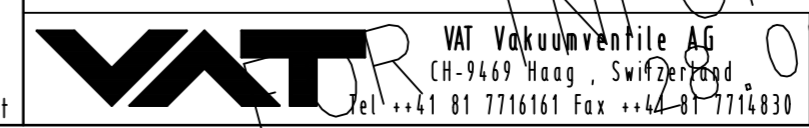

Series	Ordering No.	Rev.
053	ONLY ISO Std	A
Projection	DN	Flange
E	250	
Dimensional Drawing	1297566	