

2xM5 (10-32 UNF suitable) in air cylinder if adapter plate is removed

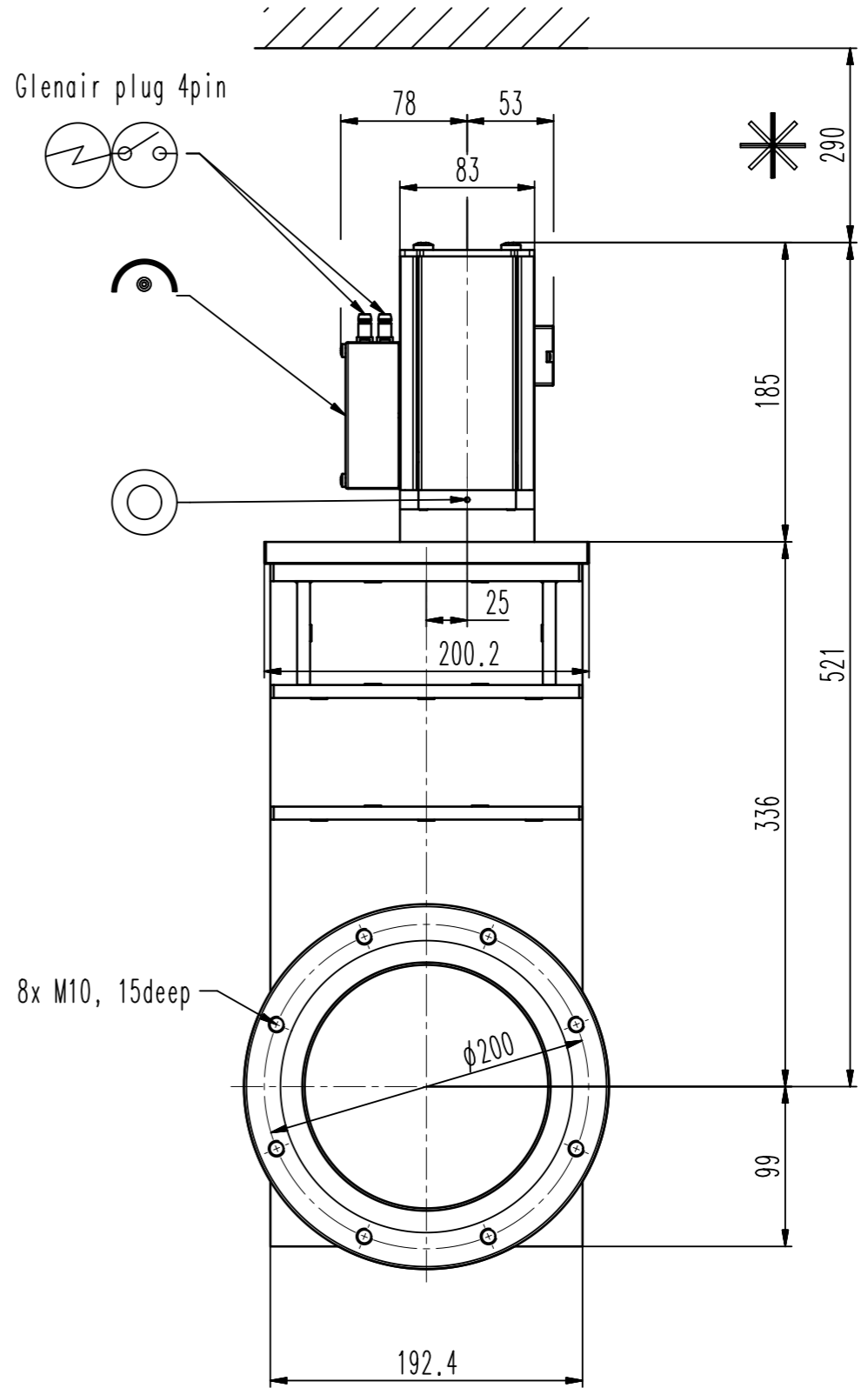
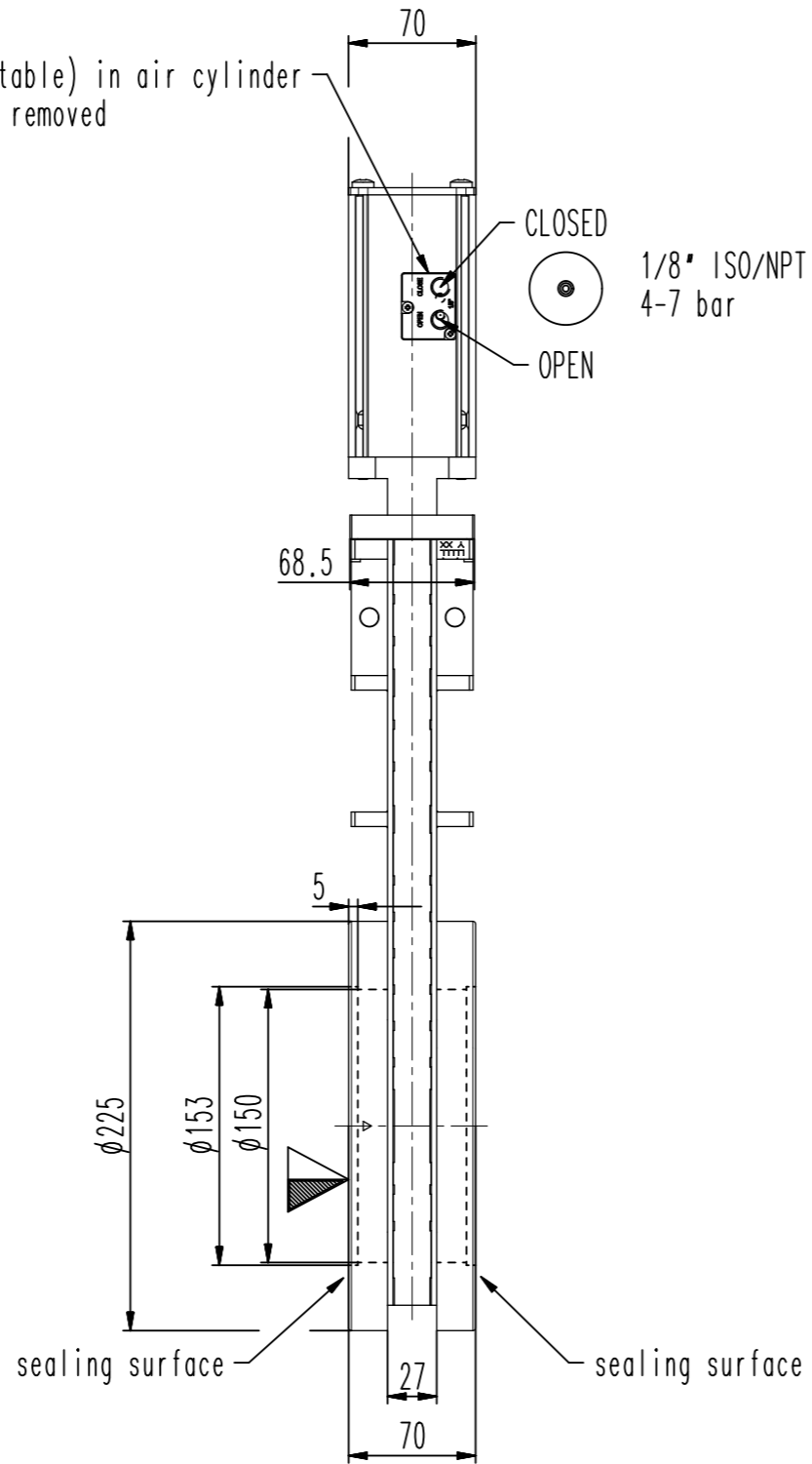

- ▼ Seat side
- ⊙ Comp. air connection
- ⊙ Electrical connection
- ⊙ Leak detection port
- ⊙ Mech. pos. indication
- ⊙ Position indicator
- ⊙ Required for dismantling
- ⊙ Emergency actuation
- ⊙ For attachment
- ⊙ Bake-out area
- ⊙ Differential pumping port

UHV gate valve

product: valve type ITER 42;



VAT Vakuumventile AG

CH-9469 Haag, Switzerland
Tel ++41 81 7716161 Fax ++41 81 7714830

Rev.-Date: 17.06.20

Visa: WAG

Series

108

Ordering No.

10844-PE24-BUE1

Projection E

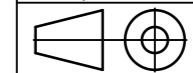

DN

160

Flange

ISO-F

Dimensional Drawing

953308

Rev.

A